

**CENTER FOR DRUG EVALUATION AND RESEARCH**

**Application Number** NDA 21-082

**FINAL PRINTED LABELING**

**APPEARS THIS WAY  
ON ORIGINAL**

# **Approved Labeling**

**(submissions of 11-9-00 and  
9-7-00)**

**APPEARS THIS WAY  
ON ORIGINAL**

**NOVARTIS**

**Drug Facts**  
 (In each tablet)  
 Acetaminophen 500 mg  
 Clemastine fumarate 0.335 mg (equivalent to 0.25 mg clemastine)  
 Pseudoephedrine HCl 30 mg  
 Antihistamine  
 Pain reliever/fever reducer

**Warnings**  
 Alcohol Warning: If you consume 3 or more alcoholic drinks daily, ask your doctor whether you should use acetaminophen or other pain relievers/fever reducers. Acetaminophen may cause liver damage.  
 Do not use if you are now taking a prescription monoamine oxidase inhibitor (MAOI) (certain drugs for depression, psychotic or emotional conditions, or Parkinson's disease), or for 2 weeks after stopping the MAOI drug. If you do not know the date you were last taking an MAOI, ask a doctor or pharmacist before taking this product.  
 Ask a doctor before use if you have:  
 - heart disease - high blood pressure - thyroid disease - diabetes - glaucoma  
 - a breathing problem such as emphysema or chronic bronchitis  
 - trouble urinating due to an enlarged prostate gland  
 Ask a doctor or pharmacist before use if you are:  
 - taking medicine or supplements  
 - under a doctor's care for any condition medical or otherwise  
 - taking other drugs on a regular basis  
 Using another product containing acetaminophen, diphenhydramine or pseudoephedrine HCl  
 When taking this product:  
 - do not use more than directed  
 - avoid alcohol, driving or operating machinery  
 - avoid smoking, and beverages that increase drowsiness  
 - do not drive a car or operate machinery if you become drowsy.

**Drug Facts (continued)**  
 Other Information  
 - Store at 20°-25°C (68°-77°F). Excursions permitted to 15°-30°C (59°-86°F) during use.  
 Avoid excessive heat.  
 Inactive ingredients: calcium silphite, glyceryl behenate, hydroxypropyl cellulose, hydroxypropyl methylcellulose, polyethylene glycol, silicon dioxide, sodium lauryl sulfate, starch, titanium dioxide.  
 Questions call 1-800-453-0881 24 hours a day, 7 days a week.

**TAVIST**  
 24 CAPLETS®  
 Allergic Rhinitis / Fever Reducer  
 Contains 24 caplets. Each caplet is not a steroid.  
 Tablets should be taken at least 12 hours apart.

Antihistamine / Nasal Decongestant / Pain Reliever / Fever Reducer

# TAVIST®

New!

Clemastine fumarate 0.335 mg (equivalent to 0.25 mg clemastine), pseudoephedrine HCl 30 mg tablets, and acetaminophen 500 mg

## ALLERGY/SINUS/ HEADACHE

- Sinus congestion & pressure
- Runny nose & sneezing
- Itchy, watery eyes
- Itchy throat

ALLERGY & SINUS RELIEF

24 CAPLETS®  
capsule-shaped tablet

**Directions**  
 Adults and children 12 years of age and over: Take 2 caplets every 6 hours as needed. Do not take more than 8 caplets in 24 hours unless directed by a doctor.  
 Children under 12 years of age: ask a doctor.

**Drug Facts (continued)**

**Drug Facts (continued)**  
**Warnings**  
 Stop use and ask a doctor if:  
 - nervousness, dizziness, or sleeplessness occurs  
 - symptoms continue or get worse  
 - a fever lasts for more than 3 days  
 - new or worsened symptoms occur  
 - nasal congestion lasts for more than 7 days  
 If pregnant or breast-feeding, ask a health professional before use.  
 Keep out of reach of children. In case of overdose, get medical help or contact a poison control center right away. (Poison medical information is printed for adults as well as children even if you do not notice any signs or symptoms.)

11/9/00

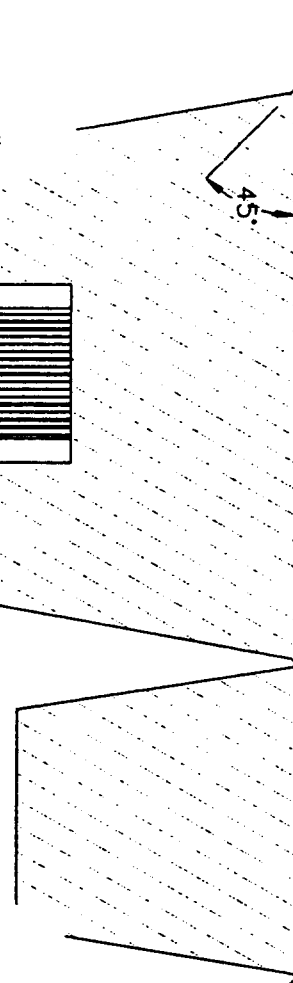

**Drug Facts**

**Active ingredients (in each tablet)**  
 Acetaminophen 500 mg  
 Chlorpheniramine HCl 30 mg (equivalent to 0.25 mg demerol)  
 Pseudoephedrine HCl 30 mg  
 Antihistamine  
 Head decongestant

**Uses** Temporarily relieves these symptoms of hay fever or other upper respiratory allergies, and common cold:  
 • sinus congestion and pressure  
 • sneezing  
 • itching of the nose or throat  
 • fever  
 • itchy watery eyes  
 • runny nose  
 • minor aches and pains

**Warnings** Ask your doctor if you are taking 2 or more alcoholic drinks daily, ask your doctor whether you should take acetaminophen or other pain relievers/fever reducers. Acetaminophen may cause liver damage.  
 Do not use if you are now taking a prescription monoamine oxidase inhibitor (MAOI) (certain drugs for depression, Parkinson's or medical conditions, or for 2 weeks after stopping the MAOI drug, if you do not know if your prescription drug contains an MAOI, ask a doctor or pharmacist before taking the product).  
 Ask a doctor before use if you have:  
 • heart disease  
 • high blood pressure  
 • thyroid disease  
 • diabetes  
 • glaucoma  
 • a breathing problem such as emphysema or chronic bronchitis  
 • trouble urinating due to an enlarged prostate gland  
 Ask a doctor or pharmacist before use if you are:  
 • taking medicine or tranquilizers  
 • under a doctor's care for any continuing medical condition  
 • taking other drugs on a regular basis  
 • using another product containing acetaminophen, chlorpheniramine HCl or pseudoephedrine HCl  
 When using this product:  
 • do not use more than directed  
 • avoid alcoholic drinks  
 • avoid driving or operating machinery  
 • avoid, alcohol, and tranquilizers may increase drowsiness  
 • do not drink more than 12 ounces of alcohol a day

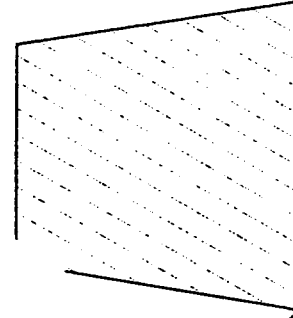
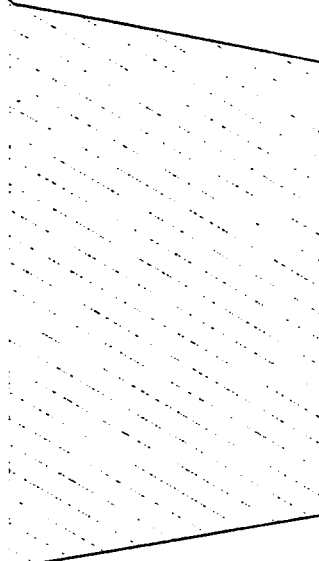

Antihistamine / Nasal Decongestant / Pain Reliever / Fever Reducer

# TAVIST®

Clonastine fumarate 0.335 mg (equivalent to 0.25 mg clonastine),  
 pseudoephedrine HCl 30 mg tablets, and acetaminophen 500 mg

**ALLERGY SINUS HEADACHE**

**48 CAPLETS\***

Temporarily Relieves: Runny Nose/Sneezing/Itchy Throat/Itchy Watery Eyes/Minor Aches and Pains

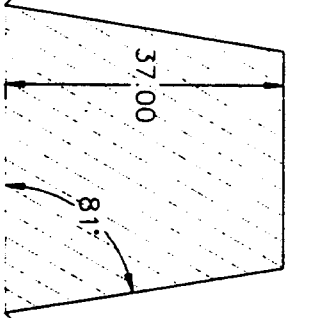

**Drug Facts (continued)**

**Other Information**  
 • Store at 20°-25°C (68°-77°) • avoid excessive heat

**Inactive ingredients** contain sodium, glycol (alcohols, substituted, methylcellulose, polyethylene glycol, silicon dioxide, sodium lauryl sulfate, stearic, titanium dioxide

**Questions** call 1-800-485-4811 24 hours a day, 7 days a week.

**NOVARTIS** Health Care Products, Inc. 11100 North Torrey Pines Road, Toluca Lake, CA 91677

©1998-99

Antihistamine / Nasal Decongestant / Pain Reliever / Fever Reducer

# TAVIST®

**New!**

Clonastine fumarate 0.335 mg (equivalent to 0.25 mg clonastine), pseudoephedrine HCl 30 mg tablets, and acetaminophen 500 mg

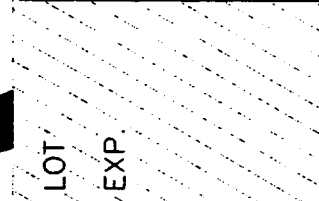

**ALLERGY/SINUS/HEADACHE**

- Sinus congestion & pressure
- Runny nose & sneezing
- Itchy, watery eyes
- Itchy throat

**48 CAPLETS\***  
 \*capsule-shaped tablet

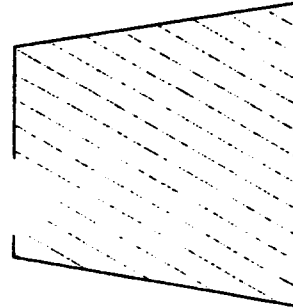

**Directions**  
 Adults and children 12 years of age and over: take 2 caplets every 6 hours as needed, not more than 8 caplets in 24 hours unless directed by a doctor.  
 Children under 12 years of age: ask a doctor.

**Warnings**  
 (continued)

• nervousness, dizziness or drowsiness occur  
 • a fever has for more than 3 days  
 • symptoms continue or get worse  
 • new or unexplained symptoms occur  
 • nasal congestion lasts for more than 7 days

If pregnant or breast-feeding, ask a health professional before use.  
 Keep out of reach of children. In case of overdose, get medical help or contact a poison control center right away. Prompt medical attention is critical for adults as well as children even if you do not notice any signs or symptoms.

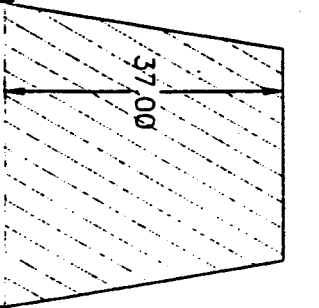

9/7/00

**NCH Response to FDA Approvable Letter Dated August 4, 2000  
NDA 21-082 – Clemastine Fumarate / Acetaminophen / Pseudoephedrine Hydrochloride  
Tablets (cont'd)**

---

**BLISTER PACK**

**Tavist Allergy/Sinus/Headache**

(clemastine fumarate 0.335 mg (equivalent to 0.25 mg clemastine), pseudoephedrine HCl 30 mg,  
and acetaminophen 500 mg tablets)

antihistamine/nasal decongestant/pain reliever/fever reducer

Manufacturer: Novartis Consumer Health, Inc.  
Summit, NJ 07901-1312

Lot Number XXXXX

Exp. Date XXXXX

***NCH Response:***

*We agree with FDA's recommended wording and have also added  
'© 2000' under Novartis (logo).*

**APPEARS THIS WAY  
ON ORIGINAL**

000959

WITHHOLD 4 PAGE (S)

Draft

Labeling