

**CENTER FOR DRUG EVALUATION AND
RESEARCH**

APPLICATION NUMBER:

208437Orig1s000

LABELING

HIGHLIGHTS OF PRESCRIBING INFORMATION

These highlights do not include all the information needed to use LONHALA™ MAGNAIR™ safely and effectively. See full prescribing information for [LONHALA MAGNAIR].

LONHALA MAGNAIR (glycopyrrolate) inhalation solution, for oral inhalation use
Initial U.S. Approval: 1961

INDICATIONS AND USAGE

LONHALA MAGNAIR is an anticholinergic indicated for the long-term, maintenance treatment of airflow obstruction in patients with chronic obstructive pulmonary disease (COPD) (1)

DOSAGE AND ADMINISTRATION

- For oral inhalation only. Do not swallow LONHALA solution. Only use LONHALA vials with MAGNAIR. (2)
- Maintenance treatment of COPD: The contents of one LONHALA vial twice-daily (2)

DOSAGE FORMS AND STRENGTHS

LONHALA Inhalation Solution is supplied as a sterile solution for inhalation in a unit-dose single-use low-density polyethylene (LDPE) vial. Each 1mL vial contains 25 mcg of glycopyrrolate (3)

CONTRAINDICATIONS

LONHALA MAGNAIR is contraindicated in patients with a hypersensitivity to glycopyrrolate or any of the ingredients (4)

WARNINGS AND PRECAUTIONS

- Do not initiate in acutely deteriorating COPD or to treat acute symptoms. (5.1)

- If paradoxical bronchospasm occurs, discontinue LONHALA MAGNAIR immediately and institute alternative therapy. (5.2)
- Worsening of narrow-angle glaucoma may occur. Use with caution in patients with narrow-angle glaucoma and instruct patients to contact a physician immediately if symptoms occur. (5.4)
- Worsening of urinary retention may occur. Use with caution in patients with prostatic hyperplasia or bladder neck obstruction and instruct patients to consult a physician immediately if symptoms occur. (5.5)

ADVERSE REACTIONS

Most common adverse reactions (incidence greater than or equal to 2.0% and higher than placebo) are dyspnea and urinary tract infection. (6.1)

To report SUSPECTED ADVERSE REACTIONS, contact Sunovion Pharmaceuticals Inc. at 1 877-737-7226 or FDA at 1-800-FDA-1088 or www.fda.gov/medwatch.

DRUG INTERACTIONS

Anticholinergics: May interact additively with concomitantly used anticholinergic medications. Avoid administration of LONHALA MAGNAIR with other anticholinergic-containing drugs. (7.2)

USE IN SPECIFIC POPULATIONS

Use in patients with severe renal impairment should be considered if the potential benefit of the treatment outweighs the risk. (8.6)

See 17 for PATIENT COUNSELING INFORMATION and FDA-approved patient labeling.

Revised: 12/ 2017

FULL PRESCRIBING INFORMATION: CONTENTS*

- INDICATIONS AND USAGE
- DOSAGE AND ADMINISTRATION
- DOSAGE FORMS AND STRENGTHS
- CONTRAINDICATIONS
- WARNINGS AND PRECAUTIONS
 - Deterioration of Disease and Acute Episodes
 - Paradoxical Bronchospasm
 - Immediate Hypersensitivity Reactions
 - Worsening of Narrow-Angle Glaucoma
 - Worsening of Urinary Retention
- ADVERSE REACTIONS
 - Clinical Trials Experience
- DRUG INTERACTIONS
 - Sympathomimetics and Steroids
 - Anticholinergics
- USE IN SPECIFIC POPULATIONS
 - Pregnancy
 - Lactation
 - Pediatric Use
 - Geriatric Use
 - Renal Impairment
 - Hepatic Impairment

- OVERDOSAGE
- DESCRIPTION
- CLINICAL PHARMACOLOGY
 - Mechanism of Action
 - Pharmacodynamics
 - Pharmacokinetics
- NONCLINICAL TOXICOLOGY
 - Carcinogenesis, Mutagenesis, Impairment of Fertility
- CLINICAL STUDIES
 - Dose Ranging Studies
 - Confirmatory Studies
- HOW SUPPLIED/STORAGE AND HANDLING
 - How Supplied
 - Storage and Handling
- PATIENT COUNSELING INFORMATION

*Sections or subsections omitted from the full prescribing information are not listed.

FULL PRESCRIBING INFORMATION

1. INDICATIONS AND USAGE

LONHALA MAGNAIR is indicated for the long-term maintenance treatment of airflow obstruction in patients with chronic obstructive pulmonary disease (COPD), including chronic bronchitis and/or emphysema.

2. DOSAGE AND ADMINISTRATION

For oral inhalation only. Do not swallow LONHALA solution. LONHALA vials should only be used with MAGNAIR [see *Overdosage (10)*].

The recommended dose of LONHALA is the inhalation of the contents of one LONHALA vial twice-daily using MAGNAIR. LONHALA vials should only be administered with MAGNAIR. Patients should be instructed on the correct use of this drug product and device.

LONHALA MAGNAIR should be administered at the same time of the day, (1 vial in the morning and 1 vial in the evening), every day. More frequent administration or a greater number of inhalations (more than 1 vial twice daily) of LONHALA MAGNAIR is not recommended.

Store LONHALA vials in the foil pouch, and only remove IMMEDIATELY BEFORE USE with MAGNAIR.

No dosage adjustment is required for geriatric patients, patients with hepatic impairment, or patients with mild to moderate renal impairment.

3. DOSAGE FORMS AND STRENGTHS

LONHALA Inhalation Solution is supplied as a sterile, clear, colorless, aqueous solution for inhalation in a unit-dose single-use low-density polyethylene (LDPE) vial. Each 1 mL vial contains 25 mcg of glycopyrrolate.

4. CONTRAINDICATIONS

LONHALA MAGNAIR is contraindicated in patients with a hypersensitivity to glycopyrrolate or any of the ingredients. [see *Warnings and Precautions (5.3)*].

5. WARNINGS AND PRECAUTIONS

5.1. Deterioration of Disease and Acute Episodes

LONHALA MAGNAIR should not be initiated in patients during acutely deteriorating or potentially life-threatening episodes of COPD. LONHALA MAGNAIR has not been studied in subjects with acutely deteriorating COPD. The initiation of LONHALA MAGNAIR in this setting is not appropriate.

LONHALA MAGNAIR should not be used as rescue therapy for the treatment of acute episodes of bronchospasm. LONHALA MAGNAIR has not been studied in the relief of acute symptoms and extra doses should not be used for that purpose. Acute symptoms should be treated with an inhaled, short-acting beta₂-agonist.

COPD may deteriorate acutely over a period of hours or chronically over several days or longer. If LONHALA MAGNAIR no longer controls symptoms of bronchoconstriction the patient's inhaled, short-acting beta₂-agonist becomes less effective; or the patient needs more inhalations of a short-acting beta₂-agonist than usual, these may be markers of deterioration of disease. In this setting, a re-evaluation of the patient and the COPD treatment regimen should be undertaken at once. Increasing the daily dose of LONHALA MAGNAIR beyond the recommended dose is not appropriate in this situation.

5.2. Paradoxical Bronchospasm

As with other inhaled medicines, LONHALA MAGNAIR can produce paradoxical bronchospasm that may be life-threatening. If paradoxical bronchospasm occurs following dosing with LONHALA MAGNAIR, it should be treated immediately with an inhaled, short-acting bronchodilator; LONHALA MAGNAIR should be discontinued immediately, and alternative therapy instituted.

5.3. Immediate Hypersensitivity Reactions

Immediate hypersensitivity reactions may occur after administration of LONHALA MAGNAIR. If signs suggesting allergic reactions occur, in particular, angioedema (including difficulties in breathing or swallowing, swelling of the tongue, lips, and face), urticaria, or skin rash, LONHALA MAGNAIR should be discontinued immediately and alternative therapy instituted.

5.4. Worsening of Narrow-Angle Glaucoma

LONHALA MAGNAIR should be used with caution in patients with narrow-angle glaucoma. Prescribers and patients should be alert for signs and symptoms of acute narrow-angle glaucoma (e.g., eye pain or discomfort, blurred vision, visual halos or colored images in association with red eyes from conjunctival congestion and corneal edema). Instruct patients to consult a physician immediately should any of these signs or symptoms develop.

5.5. Worsening of Urinary Retention

LONHALA MAGNAIR should be used with caution in patients with urinary retention. Prescribers and patients should be alert for signs and symptoms of urinary retention (e.g., difficulty passing urine, painful urination), especially in patients with prostatic hyperplasia or bladder-neck obstruction. Instruct patients to consult a physician immediately should any of these signs or symptoms develop.

6. ADVERSE REACTIONS

The following adverse reactions are described in greater detail in other sections:

- Paradoxical bronchospasm [*see Warnings and Precautions (5.2)*]
- Immediate hypersensitivity reactions [*see Warnings and Precautions (5.3)*]
- Worsening of narrow-angle glaucoma [*see Warnings and Precautions (5.4)*]
- Worsening of urinary retention [*see Warnings and Precautions (5.5)*]

6.1. Clinical Trials Experience

Because clinical trials are conducted under widely varying conditions, adverse reaction rates observed in the clinical trials of a drug cannot be directly compared to rates in the clinical trials of another drug and may not reflect the rates observed in practice.

The LONHALA MAGNAIR safety database included 2379 subjects with COPD in two 12-week efficacy studies and one 48-week long-term safety study. A total of 431 subjects received treatment with LONHALA MAGNAIR 25 mcg twice-daily (BID). The safety data described below are based on the two 12-week trials and the one 48-week trial.

12-Week Trials

LONHALA MAGNAIR was studied in two 12-week placebo-controlled trials in subjects with COPD. In these trials, 431 subjects were treated with LONHALA MAGNAIR at the recommended dose of 25 mcg twice daily. The population had a mean age of 63 years (ranging from 40 to 87 years), with 56% males, 90% Caucasian, and a mean post-bronchodilator forced expiratory volume in one second (FEV₁) percent predicted of 52% of predicted normal value (20%-80%) at study entry. The study population also included subjects with pre-existing cardiovascular disease as well as subjects with continued use of stable long-acting bronchodilator (LABA) +/- inhaled corticosteroid (ICS) and ipratropium bromide background therapy. Subjects with unstable cardiac disease, narrow-angle glaucoma, or symptomatic prostatic hypertrophy or bladder outlet obstruction were excluded from these studies.

Table 1 shows the most common adverse reactions incidence greater than or equal to 2.0% in the LONHALA MAGNAIR group and higher than placebo in the two 12-week placebo-controlled trials.

The proportion of subjects who discontinued treatment due to adverse reactions was 5% for the LONHALA MAGNAIR-treated subjects and 9% for placebo-treated subjects.

Table 1: Adverse Reactions with LONHALA MAGNAIR \geq 2.0% Incidence and Higher than Placebo

	Placebo (N=430) N (%)	LONHALA MAGNAIR 25 mcg BID (N=431) N (%)
Dyspnea	13 (3.0)	21 (4.9)
Urinary Tract Infection	6 (1.4)	9 (2.1)

Other adverse reactions defined as events with an incidence of \geq 1.0% but less than 2.0% with LONHALA MAGNAIR but more common than with placebo included the following: wheezing, upper respiratory tract infection, nasopharyngitis, oedema peripheral, and fatigue.

48-Week Trial

In a long-term open-label safety trial, 1086 subjects were treated for up to 48-weeks with LONHALA MAGNAIR 50 mcg twice-daily (N=620) or tiotropium (N=466). The demographic and baseline characteristics of the long-term safety trial were similar to those of the placebo-controlled efficacy studies described above. The adverse reactions reported in the long-term safety trial were consistent with those observed in the placebo-controlled studies of 12-weeks. Adverse reactions that occurred at a frequency greater than that seen in either active treatment dose in the pooled 12-week placebo controlled studies and \geq 2.0% were: diarrhea, edema peripheral, bronchitis, nasopharyngitis, pneumonia, sinusitis, upper respiratory tract infection, urinary tract infection, back pain, headache, Chronic Obstructive Pulmonary Disease, cough, dyspnea, oropharyngeal pain, and hypertension.

7. DRUG INTERACTIONS

7.1. Sympathomimetics and Steroids

In clinical studies, concurrent administration of glycopyrrolate and other drugs commonly used in the treatment of COPD including sympathomimetics (long and short-acting beta₂ agonists), anticholinergics (short-acting anti-muscarinic antagonists) and oral and inhaled steroids showed no increases in adverse drug reactions.

7.2. Anticholinergics

There is a potential for an additive interaction with concomitantly used anticholinergic medications. Therefore, avoid unnecessary co-administration of LONHALA MAGNAIR with other anticholinergic-containing drugs as this may lead to an increase in anticholinergic effects [*see Warnings and Precautions (5.4, 5.5) and Adverse Reactions (6)*].

8. USE IN SPECIFIC POPULATIONS

8.1. Pregnancy

Risk Summary

There are no adequate and well-controlled studies in pregnant women. LONHALA MAGNAIR should only be used during pregnancy if the expected benefit to the patient outweighs the potential risk to the fetus. Women should be advised to contact their physician if they become pregnant while taking LONHALA MAGNAIR. In animal reproduction studies, there were no teratogenic effects in Wistar rats and New Zealand White rabbits at inhaled doses approximating 1521 and 580 times, respectively, the maximum recommended human daily inhalation dose (MRHDID) based on an AUC comparison [*see Data*].

The estimated background risk of major birth defects and miscarriage for the indicated population is unknown. In the U.S. general population, the estimated background risk of major birth defects and miscarriage in clinically recognized pregnancies is 2-4% and 15-20%, respectively.

Labor or Delivery

The potential effect of LONHALA MAGNAIR on labor and delivery is unknown. LONHALA MAGNAIR should be used during labor and delivery only if the potential benefit to the patient justifies the potential risk to the fetus.

Data

Animal Data

Developmental studies in Wistar rats and New Zealand White rabbits in which glycopyrrolate was administered by inhalation during the period of organogenesis did not result in evidence of teratogenicity at exposures approximately 1521 and 580 times, respectively, the MRHDID of LONHALA MAGNAIR based on a comparison of plasma AUC levels (maternal doses up to 3.8 mg/kg/day in rats and 4.4 mg/kg/day in rabbits).

Glycopyrrolate had no effects on peri-natal and post-natal development in rats following subcutaneous exposure of approximately 1137 times the MRHDID of LONHALA MAGNAIR based on an AUC comparison (at a maternal dose of up to 1.885 mg/kg/day).

8.2. Lactation

Risk Summary

There are no data on the presence of glycopyrrolate or its metabolites in human milk, the effects on the breastfed infant, or the effects on milk production. However, in a study of lactating rats, glycopyrrolate was present in the milk [*see Data*]. The developmental and health benefits of breastfeeding should be considered along with the mother's clinical need for LONHALA MAGNAIR and any potential adverse effects on the breastfed infant from LONHALA MAGNAIR or from the underlying maternal condition.

Data

Glycopyrrolate (and its metabolites) was detected in the milk of lactating rats following a single intravenous injection of 4 mg/kg of radiolabeled glycopyrrolate.

8.4. Pediatric Use

LONHALA MAGNAIR is not indicated for use in children. The safety and efficacy of LONHALA MAGNAIR in pediatric patients have not been established.

8.5. Geriatric Use

Based on available data, no adjustment of the dosage of LONHALA MAGNAIR in geriatric patients is warranted. LONHALA MAGNAIR can be used at the recommended dose in elderly patients 75 years of age and older.

Of the total number of subjects in clinical studies of LONHALA MAGNAIR, 41% were aged 65 and older, while 8% were aged 75 and older. No overall differences in safety or effectiveness were observed between these subjects and younger subjects, and other reported clinical experience has not identified differences in responses between the elderly and younger patients, but greater sensitivity of some older individuals cannot be ruled out.

8.6. Renal Impairment

No dose adjustment is required for patients with mild and moderate renal impairment. The effects of renal impairment on the pharmacokinetics of glycopyrrolate have not been studied [*see Clinical Pharmacology (12.3)*].

8.7. Hepatic Impairment

No dose adjustment is required for patients with hepatic impairment. The effects of hepatic impairment on the pharmacokinetics of glycopyrrolate have not been studied. [*see Clinical Pharmacology (12.3)*].

10. OVERDOSAGE

An overdose of glycopyrrolate may lead to anticholinergic signs and symptoms such as nausea, vomiting, dizziness, lightheadedness, blurred vision, increased intraocular pressure (causing pain, vision disturbances, or reddening of the eye), obstipation or difficulties in voiding.

In COPD patients, orally inhaled administration of LONHALA MAGNAIR at a total daily dose of 200 mcg for 28 consecutive days (maximum of 1 mg) was well tolerated. Pharmacokinetic results from several studies conducted in COPD patients showed that a single, well tolerated dose of 1000 mcg had a C_{max} of 1534 pg/mL and AUC_{0-inf} of 5271 pg*hr/mL. These values are approximately 44 fold and 21 fold higher, respectively, than the estimated daily C_{max} of 34.5 pg/mL and AUC_{0-inf} of 255 pg*hr/mL for a 25 mcg BID dose regimen at steady-state.

11. DESCRIPTION

LONHALA MAGNAIR consists of LONHALA vials and a MAGNAIR nebulization system. LONHALA (glycopyrrolate) Inhalation Solution is a sterile, clear, colorless, aqueous solution for oral inhalation.

Glycopyrrolate USP, the active component of LONHALA Inhalation Solution, is chemically described as (3RS)-3-[(2SR)-(2-cyclopentyl-2-hydroxy-2-phenylacetyl)oxy]-1,1-dimethylpyrrolidinium bromide.

Glycopyrrolate is a synthetic quaternary ammonium compound that acts as a competitive antagonist at muscarinic acetylcholine receptors, also referred to as an anticholinergic. Glycopyrrolate, $C_{19}H_{28}BrNO_3$, is a white, odorless, crystalline powder that is soluble in water and in alcohol. It has a molecular mass of 398.33. The structural formula is:

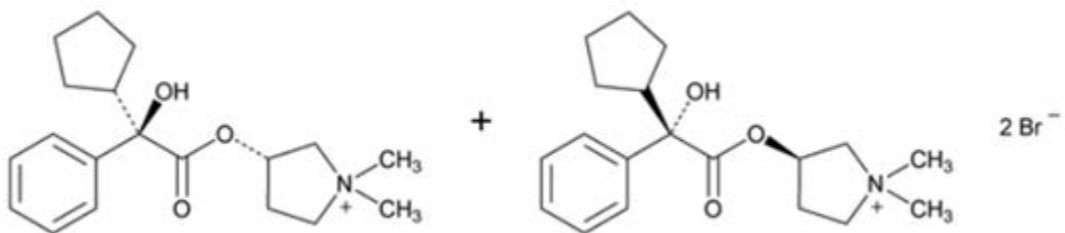

The inactive ingredients in LONHALA are: citric acid monohydrate, sodium chloride, sodium hydroxide and water for injection.

LONHALA Inhalation Solution is supplied in low-density polyethylene (LDPE) unit dose vials, each containing 1.0 mL of the solution. Each unit-dose vial contains 25 mcg of glycopyrrolate in a sterile, isotonic saline solution, pH-adjusted to 4.0 with citric acid and sodium hydroxide.

Like all other nebulized treatments, the amount delivered to the lungs will depend upon patient factors. Under standardized *in-vitro* testing per USP<1601> adult breathing pattern (500 mL tidal volume, 15 breaths per minute, and inhalation: exhalation ratio of 1:1), the mean delivered dose from the mouthpiece was approximately 14.2 mcg of glycopyrrolate (equivalent to 11.4 mcg glycopyrronium and 56.8% label claim). The mass median aerodynamic diameter (MMAD) of the nebulized aerosol particles/droplets is 3.71 μ m 95% CI (2.92 - 4.49 μ m) as determined using the Next Generation Impactor (NGI) method. The mean nebulization time was approximately 2 to 3 minutes.

12. CLINICAL PHARMACOLOGY

12.1. Mechanism of Action

Glycopyrrolate is a long-acting muscarinic antagonist, which is often referred to as an anticholinergic. It has similar affinity to the subtypes of muscarinic receptors M1 to M5. In the airways, it exhibits pharmacological effects through inhibition of M3 receptor at the smooth muscle leading to bronchodilation. The competitive and reversible nature of antagonism was shown with human and animal origin receptors and isolated organ preparations. In preclinical *in vitro* as well as *in vivo* studies, prevention of methacholine and acetylcholine induced bronchoconstrictive effects was dose-dependent and lasted longer than 24 hours. The clinical relevance of these findings is unknown. The bronchodilation following inhalation of glycopyrrolate is predominantly a site-specific effect.

12.2. Pharmacodynamics

Cardiac Electrophysiology:

In the dose ranging and confirmatory clinical studies, the administration of LONHALA MAGNAIR did not demonstrate any clinically relevant changes in cardiac function including: vital signs (heart rate, blood pressure), electrocardiograms (including QTc) and Holter monitoring. In addition, no major adverse cardiovascular events (MACE) were reported following the administration of LONHALA MAGNAIR 25 mcg in any clinical study.

12.3. Pharmacokinetics

Absorption

Following oral inhalation using MAGNAIR, glycopyrrolate was rapidly absorbed and reached peak plasma levels <20 minutes post dose.

In patients with COPD, pharmacokinetic steady-state plasma levels of glycopyrrolate were reached within one week of the start of treatment. A twice daily dose regimen leads to approximately 2-3 fold accumulation of systemic glycopyrrolate exposure at steady-state.

Distribution

The *in vitro* human plasma protein binding of glycopyrrolate was 38% to 41% at concentrations of 1 to 10 ng/mL.

Metabolism

In vitro metabolism studies show glycopyrrolate hydroxylation resulting in a variety of mono- and bis-hydroxylated metabolites and direct hydrolysis resulting in the formation of a carboxylic acid derivative (M9). Further *in vitro* investigations showed that multiple CYP isoenzymes contribute to the oxidative biotransformation of glycopyrrolate and the hydrolysis to M9 is likely to be catalyzed by members from the cholinesterase family pre-systemically and/or via first pass metabolism from the swallowed dose fraction of orally inhaled glycopyrrolate.

Elimination

After intravenous administration of [3H]-labelled glycopyrrolate to humans, the mean urinary excretion of radioactivity in 48 hours amounted to 85% of the dose. A further 5% of the dose was found in the bile.

Renal elimination of parent drug accounts for about 60 to 70% of total clearance of systemically available glycopyrrolate where as non-renal clearance processes account for about 30 to 40%. Biliary clearance

contributes to the non-renal clearance, but the majority of non-renal clearance is thought to be due to metabolism.

Drug Interactions

In vitro inhibition studies demonstrated that glycopyrrolate has no relevant capacity to inhibit CYP1A2, CYP2A6, CYP2B6, CYP2C8, CYP2C9, CYP2C19, CYP2D6, CYP2E1 or CYP3A4/5, the efflux transporters MDR1, MRP2 or MXR, and the uptake transporters OATP1B1, OATP1B3, OAT1, OAT3, OCT1 or OCT2. *In vitro* enzyme induction studies did not indicate a clinically relevant induction by glycopyrrolate for cytochrome P450 isoenzymes, or for UGT1A1 and the transporters MDR1 and MRP2.

There is potential for additive interaction with concomitantly used anticholinergic medications. Therefore, avoid coadministration of LONHALA MAGNAIR with other anticholinergic-containing drugs as this may lead to an increase in anticholinergic effects [see [Warnings and Precautions \(5.4, 5.5\)](#) and [Adverse Reactions \(6\)](#)].

Specific Populations

A population pharmacokinetic analysis of data in COPD patients indicated no clinically relevant effect of age (41 to 80 years) or body weight (40.1 to 154.8 kg) on systemic exposure to glycopyrrolate. In addition, there was no evidence of clinically significant ethnic/race effect.

Renal Impairment

The effects of renal impairment on the pharmacokinetics of glycopyrrolate have not been studied. [see [Use in Specific Populations \(8.6\)](#)]

Hepatic Impairment

The effects of hepatic impairment on the pharmacokinetics of glycopyrrolate have not been studied. Glycopyrrolate is cleared predominantly from systemic circulation by renal excretion [see [Use in Specific Populations \(8.7\)](#)].

13. NONCLINICAL TOXICOLOGY

13.1. Carcinogenesis, Mutagenesis, Impairment of Fertility

Carcinogenicity studies of glycopyrrolate did not result in an increase in the incidence of tumors in a 2-year inhalation study of glycopyrrolate in Wistar rats at doses up to 0.56 mg/kg/day, approximately 143 times the MRHDID of LONHALA MAGNAIR in adults on an AUC basis. Also, no evidence of tumorigenicity occurred in a 26-week oral (gavage) study in male and female TgrasH2 mice that received glycopyrrolate at doses up to 93.8 and 125.1 mg/kg/day, respectively, approximately 66 times the MRHDID of LONHALA MAGNAIR.

Glycopyrrolate was not mutagenic in the following genotoxicity assays: the *in vitro* Ames assay, *in vitro* human lymphocyte chromosomal aberration assay, and *in vivo* rat bone marrow micronucleus assay.

Impairment of fertility was observed in male and female Wistar rats at a subcutaneous glycopyrrolate dose of 1.88 mg/kg/day (approximately and 2035 and 1136 times, respectively, the MRHD of LONHALA MAGNAIR on an AUC basis) based upon findings of decreased implantation sites and corresponding reduction of live fetuses. No effects on fertility and reproductive performance occurred in male and female rats at a subcutaneous glycopyrrolate dose of 0.63 mg/kg/day, approximately 384 times the MRHD of LONHALA MAGNAIR on an AUC basis).

14. CLINICAL STUDIES

The safety and efficacy of LONHALA MAGNAIR were evaluated in 2 dose-ranging studies, 2 placebo-controlled confirmatory studies (12-week studies), and a 48-week long-term safety study. The efficacy of LONHALA MAGNAIR is based primarily on the dose-ranging studies in 378 subjects with COPD and the 2 placebo-controlled confirmatory studies in 1293 subjects with COPD.

14.1. Dose Ranging Studies

Dose selection for the confirmatory COPD studies for LONHALA MAGNAIR was supported by two studies. Study A was a randomized, double-blind, placebo-controlled, parallel arm study with a 28-day treatment period. The study included LONHALA MAGNAIR doses of placebo, 12.5 mcg, 25 mcg, 50 mcg, and 100 mcg twice daily. The Study demonstrated a dose-response effect on peak and trough FEV₁ over 24-hour dosing period in subjects treated with LONHALA MAGNAIR twice daily [Figure 1 (Day 1) and Figure 2 (Day 28)]. The LS mean differences in trough FEV₁ from baseline after 28 days compared to placebo for the 12.5 mcg, 25 mcg, 50 mcg, and 100 mcg twice daily doses were 0.117 L (95% CI: 0.037, 0.197); 0.128 L (95% CI: 0.048, 0.209), 0.146 L (95% CI: 0.067, 0.226), and 0.177 L (95% CI: 0.099, 0.255), respectively. In Study A, all subjects in each treatment group (N=282) had FEV₁ AUC_{0-12h} serial spirometry assessments while a subset of subjects (N=125; shown in Figure 1 and Figure 2 below) had extended FEV₁ AUC_{12-24h} assessments on Days 1 and 28.

Study B was a randomized, six-way, crossover study with 7-day treatment periods separated by 5-7-day washout periods. Study B included LONHALA MAGNAIR doses of placebo, 3 mcg, 6.25 mcg, 12.5 mcg, and 50 mcg twice daily with aclidinium bromide 400 mcg BID as an active control.

The dose-ranging results from Study A and Study B supported the evaluation of LONHALA MAGNAIR 25 mcg and 50 mcg twice-daily in the confirmatory COPD trials. The results of Study A are reported in Figure 1 below.

Figure 1: LS Mean Change from Baseline in FEV₁ (L) Over Time on Day 1 (Study A)

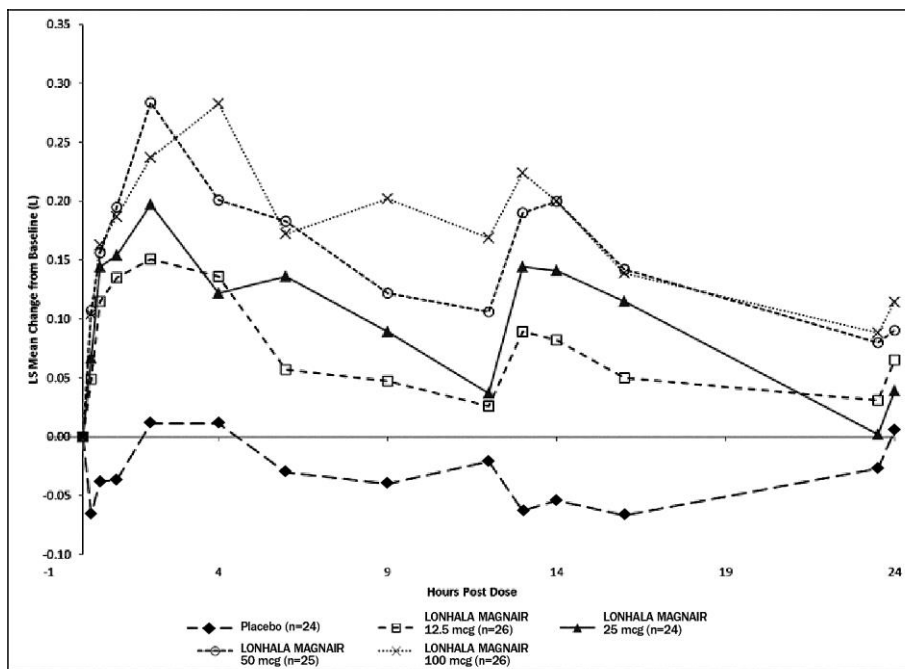
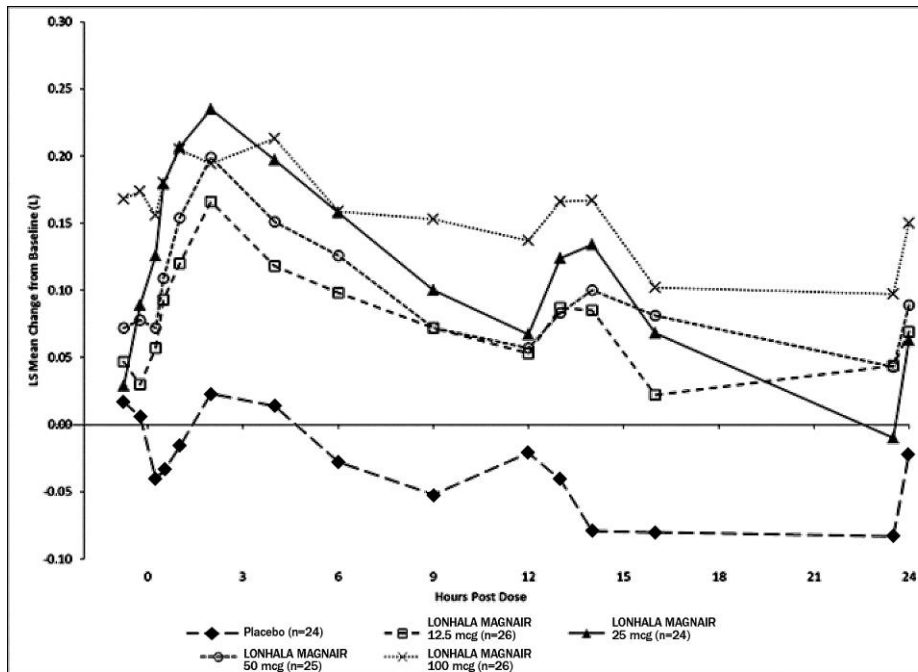

Figure 2: LS Mean Change from Baseline in FEV₁ (L) Over Time on Day 28 (Study A)



14.2. Confirmatory Studies

There were 2 confirmatory studies (Study 1 and Study 2) for LONHALA MAGNAIR. Both studies were randomized, double-blind, placebo-controlled, parallel-group 12-week studies in subjects with COPD designed to evaluate the efficacy of LONHALA MAGNAIR on lung function. These studies treated subjects who had a clinical diagnosis of COPD, were 40 years of age or older, had a history of smoking greater than or equal to 10 pack-years, a post-bronchodilator FEV₁ less than or equal to 80% of predicted, and an FEV₁/FVC ratio less than 0.7. Subjects also had pre-existing or concurrent cardiovascular disease and stable, background LABA ± ICS and SAMA use were permitted. Subjects in Study 1 and Study 2 had a mean age of 63 years, were primarily male (56%), Caucasian (90%), and current smokers (53%) with an average smoking history of 52 pack-years. At screening, the mean post-bronchodilator percent predicted FEV₁ was 52% (range: 20% to 80%), the mean post-bronchodilator percent FEV₁/FVC was 54% (range: 20% to 71%), and the mean percent reversibility was 18% (range: -33% to 86%).

Study 1 and Study 2 evaluated LONHALA MAGNAIR (glycopyrrolate) 25 mcg and 50 mcg twice-daily and placebo twice-daily. The primary endpoint was the change from baseline in trough FEV₁ at Day 84 compared with placebo. LONHALA MAGNAIR twice-daily demonstrated a larger increase in LS mean change from baseline in trough FEV₁ compared to placebo. Compared to LONHALA MAGNAIR 25 mcg twice daily, LONHALA MAGNAIR 50 mcg twice daily did not provide sufficient additional benefit on a variety of endpoints, including FEV₁, to support use of higher doses. Table 2 presents the results from Studies 1 and 2 for LONHALA MAGNAIR 25 mcg twice daily.

Table 2. LS Mean change from baseline in Trough FEV₁ (L) on Day 84 (ITT Population^{*})

Treatment	N	Change from baseline LS Mean (SE)	Comparison	Treatment Difference LS Mean (SE)	95% CI
Study 1					
LONHALA MAGNAIR 25 mcg BID	217	0.089 (0.014)	LONHALA MAGNAIR - Placebo	0.096 (0.019)	0.059, 0.133
Placebo	218	-0.008 (0.014)			
Study 2					
LONHALA MAGNAIR 25 mcg BID	214	0.092 (0.014)	LONHALA MAGNAIR - Placebo	0.081 (0.020)	0.042, 0.120
Placebo	212	0.011 (0.015)			

^{*}Study results are from a treatment policy strategy which analyzes all collected data, including data for some patients who discontinued study treatment prior to Week 12 and may have received other COPD treatment but were followed. Analyses of efficacy data measured only while on randomized blinded study treatment showed similar results.

In Study 1, serial spirometric evaluations throughout the 12-hour dosing interval were performed in a subset of subjects on Day 1 and Day 84. The spirometric curves from Study 1 on Day 1 and Day 84 are displayed in Figure 3 and Figure 4.

Figure 3: Mean Change from Baseline in FEV₁ (L) Over Time on Day 1 (Substudy Population)

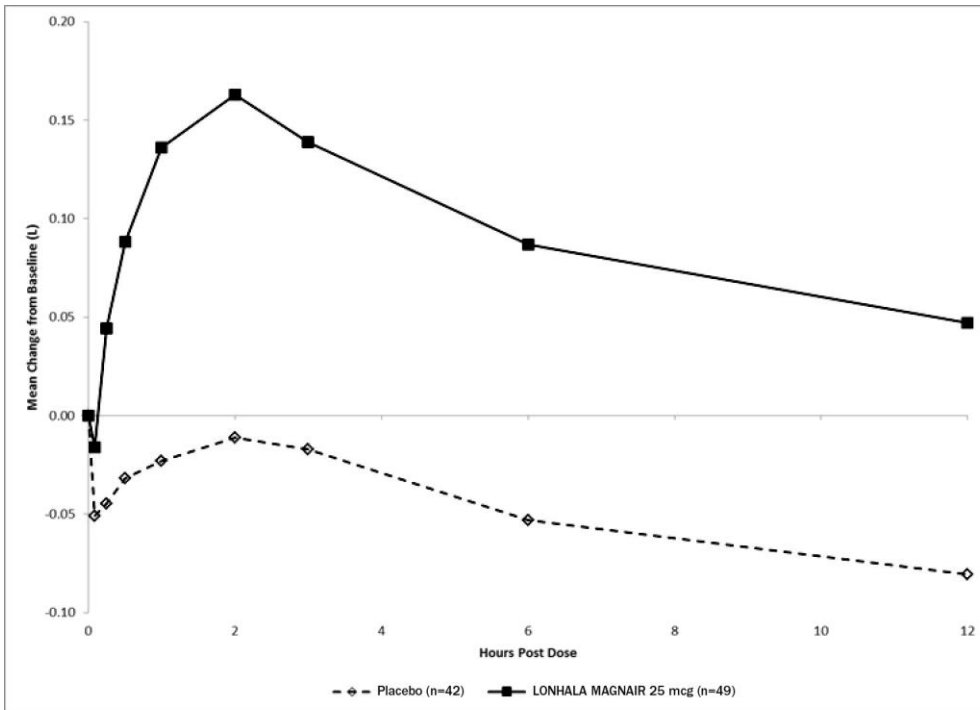
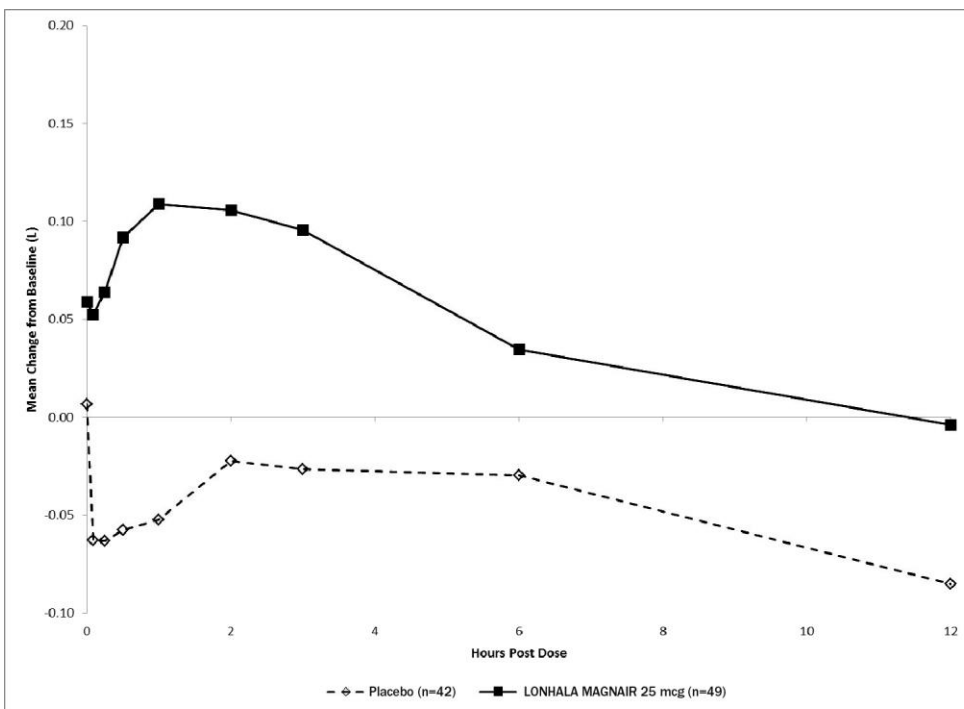

Figure 4: Mean Change from Baseline in FEV₁ (L) Over Time on Day 84 (Substudy Population)



The peak FEV₁ was defined as the highest postdose FEV₁ within the first 12 hours after morning dosing for each subject on Days 1 and 84, respectively, for the substudy population.

The mean peak FEV₁ improvement from baseline for LONHALA MAGNAIR on Day 1 and on Day 84 in the subset of subjects was 0.228 L and 0.214 L (Study 1) respectively.

The St. George's Respiratory Questionnaire (SGRQ) was assessed in Studies 1 and 2. In Study 1, the SGRQ responder rate (defined as an improvement in score of 4 or more as threshold) for the LONHALA MAGNAIR 25 mcg treatment arm was 51% compared to 40% for placebo [Odds Ratio: 1.55; 95% CI: 1.03, 2.33]. In Study 2, the SGRQ responder rate for the LONHALA MAGNAIR 25 mcg treatment arm was 41% compared to 29% for placebo [Odds Ratio: 1.72; 95% CI: 1.11, 2.67].

16. HOW SUPPLIED/STORAGE AND HANDLING

16.1 How Supplied

LONHALA MAGNAIR is supplied as a 1 mL sterile, clear, colorless, aqueous solution in low-density polyethylene (LDPE) unit-dose vials overwrapped in foil. LONHALA MAGNAIR is available in a Starter Kit containing 60 unit-dose vials packaged with one MAGNAIR, and FDA approved patient labeling. LONHALA MAGNAIR is also supplied in a Refill Kit containing 60 unit-dose vials packaged with a MAGNAIR handset refill and FDA approved patient labeling.

Package Configuration	Dosage Strength	NDC
Starter Kit with 30 day supply (30 foil pouches with 2 vials per pouch) and complete MAGNAIR Nebulizer System	25 mcg	NDC: 63402-201-00
Refill Kit with 30 day supply (30 foil pouches with 2 vials per pouch) and MAGNAIR Refill Handset	25 mcg	NDC: 63402-201-01

16.2 Storage and Handling

Store LONHALA Inhalation Solution in the protective foil pouch at 20°-25°C (68°-77°F) [see USP Controlled Room Temperature].

- LONHALA vials should be used with MAGNAIR only. Do not use MAGNAIR with any other vials.
- Store LONHALA vials in the protective foil pouch. After opening the foil pouch, unused unit-dose vials should be returned to, and stored in, the foil pouch. Once a foil pouch is opened, discard the vials if not used within 7 days. An opened unit-dose vial should be used right away. Discard any unit-dose vial if the solution is not colorless.

Always use the MAGNAIR replacement Handset parts that come with each LONHALA MAGNAIR refill prescription.

Keep out of the reach of children.

17. PATIENT COUNSELING INFORMATION

Advise the patient to read the FDA-approved patient labeling (Patient Information and Instructions for Use).

Not for Acute Symptoms: Inform patients that LONHALA MAGNAIR is not meant to relieve acute symptoms of COPD and extra doses should not be used for that purpose. Advise them to treat acute symptoms with a rescue inhaler such as albuterol. Provide patients with such medicine and instruct them in how it should be used [see *Warnings and Precautions (5.1)*].

Instruct patients to seek medical attention immediately if they experience any of the following:

- Symptoms get worse
- Need for more inhalations than usual of their rescue inhaler

Patients should not stop therapy with LONHALA MAGNAIR without physician/provider guidance since symptoms may recur after discontinuation.

Paradoxical Bronchospasm: Inform patients that LONHALA MAGNAIR can cause paradoxical bronchospasm. If paradoxical bronchospasm occurs, instruct patients to discontinue LONHALA MAGNAIR.

Worsening of Narrow-Angle Glaucoma: Instruct patients to be alert for signs and symptoms of acute narrow-angle glaucoma (e.g., eye pain or discomfort, blurred vision, visual halos or colored images in association with red eyes from conjunctival congestion and corneal edema). Instruct patients to consult a physician immediately if any of these signs or symptoms develop.

Worsening of Urinary Retention: Instruct patients to be alert for signs and symptoms of urinary retention (e.g., difficulty passing urine, painful urination). Instruct patients to consult a physician immediately if any of these signs or symptoms develop.

Instructions for Administering LONHALA MAGNAIR

It is important for patients to understand how to correctly administer LONHALA vials using MAGNAIR [see *Instructions for Use*]. Instruct patients that LONHALA vials should only be administered via MAGNAIR and MAGNAIR should not be used for administering other medications. Patients should be instructed not to inject or swallow the LONHALA solution.

Instruct patients to store LONHALA vials in the sealed foil pouch and to only open the foil pouch to remove a LONHALA vial immediately before use. Inform patients that unopened vials should be returned to the opened foil pouch for use at their next treatment and discarded if not used within 7 days or it may not be as effective.

Inform patients to use one inhalation of LONHALA MAGNAIR orally twice daily (1 vial in the morning and 1 vial in the evening) at the same time every day.

Inform patients that if they miss a dose of LONHALA MAGNAIR, they should use their next vial at the usual time. Instruct patients to not use 2 vials at one time and to not use more than 2 vials in a day. Patients should throw the plastic dispensing vials away immediately after use. Due to their small size, the vials pose a danger of choking to young children.

Inform patients treated with LONHALA MAGNAIR that a Refill Kit will be provided to them on a monthly basis. The Refill Kit will include foil pouches containing 60 vials of LONHALA (2 vials of LONHALA in each pouch; 1 vial per dose), and 1 MAGNAIR Refill Handset (containing only these replacement parts: Medication cap, Handset body, Mouthpiece, and Aerosol head; Manufacturer's instructions for use booklet).

Important: Instruct patients to throw away the old Handset parts after using 60 vials of LONHALA and use the replacement Handset parts with the next 60 vials of LONHALA.



Manufactured for Sunovion Respiratory Development Inc.,
84 Waterford Drive
Marlborough, MA 01752 USA
a direct wholly-owned subsidiary of Sunovion Pharmaceuticals Inc.
Made in Germany.

For Sunovion customer service, call 1-888-394-7377.

For medical information, call 1-800-739-0665.

To report suspected adverse events, call 1-877-737-7226.

©2017 Sunovion Pharmaceuticals Inc. All rights reserved.

PATIENT INFORMATION
LONHALA MAGNAIR (lon-HAH-luh MAGG-nair)
(glycopyrrolate)
inhalation solution, for oral inhalation use

Important: For oral inhalation only. Do not inject or swallow the LONHALA medicine. LONHALA vials are used only with the MAGNAIR device. Do not use MAGNAIR with any other medicine.

Read this Patient Information that comes with LONHALA MAGNAIR before you start using it and each time you get a refill. There may be new information. This Patient Information does not take the place of talking to your healthcare provider about your medical condition or treatment.

What is LONHALA MAGNAIR?

LONHALA MAGNAIR is an anticholinergic medicine known as glycopyrrolate.

- Anticholinergic medicines such as LONHALA MAGNAIR help the muscles around the airways in your lungs stay relaxed to prevent symptoms such as wheezing, coughing, chest tightness, and shortness of breath. This makes it hard to breathe.
- LONHALA MAGNAIR is used for maintenance treatment of Chronic Obstructive Pulmonary Disease (COPD). COPD is a long-term (chronic) lung disease that includes chronic bronchitis, emphysema, or both.
- LONHALA MAGNAIR is for long-term use and should be taken 2 times each day to improve symptoms of COPD for better breathing.
- **LONHALA MAGNAIR is not used to treat sudden symptoms of COPD.** Always have a short-acting beta₂-agonist medicine (rescue inhaler) with you to treat sudden symptoms of COPD. If you do not have a rescue inhaler, contact your healthcare provider to have one prescribed for you.
- **LONHALA MAGNAIR should not be used in children.** It is not known if LONHALA MAGNAIR is safe and effective in children younger than 18 years of age.

Do not use LONHALA MAGNAIR if you:

- are allergic to glycopyrrolate, or any of the ingredients in LONHALA MAGNAIR. Ask your healthcare provider if you are not sure. See **“What are the ingredients in LONHALA MAGNAIR?”** at the end of this Patient Information leaflet for a complete list of ingredients in LONHALA MAGNAIR.

Before using LONHALA MAGNAIR, tell your healthcare provider about all of your medical conditions, including if you:

- have kidney problems.
- have eye problems such as glaucoma. LONHALA MAGNAIR may make your glaucoma worse.
- have prostate or bladder problems, or problems passing urine. LONHALA MAGNAIR may make these problems worse.
- are pregnant or plan to become pregnant. It is not known if LONHALA MAGNAIR can harm your unborn baby.
- are breastfeeding or plan to breastfeed. It is not known if the medicine in LONHALA MAGNAIR passes into your breast milk and if it can harm your baby. You and your healthcare provider should decide if you will take LONHALA MAGNAIR or breastfeed.
- are allergic to LONHALA MAGNAIR or any of its ingredients or, any other medicines.

Tell your healthcare provider about all the medicines you take, including prescription medicines and, over-the-counter medicines, vitamins, and herbal supplements. LONHALA MAGNAIR may affect the way other medicines work, and other medicines can affect how LONHALA MAGNAIR works. Using LONHALA MAGNAIR with other medicines may cause serious side effects.

Especially tell your healthcare provider if you take anticholinergics (including umeclidinium, tiotropium, ipratropium, acclidinium, glycopyrrolate).

Know the medicines you take. Keep a list of your medicines with you and show it to your healthcare provider and pharmacist when you get a new medicine.

How should I use LONHALA MAGNAIR?

Read the step-by-step instructions for using LONHALA MAGNAIR at the end of this Patient Information leaflet and the manufacturer's instructions for use booklet. The manufacturer's instructions for use booklet provides complete information about how to put together (assemble), prepare, use, care for, and trouble-shoot your MAGNAIR nebulizer system.

- **Do not** use LONHALA MAGNAIR unless your healthcare provider has taught you how to use the device and you understand how to use it correctly.
- Use LONHALA MAGNAIR exactly as your healthcare provider tells you to use it. Do not use LONHALA MAGNAIR more often than prescribed for you.
- Only use LONHALA vials with the MAGNAIR device.
- **Do not** inject or swallow the LONHALA medicine.
- Inhale the medicine in 1 LONHALA vial through the MAGNAIR device 2 times each day (1 vial in the morning and 1 vial in the evening) at the same time each day.
- If you miss a dose of LONHALA MAGNAIR, take your next dose at your usual time.
 - **Do not** use 2 vials at 1 time.
 - **Do not** use more than 2 vials in a day.
- **Do not** stop using LONHALA MAGNAIR or other medicines to control or treat your COPD unless told to do so by your healthcare provider because your symptoms might get worse. Your healthcare provider will change your medicines as needed.
- **Call your healthcare provider or get emergency medical care right away if** your breathing problems worsen with LONHALA MAGNAIR, you need to use your rescue medicine more often than usual, or your rescue inhaler medicine does not work as well for you at relieving your symptoms.

What are the possible side effects of LONHALA MAGNAIR?

LONHALA MAGNAIR can cause serious side effects, including:

- **sudden shortness of breath immediately after use of LONHALA MAGNAIR. Sudden shortness of breath may be life-threatening.** If you have sudden breathing problems immediately after inhaling your medicine, stop taking LONHALA MAGNAIR and call your healthcare provider or go to the nearest hospital emergency room right away.
- **serious allergic reactions.** Stop using LONHALA MAGNAIR and call your healthcare provider or get emergency medical care right away if you get any of the following symptoms of a serious allergic reaction:
 - rash
 - hives
 - swelling of the tongue, lips, and face
 - difficulty breathing or swallowing
- **new or worsened eye problems including acute narrow-angle glaucoma.** Acute narrow-angle glaucoma can cause permanent loss of vision if not treated. Symptoms of acute narrow-angle glaucoma may include:
 - eye pain or discomfort
 - red eyes
 - blurred vision
 - seeing halos or bright colors around lights
 - nausea or vomiting

If you have any of these symptoms, stop taking LONHALA MAGNAIR and call your healthcare provider right away before using another dose.

- **new or worsened problems emptying your bladder (urinary retention).** People who use LONHALA MAGNAIR may develop new or worsened urinary retention. Urinary retention can be caused by a blockage in your bladder. Urinary retention can also happen in men who have a larger than normal prostate.

Symptoms of urinary retention may include:

- difficulty urinating
- painful urination
- urinating frequently
- urination in a weak stream or drips

If you have any of these symptoms, stop taking LONHALA MAGNAIR and call your healthcare provider right away before taking another dose.

Common side effects of LONHALA MAGNAIR include shortness of breath, and urinary tract infections.

These are not all of the possible side effects of LONHALA MAGNAIR.

Call your doctor or pharmacist for medical advice about side effects. You may report side effects to FDA at 1-800-FDA-1088.

How should I store LONHALA MAGNAIR?

- Store LONHALA vials in the protective foil pouch at room temperature between 68°F and 77°F (20°C and 25°C).
- LONHALA vials should be used with the MAGNAIR device only. Do not use MAGNAIR with any other medicine.

After opening the protective foil pouch, unused LONHALA vials should be returned to, and stored in, the opened foil pouch. Once a foil pouch is opened, discard the vials if not used within 7 days.

- An opened LONHALA vial should be used right away.
- Throw away the LONHALA vial right away after use.
- The medicine in the LONHALA vial should be colorless. Throw away the LONHALA vial if the medicine is not colorless.
- Always use the MAGNAIR replacement Handset parts that come with each LONHALA MAGNAIR refill prescription.
- **Keep LONHALA MAGNAIR and all medicines out of the reach of children.**

General information about the safe and effective use of LONHALA MAGNAIR.

Medicines are sometimes prescribed for purposes other than those listed in a Patient Information leaflet. Do not use LONHALA MAGNAIR for a condition for which it was not prescribed. Do not give LONHALA MAGNAIR to other people, even if they have the same symptoms you have. It may harm them.

You can ask your healthcare provider or pharmacist for information about LONHALA MAGNAIR that is written for healthcare professionals.

What are the ingredients in LONHALA MAGNAIR?

Active ingredient: glycopyrrolate

Inactive ingredients: citric acid monohydrate, sodium chloride, sodium hydroxide and water for injection.



Manufactured for:
Sunovion Respiratory Development Inc.,
a wholly-owned subsidiary of Sunovion Pharmaceuticals Inc.
Made in Germany.

©2017 Sunovion Pharmaceuticals Inc. All rights reserved.

For more information, go to www.LONHALA.com or call Sunovion Customer Service at 1-888-394-7377.

This Patient information has been approved by the U.S. Food and Drug Administration Issued: December 2017

INSTRUCTIONS FOR USE
LONHALA MAGNAIR (lon-HAH-luh MAGG-nair)
(glycopyrrolate)
inhalation solution, for oral inhalation use

Read this Instructions for Use leaflet and the manufacturer's instructions for use booklet before you start using LONHALA MAGNAIR and each time you get a refill. There may be new information. This information does not take the place of talking to your healthcare provider about your medical condition or treatment. If you have any questions, ask your healthcare provider or pharmacist. The manufacturer's instructions for use booklet provides complete information about how to put together (assemble), prepare, use, care for, and trouble-shoot your MAGNAIR nebulizer system.

Your LONHALA MAGNAIR:

MAGNAIR is a nebulizer system to be used by the patient, caregiver, or healthcare provider to deliver the medicine LONHALA. LONHALA MAGNAIR consists of both the MAGNAIR nebulizer system and the medicine LONHALA.

The following supplies come with your LONHALA MAGNAIR:

Starter Kit: Foil pouches containing 60 vials of LONHALA (2 vials of LONHALA in each pouch; 1 vial per dose), Instructional video, and 1 MAGNAIR Nebulizer System with carrying bag (including Manufacturer's instructions for use booklet and Quick Reference Guide)(see the figure below).

Refill Kit: Foil pouches containing 60 vials of LONHALA (2 vials of LONHALA in each pouch; 1 vial per dose), and 1 MAGNAIR refill Handset (containing only these replacement parts: Medication cap, Mouthpiece, and Aerosol head; Manufacturer's instructions for use booklet).

Important: Throw away the old Handset parts after using 60 vials of LONHALA and use the replacement Handset parts in the Refill Kit with the next 60 vials of LONHALA.

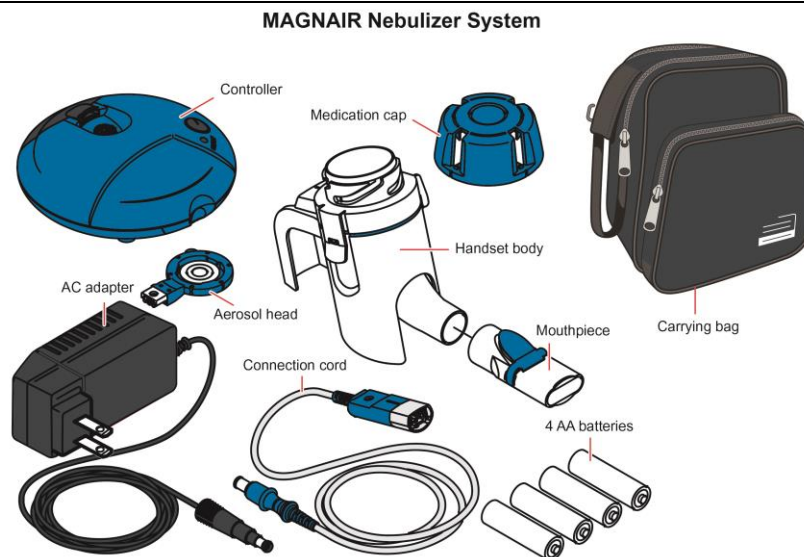

Important: Check to make sure that your MAGNAIR nebulizer system is working properly before you use LONHALA MAGNAIR for the first time. See the manufacturer's instructions for use that come with your MAGNAIR nebulizer system.

Steps for Using Batteries with MAGNAIR

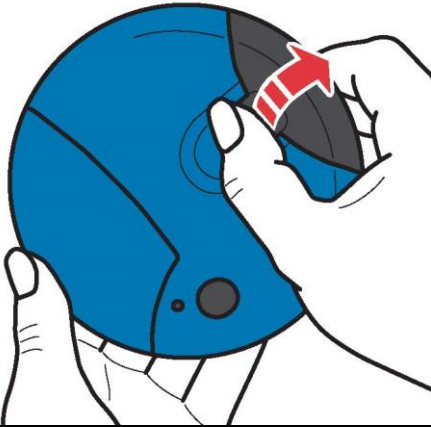

Step 1: Open the battery door on the controller. Placing your thumb on the black tab of the battery door and firmly pushing the tab to open the door.

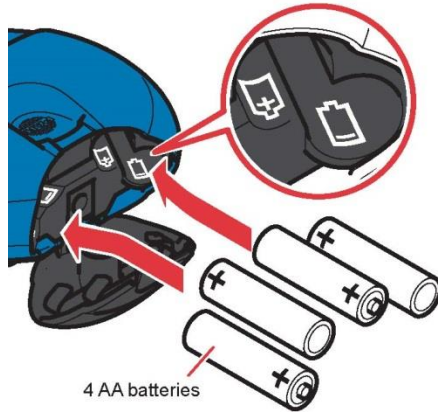

Step 2: Put 4 AA batteries in the Controller as shown.



Step 3: Close the battery door. You may hear a “click”.
Important: Make sure to have an extra set of batteries with you at all times if you choose not to use the AC adapter.

Steps for Using the AC Adapter with MAGNAIR

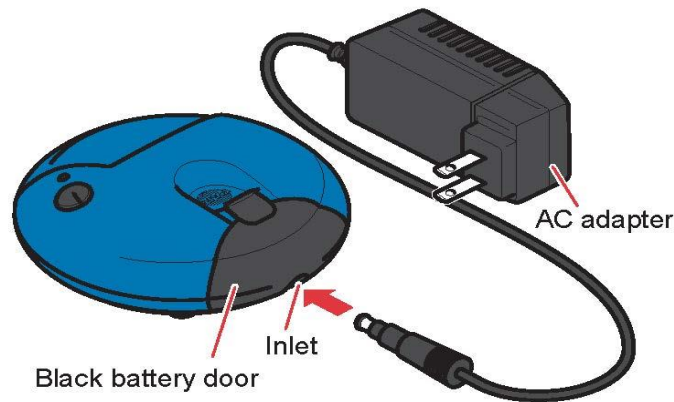

Step 1: Plug the AC adapter into the Inlet on the battery door of the Controller.
Step 2: Plug the AC adapter into the wall outlet.

Assembling Your MAGNAIR

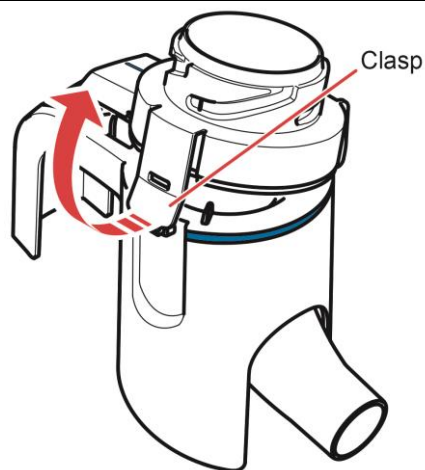

Step 1: Wash your hands.
Step 2: Open the top of the Handset body by lifting the clasp.

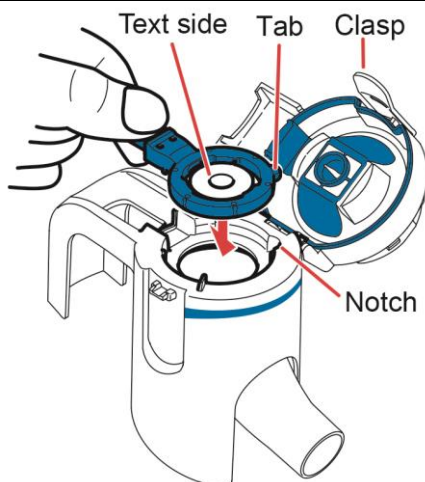

Step 3: Insert the Aerosol head into the Handset body as shown. **Do not** touch the center of the Aerosol head. Notice that the Aerosol head has a small tab on the side. Align the small tab with the matching notch in the Handset body.

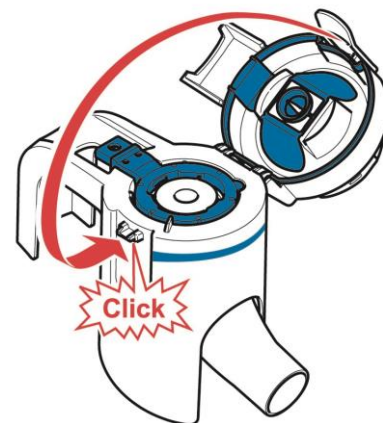

Step 4: Close the Handset body. You may hear a “Click”.

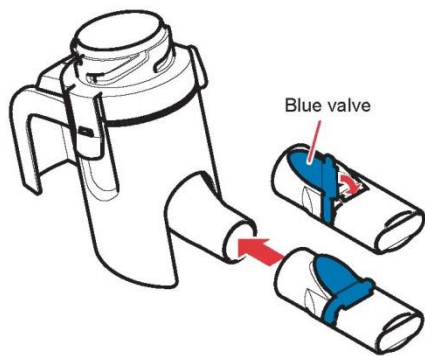

Step 5: Attach the Mouthpiece to the Handset body. Make sure the Blue valve is pressed down.

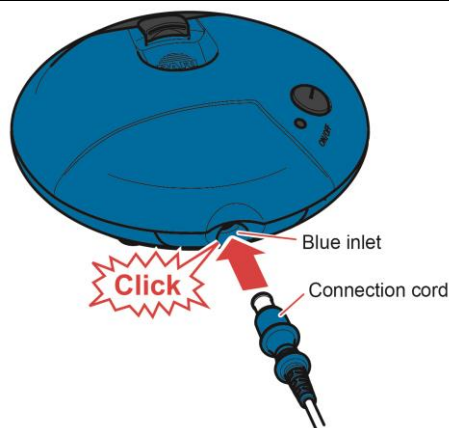

Step 6: Connect the Controller to the Handset body using the Connection cord. You may hear a “Click”.

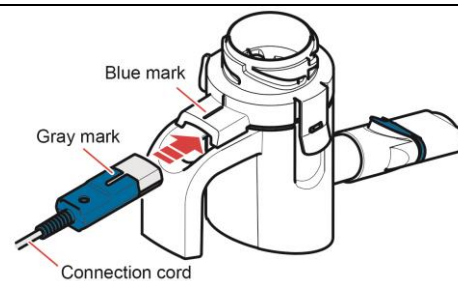

Step 7: Connect the Controller to the Handset body using the Connection cord as shown.

Using LONHALA MAGNAIR

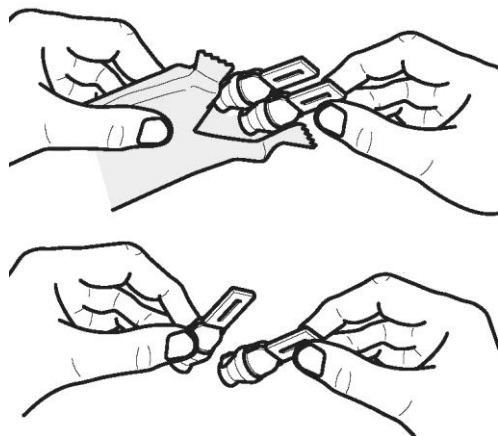

Step 1: Open the foil pouch, enough to remove the 2 LONHALA vials and separate them. Return 1 vial to the opened foil pouch and store in the carrying bag to be used at the next treatment. Discard the vial if not used within 7 days.

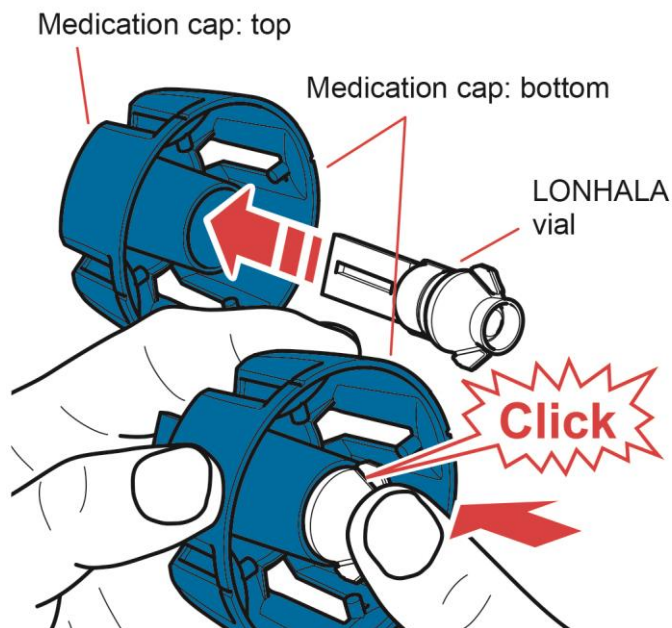

Step 2: Insert one LONHALA vial into the bottom of the Medication cap until it "Clicks".

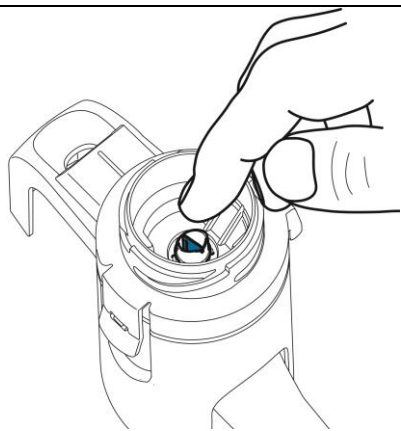

Important: Do not touch the part of the Handset body that pierces the vial.

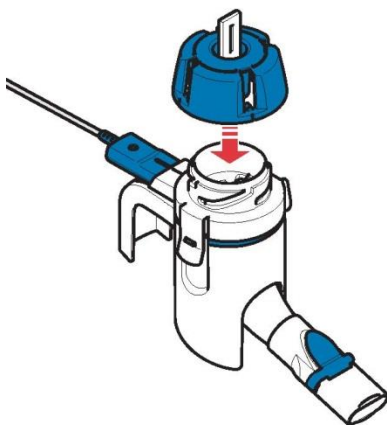

Step 3: Make sure the Aerosol head is installed before attaching the Medication cap because your medicine could leak and you will not get your full treatment. Place the Medication cap with LONHALA vial on the top of the Handset body.

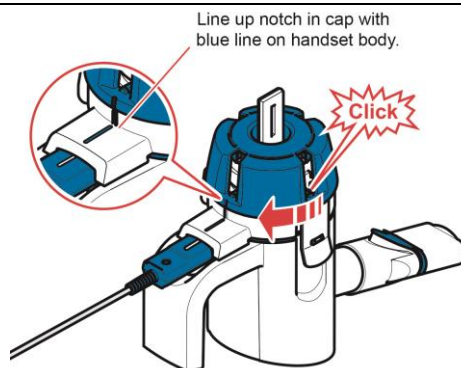

Step 4: To attach the Medication cap to the Handset body, turn the Medication cap in a clockwise direction as shown, until you hear a "Click". The notch in the Medication cap (at the base of the opening) should line up with the blue line on the Handset body.

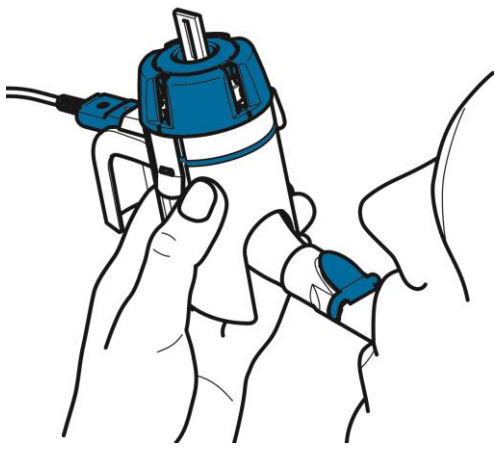

Step 5: Insert the Mouthpiece into your mouth.
Important: Do not tilt the Handset, loosen or remove the Medication cap, or unclasp the Handset body until the treatment is complete because you will not get your full treatment.

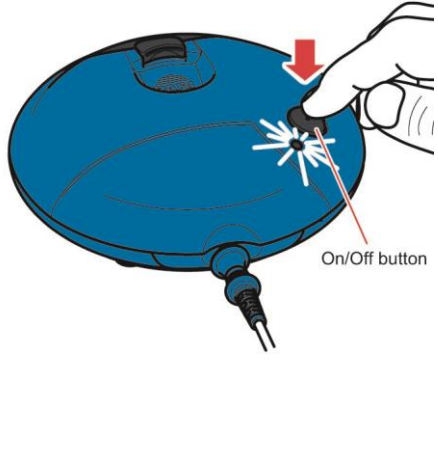

Step 6: Press the On/Off button to turn on the Controller as shown.

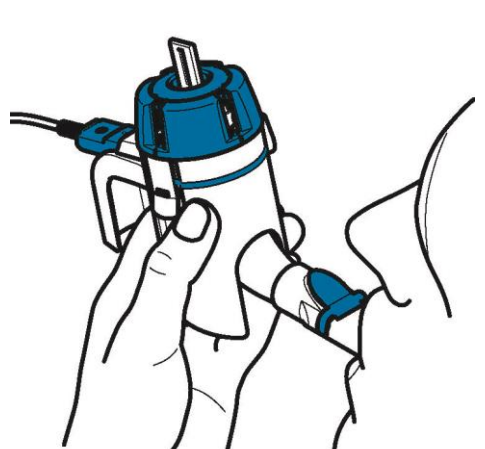

Step 7: Breathe in (inhale) and breathe out (exhale) normally through the Mouthpiece.



At the end of your treatment, you will hear a beeping sound and the Controller will automatically shut off. Your treatment should take about 2 to 3 minutes.

Cleaning the Handset

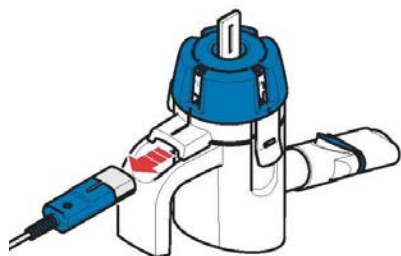

Step 1: Disconnect the Handset from the Connection cord.

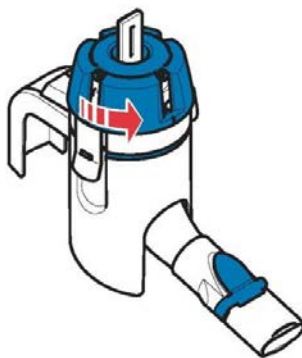

Step 2: Turn the Medication cap in a counter clockwise direction as shown, to remove it from the Handset body.

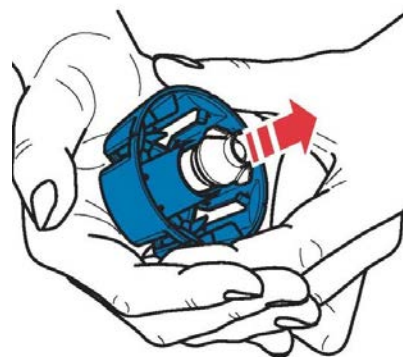

Step 3: Place the top of the Medication cap into the palm of your hand and push up as shown to remove the LONHALA vial. Throw away the LONHALA vial into the wastebasket.

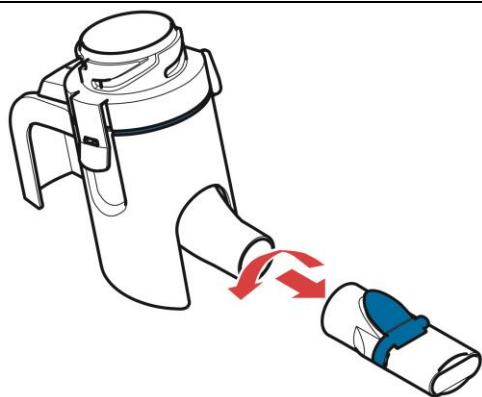

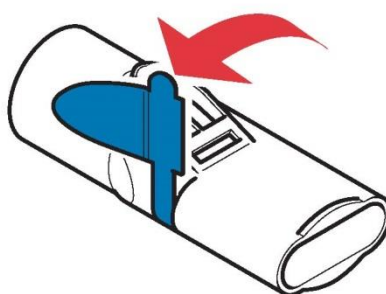

Step 4: Remove the Mouthpiece from the Handset body by giving it a gentle twist and pull to separate from the Handset body.

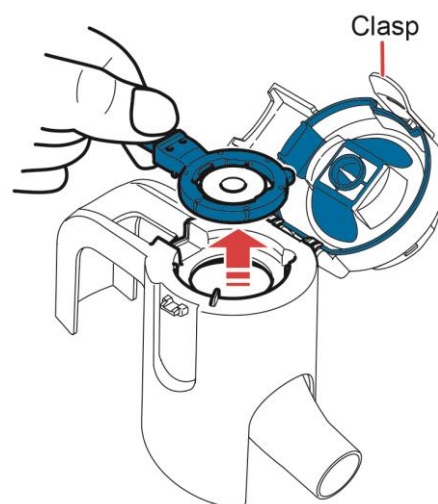

Step 5: Carefully loosen the blue valve from the slot in the Mouthpiece. Make sure the valve is still attached on one side to the Mouthpiece.

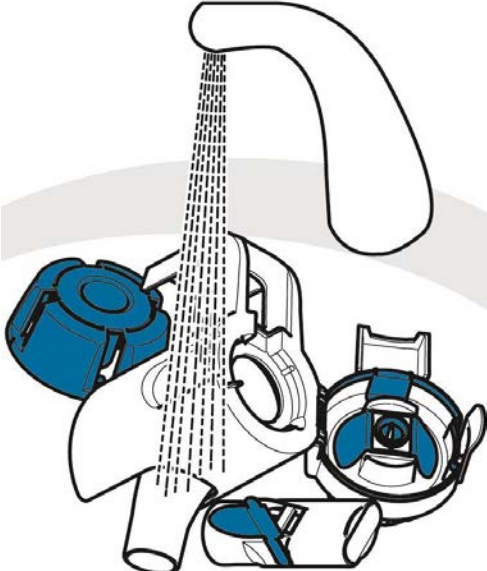
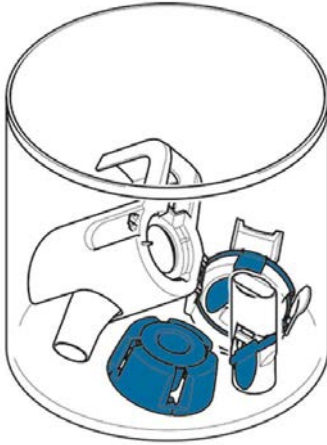
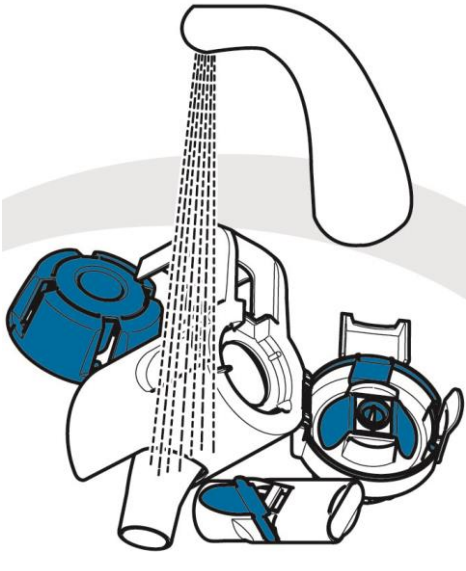
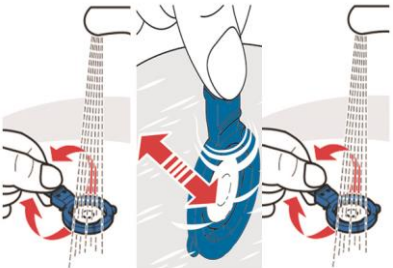

Step 6: Remove the Aerosol head from the Handset body by lifting the clasp on the side of the Handset body as shown. **Do not** touch the center of the Aerosol head.

		
<p>Step 7: Set aside the Aerosol head to be cleaned separately (see Step 10). Rinse all Handset parts well with warm running water for about 10 seconds.</p>	<p>Step 8: Wash all Handset parts in warm soapy water (water and clear liquid dishwashing soap) for about 10 seconds.</p>	<p>Step 9: Rinse the Handset parts well with warm running water for about 10 seconds to remove all of the soap.</p>
 <p>10A 10B 10C</p>		
<p>Step 10: Clean the Aerosol head using the instructions in Steps 7-9.</p> <p>10A. Rinse each side of the Aerosol head well with warm running water for about 10 seconds.</p> <p>10B. Hold the Aerosol head by the handle and swish it back and forth in the warm soapy water for about 10 seconds.</p> <p>10C. Then, rinse both sides of the Aerosol head well with warm running water for about 10 seconds on each side.</p> <p>Rinsing the Aerosol head well helps prevent clogging and ensure proper operation.</p>	<p>Step 11: Inspect all Handset parts to make sure they are completely clean. If any Handset parts are still dirty, soak the parts in warm soapy water for 5 more minutes. Rinse well with warm running water until the Handset parts are clean. Shake Handset parts to remove excess water. Air-dry all Handset parts on a lint-free towel.</p> <p>Do not put the Handset parts back together until ready to use again for your next treatment of LONHALA.</p>	<p>Step 12: Store the Handset parts in the carrying bag provided.</p>

Warnings and Precautions:

Failure to follow the Warnings and Precautions below could cause serious injury or may lead to death in some cases:

- Check all parts of your LONHALA MAGNAIR to make sure that they are clean and not damaged.
- Clean the Handset before the first use and after every use. If you do not clean the Handset after every use, your treatment could take more than 3 minutes.
- **Do not** leave the Aerosol head in your Handset.
- **Do not** wash the Controller, Connection cord, or AC adapter.
- Only use **clear liquid dishwashing soap** to wash the Handset parts. **Do not** use any other type of soap.
 - **Do not** use antibacterial soap. Antibacterial soap can damage the Aerosol head.
- **Do not** use a microwave oven to dry any parts of your LONHALA MAGNAIR.
- Allow all parts of your LONHALA MAGNAIR to air dry completely.

If you have any questions, contact Sunovion Customer Service at 1-888-394-7377.

This Instructions for Use has been approved by the U.S. Food and Drug Administration.

LONHALA and  are trademarks of Sunovion Pharmaceuticals Inc. MAGNAIR is a trademark of PARI Pharma GmbH, used under license.

SUNOVION and  are registered trademarks of Sumitomo Dainippon Pharma Co., Ltd. Sunovion Pharmaceuticals Inc. is a U.S. subsidiary of Sumitomo Dainippon Pharma Co., Ltd.

PARI and  are registered trademarks of PARI GmbH.
eFlow is a registered trademark of PARI Pharma GmbH.
Made under license of The Technology Partnership plc.



Manufactured for:
Sunovion Respiratory Development Inc.,
a wholly-owned subsidiary of Sunovion Pharmaceuticals Inc.
Made in Germany.

©2017 Sunovion Pharmaceuticals Inc. All rights reserved.

Issued: December 2017

902010R00



Lonhala[™] Magnair[™]
(glycopyrrolate) Inhalation Solution

MAGNAIR[™] NEBULIZER SYSTEM INSTRUCTIONS FOR USE

For use with LONHALA[™] (glycopyrrolate) Inhalation Solution only



Assembly required. LONHALA vials packaged separately.



Warning

Read and understand these **Instructions for Use** and all safety precautions it contains. Improper use can cause serious or fatal injury/illness.



Warning

Read and understand the full Patient Information (PI) for information and warnings related to LONHALA. The PI is contained in the LONHALA box.

TABLE OF CONTENTS

A. Safety Precautions..... 3
B. Getting Started..... 5
C. Steps for Using Batteries or AC Adapter with MAGNAIR..... 6
D. Assembling Your MAGNAIR 8
E. Using LONHALA MAGNAIR 11
F. Cleaning the Handset 15
G. Troubleshooting 20
H. 23

Intended Use and Authorized Users

MAGNAIR is intended for single-patient use in the delivery of LONHALA to patients who self-administer treatments or have treatments administered by a caregiver or health care provider.

MAGNAIR Handset is not sterile.

A. SAFETY PRECAUTIONS

These Instructions for Use contain information and safety precautions for MAGNAIR™ (MAGG-nair) Nebulizer System for use with LONHALA™ (lon-HAL-luh) (glycopyrrolate) Inhalation Solution.



Warning

MAGNAIR is designed for use only with LONHALA. To reduce the risk of severe or fatal injury/illness, **Never** use other medications in MAGNAIR. Read and follow all warnings and instructions in the Instructions for Use prior to using this device.

Save these **Instructions for Use** for future reference.

If for any reason you do not understand any part of these Instructions for Use, please contact the Sunovion Customer Service line 1-888-394-7377 before proceeding with your treatment.

Take special note of all safety precautions marked **Danger** and **Warning**.

IMPORTANT INFORMATION FOR USE

- US Federal law restricts this device to sale by or on order of a physician.

Read all Dangers and Warnings before using.



Dangers

To reduce the risk of serious or fatal injury from electrocution:

1. **Do Not** place or store MAGNAIR where it can be in water or fall into water (e.g., near a bathtub or sink). **Do Not** place or drop into water or other liquid. **Do Not** use while bathing.
2. **Do Not** reach for MAGNAIR if it has fallen into water or other liquid. If using AC adapter, unplug. Retrieve MAGNAIR only after it has been unplugged.



Warnings

1. The MAGNAIR Handset is intended for **Single Patient Use Only**. **Do not share** your MAGNAIR with anyone else.
2. MAGNAIR is designed for use only with LONHALA. To reduce the risk of severe or fatal injury/illness, **Never** use other medications in MAGNAIR.
3. Read and follow all warnings and instructions in the Instructions for Use prior to using this device.
4. To reduce the risk of serious or fatal injury from electrocution, burns, and to reduce the risk of damage and malfunction of the unit:
 - a. **Do Not** overload wall outlets or use extension cords.
 - b. Keep all electrical cords away from heated surfaces.
 - c. **Do Not** spray liquids onto the housing of the Controller. Liquid may cause damage to the electrical parts and could lead to a malfunction. In the event that liquids enter the Controller, contact the Sunovion Customer Service line (1-888-394-7377).
 - d. **Do Not** drop or insert any object into any opening on MAGNAIR.
 - e. **Do Not** operate where oxygen is being administered in a closed environment, such as an oxygen tent.



Warnings

5. Always unplug this product from AC power immediately after using and before cleaning.
6. Before use, check your Controller and Handset for proper assembly. All parts must be connected and in place. Use of an improperly assembled MAGNAIR could diminish or eliminate the effectiveness of the treatment.
7. **Use Only** adapters and accessories that are authorized for MAGNAIR. Use of unapproved adapters and accessories can lead to improper treatment, injury, or damage to the Controller.
8. **Never** operate the Controller if it is improperly or incompletely assembled or damaged. If you suspect either situation, call the Sunovion Customer Service line (1-888-394-7377).
9. **Never** operate MAGNAIR if:
 - a. it has damaged cords or plugs;
 - b. it is not working properly;
 - c. the inside of the Controller has been exposed to any liquids.
10. To maintain the of MAGNAIR, remove the Aerosol head from the MAGNAIR Handset body and clean and air-dry all MAGNAIR Handset parts after each treatment. Follow the instructions in **Section F** to clean the MAGNAIR Handset properly.
11. Cleaning the MAGNAIR Handset properly will help prevent the Aerosol head from clogging. If the Aerosol head becomes clogged, the aerosol mist may be reduced, altered, or stopped, which could increase the nebulization time (up to 15 minutes) and/or diminish the effectiveness of the treatment. **Do Not Stop Treatment** until MAGNAIR shuts off.
12. This product contains small parts that may present a choking hazard to small children. The MAGNAIR AC adapter and Connection cord also presents a strangulation hazard.
13. Close supervision is necessary when this product is used near children or the physically or mentally impaired.
14. **Do Not** allow pets near the Connection cord or AC adapter as they may chew on and damage them.
15. **Do Not** use your MAGNAIR while driving or in any situation that takes away your full attention.
16. **Do Not** disassemble the blue Controller at any time. There are no user serviceable parts inside the Controller. Contact the Sunovion Customer Service line (1-888-394-7377) for help.
17. **Do Not** use alcohol for cleaning and disinfection. Some parts will be damaged by alcohol.
18. The LONHALA vial is for single use only and must not be reused, or used in any other device.

B. GETTING STARTED

Check to make sure you have all of the following MAGNAIR parts and become familiar with how to identify each piece. If any parts are missing, call the Sunovion Customer Service line (1-888-394-7377). See Fig. B1.

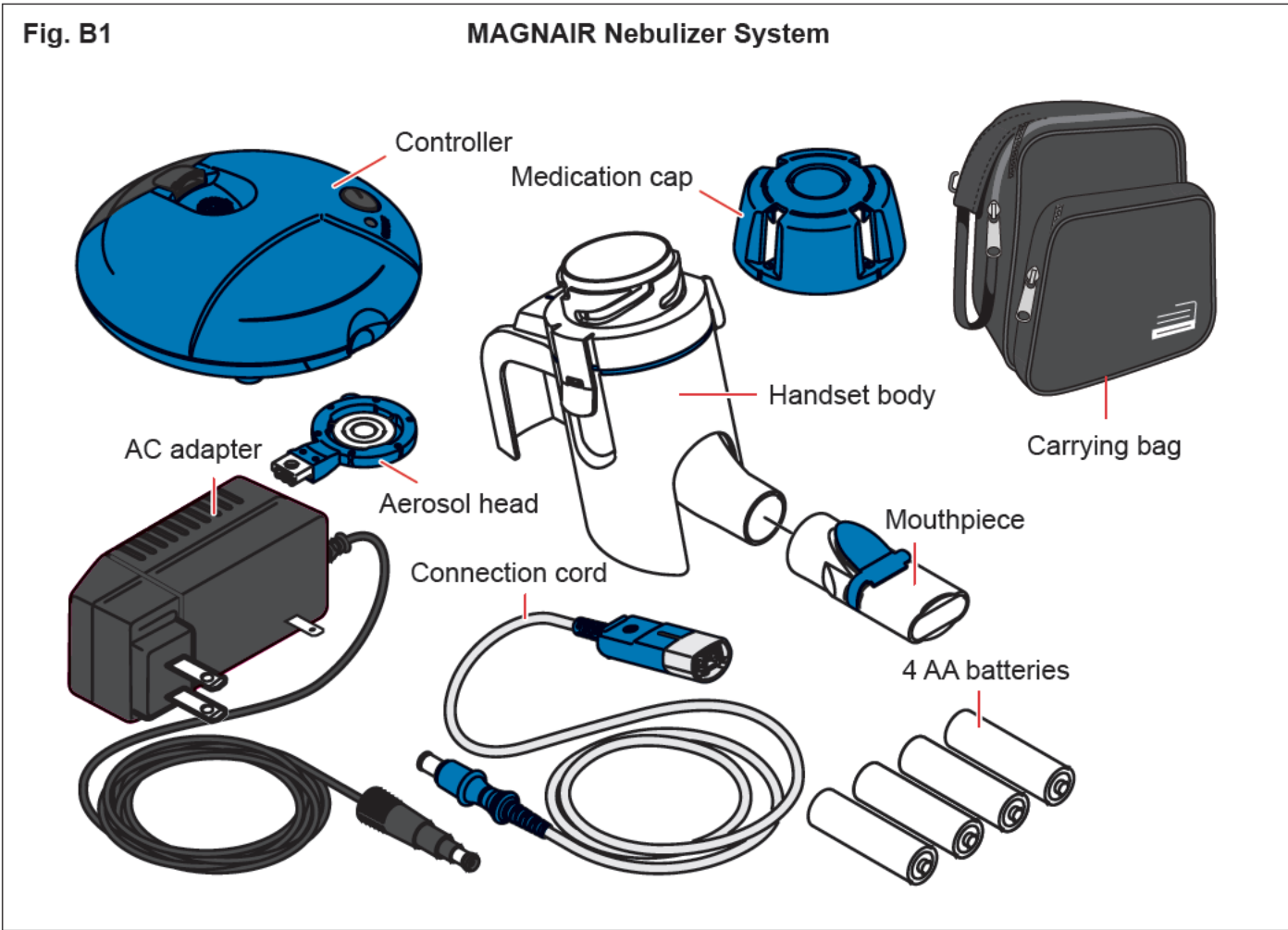

LONHALA vials packaged separately.

C. STEPS FOR USING BATTERIES OR AC ADAPTER WITH MAGNAIR

MAGNAIR is designed to be used with AA batteries or with the AC adapter.

STEPS FOR USING BATTERIES WITH MAGNAIR

Four (4) high quality AA batteries will provide approximately 2 weeks of treatment.

C1. Open the battery door on the Controller by placing your thumb on the black tab of the battery door and pushing the tab to open the door. Note that the battery door is designed to have a tight fit. See Fig. C1.

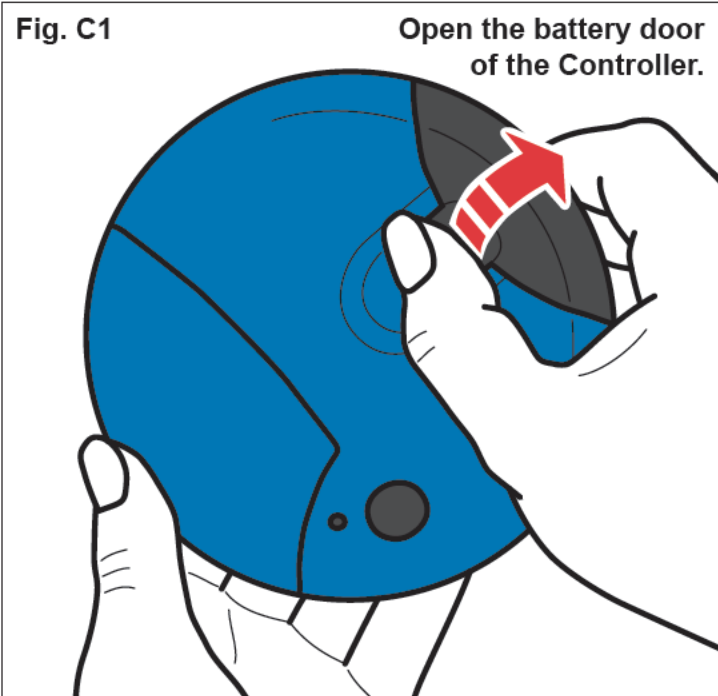

C2. Load the batteries. Each battery chamber has a small window that shows the proper position of each battery. Using the battery tips as guides and starting left-to-right, insert the batteries: tip out, tip in, tip out, tip in. See Fig. C2.

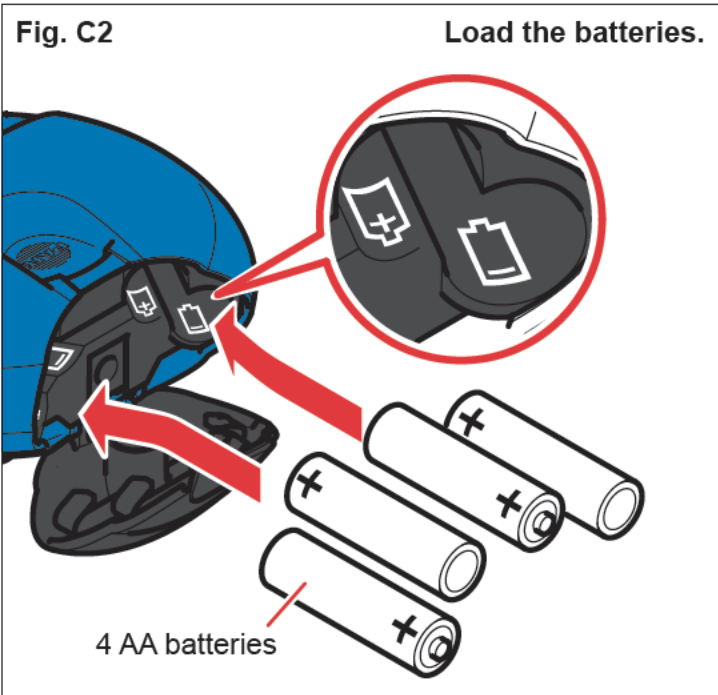

C. STEPS FOR USING BATTERIES OR AC ADAPTER WITH MAGNAIR (cont.)

Instructions for Use

C3. Close the battery door.

To close the battery door, push it closed until you hear it Click into place. See Fig. C3.

NOTE: Rechargeable and disposable batteries vary considerably in terms of storage life and output. If used exclusively, batteries have an operating life of ~2 weeks, based on high quality disposable AA batteries that meet the listed in **Section H** and following the cleaning procedure described in **Section F**. To reduce the risk of battery leakage, it is recommended to remove the batteries if you plan to store the Controller for more than 30 consecutive days.

If you choose not to use the AC adapter, it is strongly recommended to have an extra set of batteries with you at all times.

Fig. C3

Close the battery door of the Controller.



STEPS FOR USING THE AC ADAPTER WITH MAGNAIR

The AC adapter will automatically adjust to the incoming voltage. The AC adapter will power MAGNAIR with and without installed batteries.

C4. Plug the AC adapter into the Controller.

To connect the AC adapter to the Controller, place the Controller on a stable surface. The inlet is located on the underside of the black battery door. Push the round end of the AC adapter cord into the inlet. **Do Not** try to insert the AC adapter into the blue colored part of the Controller. See Fig. C4-C5.

C5. Plug the AC adapter into the wall outlet.

NOTE: the AC adapter will not charge the batteries in the Controller. See Fig. C4-C5.

Fig. C4-C5

Plug the AC adapter into the inlet on the black battery door of the Controller. Then plug the AC adapter into the wall outlet.

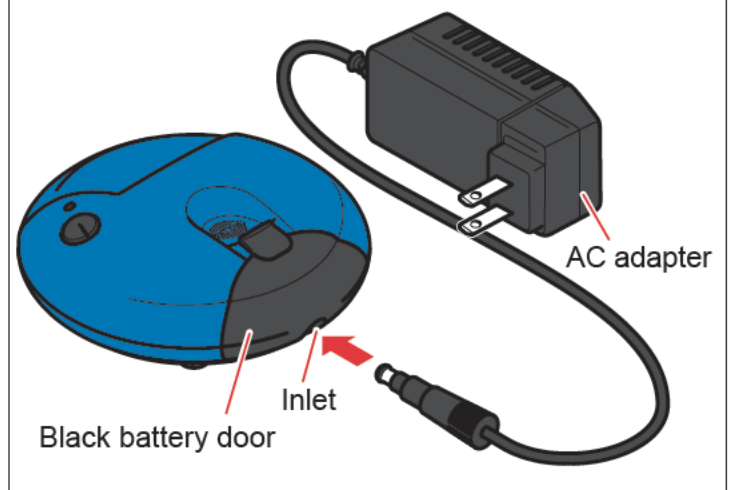

D. ASSEMBLING YOUR MAGNAIR

Your Handset parts (Medication cap, Aerosol head, Handset body, and Mouthpiece) will be replaced when you receive your next supply of LONHALA. Discard your old Handset parts and use the new Handset parts every time you get a LONHALA

Warning



and after every use. (See **Section F.**) Inspect all Handset parts to ensure they are clean and not damaged. **Do Not** leave the Aerosol head in the Handset body after use, and **Do Not** use dirty or damaged parts because this can impair the function of the Handset.

D1. Wash your hands.

D2. Open the top of the Handset body.

Lift the clasp on top of the Handset body slightly and flip it up to open.

See Fig. D2.

D3. Insert the Aerosol head into the Handset body as shown, taking care **Not** to touch the center of the Aerosol head. Hold the Aerosol head like you would hold a small frying pan so that the silver text side is facing up and the brown ring is facing down. Notice that the Aerosol head has a small tab on the side. Align the small tab with the matching notch in the Handset body.

See Fig. D3.

Fig. D2 Open the Handset body.

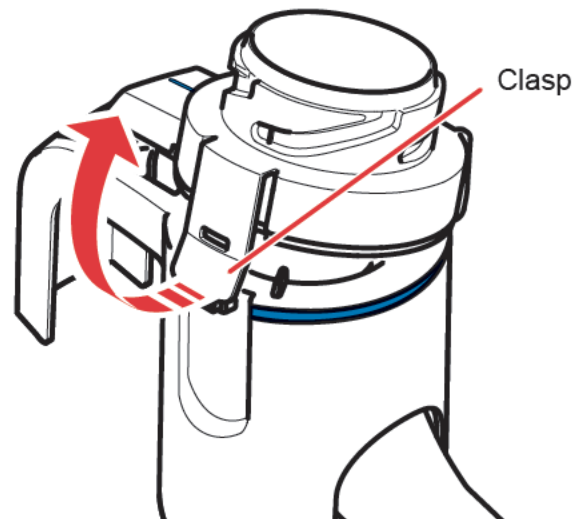
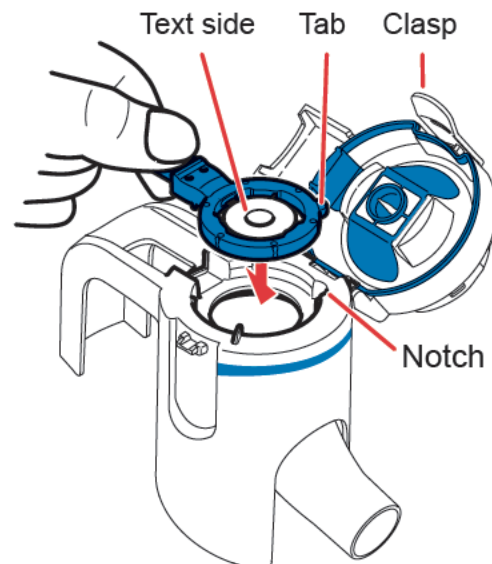

Fig. D3 Insert the Aerosol head into the Handset body. Do not touch the center of the Aerosol head.



D4. Close the Handset body, making sure the Aerosol head is properly inserted and the tab is aligned with the notch and level with the Handset body. You may hear a Click. If you do not close your Handset body completely or align the Aerosol head correctly, your medication may leak and you will not get your full treatment. See Fig. D4.

Do not force the top of the Handset body closed. If the top of the Handset body cannot close (no Click is heard), make sure that the Aerosol head is seated correctly and level.

Fig. D4

Close the Handset body.

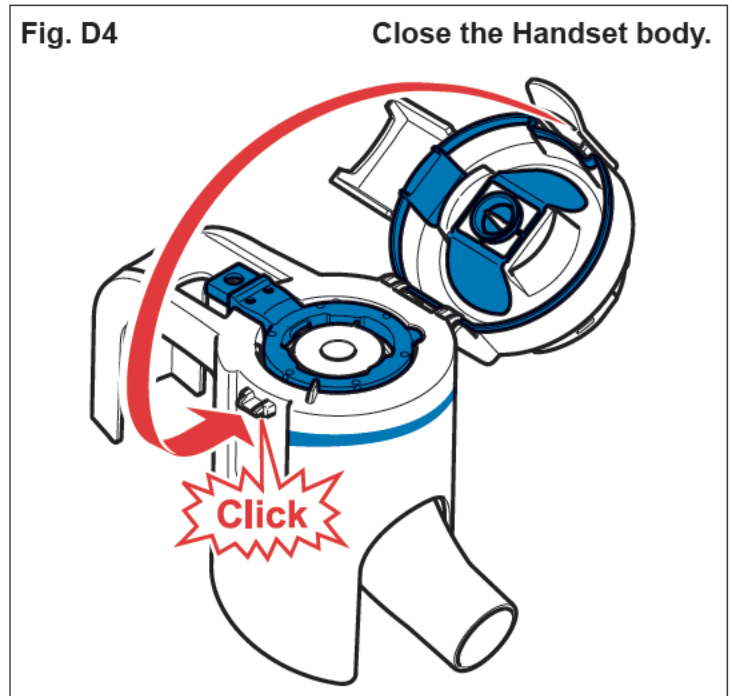

D5. Attach the Mouthpiece to the Handset body. Make sure the Blue valve is pressed down into the slot on the Mouthpiece and is positioned on the top of the Mouthpiece before attaching the Mouthpiece onto the Handset body. See Fig. D5.

Fig. D5

Attach the Mouthpiece.

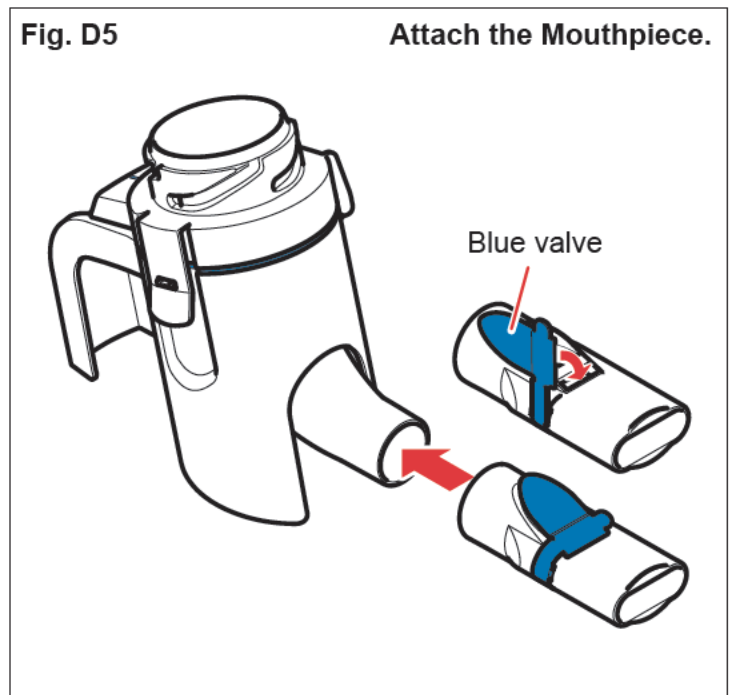

D6a. Connect the Controller to the Handset body using the Connection cord.

- One end of the Connection cord has a blue round connector. Insert the Connection cord into the inlet on the blue side of the Controller. Push the Connection cord in as far as it will go. You will hear a slight Click if inserted correctly. See Fig. D6a.

Fig. D6a

Connect the Connection cord to the Controller.

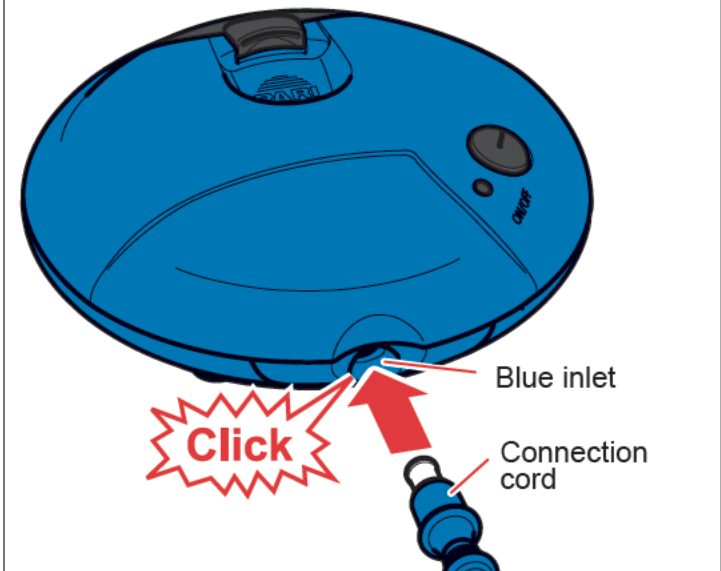

D6b. Connect the Controller to the Handset body using the Connection cord as shown.

- The other end of the Connection cord is blue and gray. Insert the Connector (with gray mark facing up) into the Handset body as far as it will go, ensuring the gray mark on the Connection cord lines up with the blue mark on the Handset body.
- Check that the ends of the Connection cord are fully inserted into the Controller and the Handset body. If they are not, the Handset may not work properly. See Fig. D6b.

Fig. D6b

Connect the other end of the Connection cord to the Handset body.

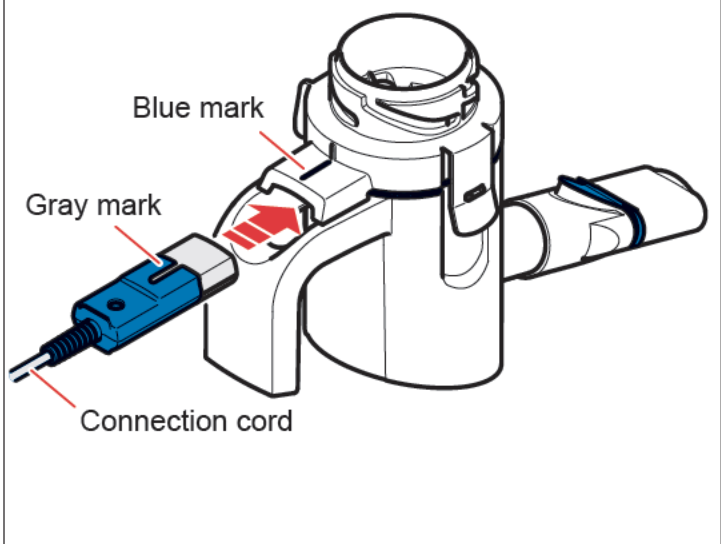

E. USING LONHALA MAGNAIR

E1. With clean hands, open the foil pouch enough to remove the 2 LONHALA vials.
Manually separate by twisting apart the 2 LONHALA vials and return 1 vial back to the opened foil pouch and store in the Carrying bag to be used at the next treatment. Discard the vial if not used within 7 days. See Fig. E1.

 **Warning**
MAGNAIR will only operate with vials containing LONHALA. Do not try to use any other type of medication with your MAGNAIR or use the vials in any other type of device.

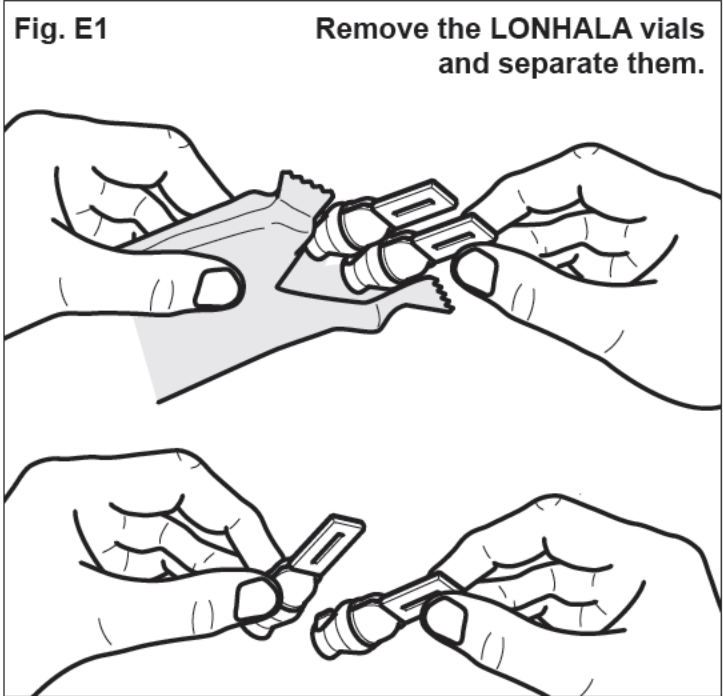

E2. Insert 1 LONHALA vial into the Medication cap.
The Medication cap has a top and a bottom. Insert a LONHALA vial with the tab through the bottom of the Medication cap and press it in as far as it will go. You should hear a Click if the LONHALA vial was inserted correctly. See Fig. E2.

You should be able to hear a Click when the LONHALA vial is inserted correctly.

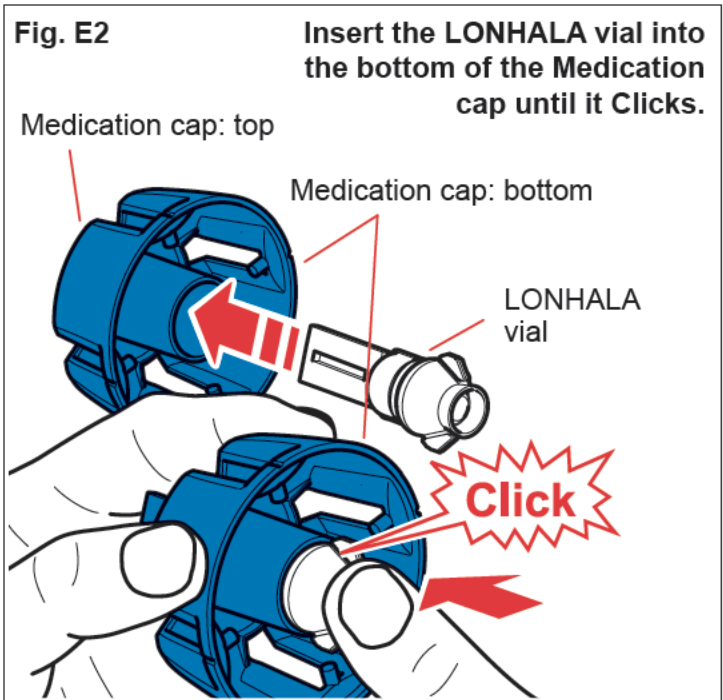

E3. Prepare to attach the Medication cap.
Do Not touch the part of the Handset body that pierces the LONHALA vial.
See Fig E3a.

Make sure the Aerosol head is installed before attaching the Medication cap because your medicine could leak and you will not get your full treatment.

Place the Medication cap with the LONHALA vial on top of the Handset body.
See Fig. E3b.

Turn the Medication cap in a clockwise direction. As you turn the Medication cap, the LONHALA vial will open and you should hear a Click. The notch (at the base of the opening) in the Medication cap should line up with the blue line on the Handset body.
See Fig. E3c.

Fig. E3a

Do not touch the part that pierces the vial.

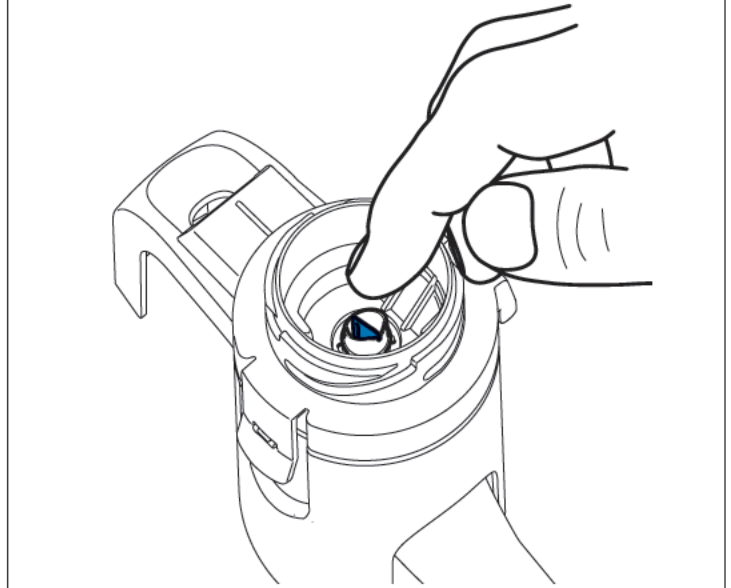

Fig. E3b

Place the Medication cap with LONHALA vial on top of the Handset body.

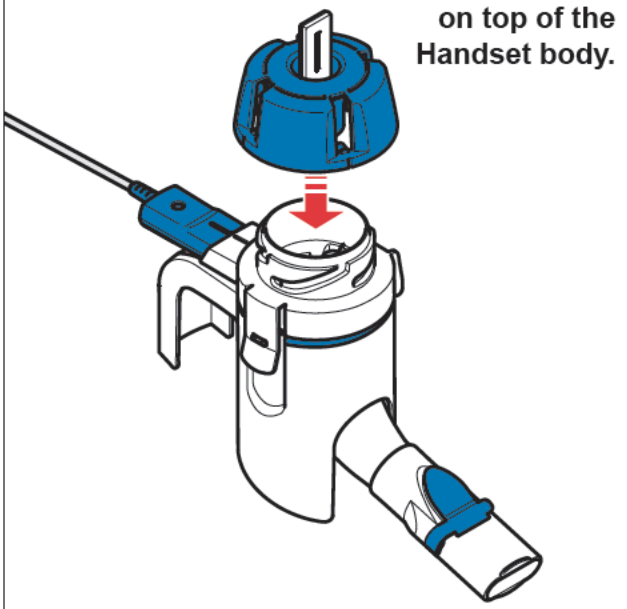
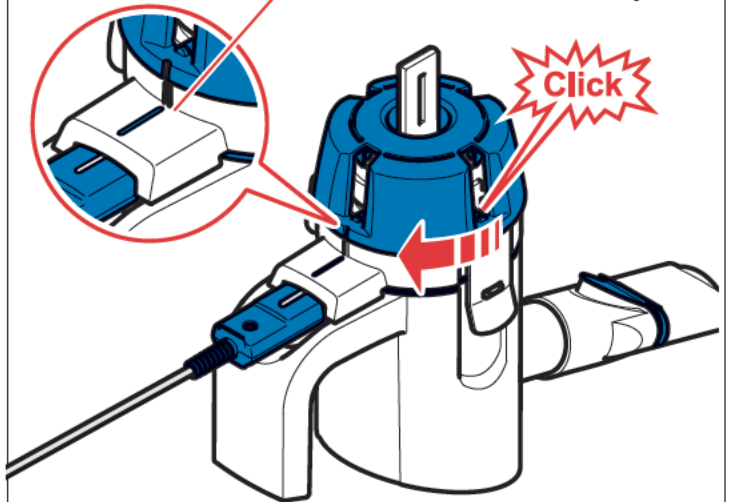

Fig. E3c

Turn the Medication cap onto the Handset body until you hear a Click.

Line up notch in cap with blue line on Handset body.



Warning

Do Not Loosen or remove the Medication cap or unclasp the Handset until treatment is completed because your medicine could leak and you will not get your full treatment.

E4. Insert the Mouthpiece into your mouth.

- Sit in an upright position and relax. This makes inhaling easier.
- Hold the Handset body with your hand then place the Mouthpiece into your mouth and seal your lips around it.
- **Do Not** tilt the Handset. Make sure the Handset is level.
- **Do Not** cover the blue valve with your lips.
- **Do Not** Loosen or remove the Medication cap until your treatment is complete because your medication could leak and you will not get your full treatment. See Fig. E4.

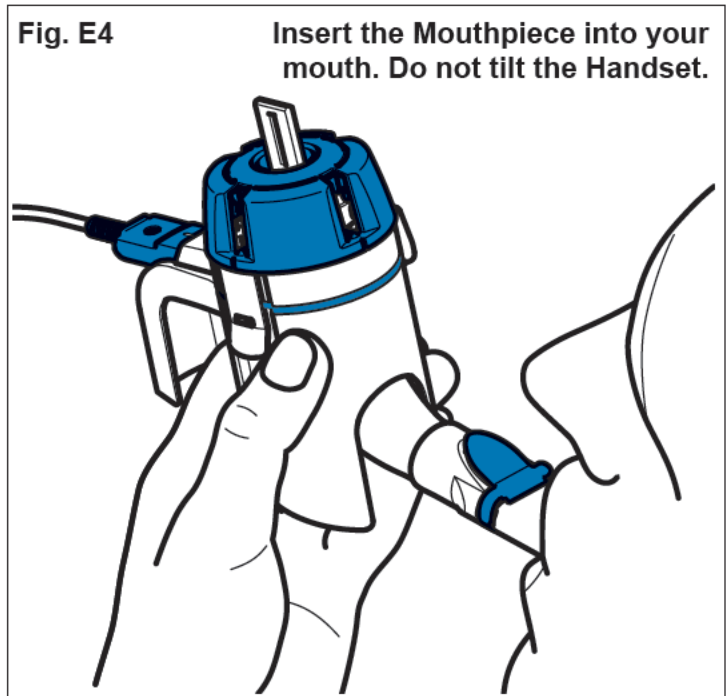

E5. Turn on the Controller.

- Press the On/Off button to start your treatment.
- A green LED light beside the On/Off button will light up and a single **Beep** will be heard to indicate proper functioning. See Fig. E5.

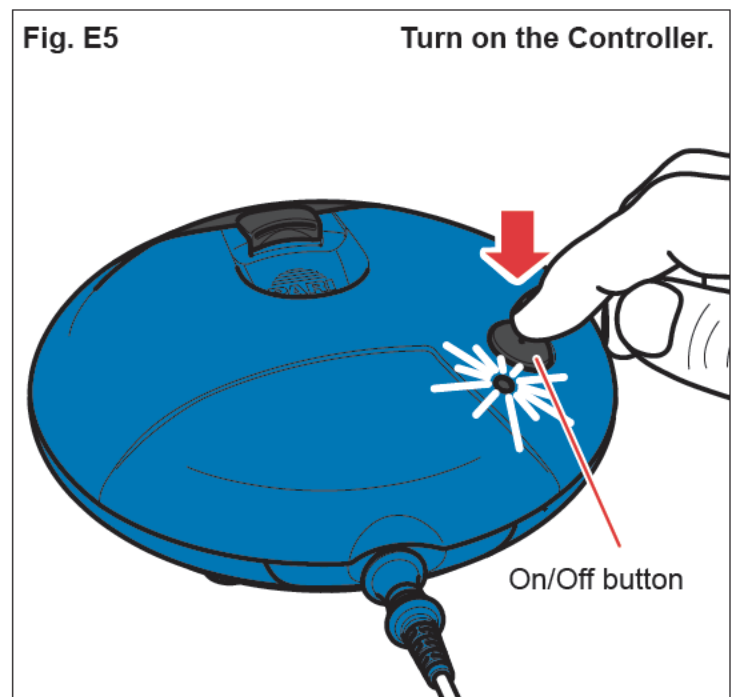

E6. Breathe in (inhale) and breathe out (exhale) normally through the Mouthpiece. The Mouthpiece should remain in your mouth throughout the treatment period. **Do Not breathe through your nose.** While you are exhaling, you may see the blue lift and some mist escape. See Fig. E6.

- Continue inhaling and exhaling through the Mouthpiece until the Controller Beeps and shuts off.
- **To pause your treatment, press the On/Off button.** To continue your treatment, press the On/Off button again. See Fig. E5.

Fig. E6

Inhale and exhale normally.

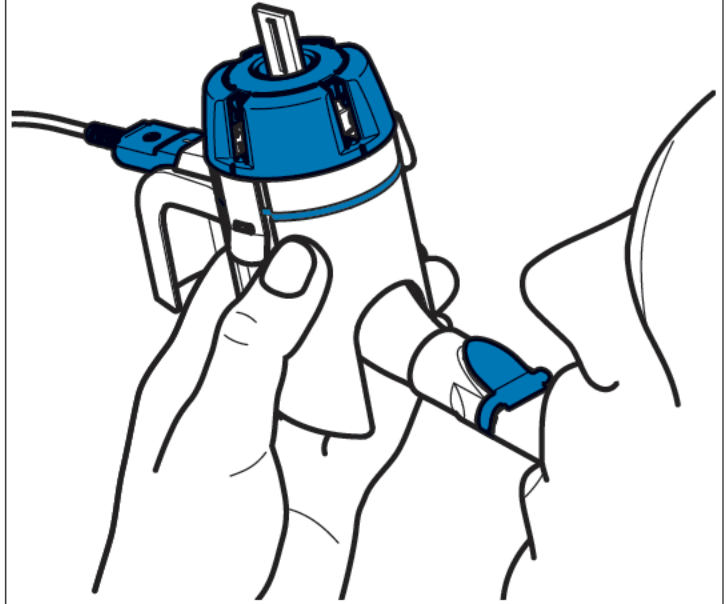

E7. At the end of treatment, the Controller will automatically shut off. When all of the medication has been delivered, you will hear 2 Beeps, the green LED light will turn off, and the Controller will automatically shut off. Your treatment should take 2 to 3 minutes. See Fig. E7.

Fig. E7

Your treatment should take about 2 to 3 minutes.



Warning

If you do not clean the Handset parts after every use, your treatment time might take more than 3 minutes. If the treatment is taking longer than 3 minutes, continue with your treatment until the Controller shuts off to make sure that you get your full treatment.

F. CLEANING THE HANDSET



Warning

To ensure proper operation and to reduce the risk of severe or fatal injury/illness.

Important: Rinse and clean the MAGNAIR Handset parts after every use. Use clear liquid dishwashing soap. Do Not use white dishwashing soap (e.g., Ivory or Dove) or antibacterial liquid dish soaps, as these may contain additives harmful to the Aerosol head. **Do Not** leave the Aerosol head in your Handset. **Do Not** wash the Controller, Connection cord, or AC adapter.



Caution

- **Do Not** put MAGNAIR parts into a microwave oven.
- **Do Not** clean the MAGNAIR parts in a dishwasher.
- **Do Not** clean the Aerosol head and Handset parts with brushes or abrasives.

CLEANING THE HANDSET

F1. Disconnect the Handset from the Connection cord. See Fig. F1.

F2. Turn the Medication cap in a counterclockwise direction as shown, to remove from the Handset body. See Fig. F2.

Fig. F1

Disconnect the Handset.

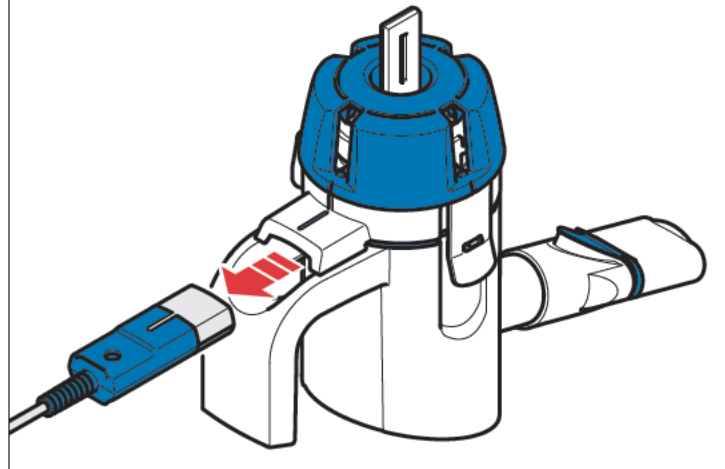
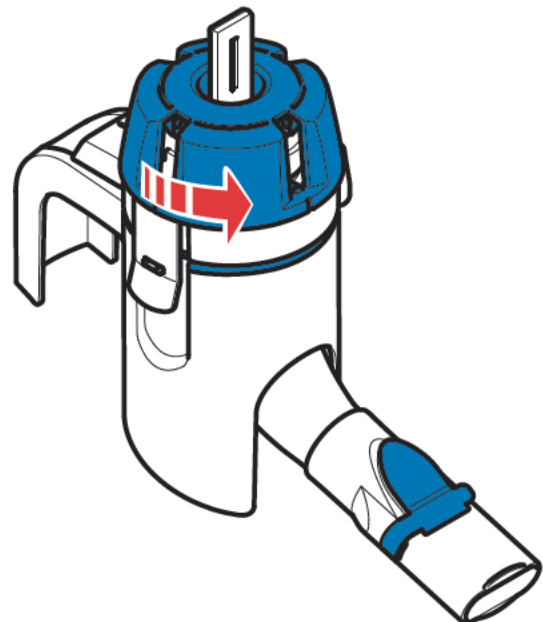

Fig. F2

Remove the Medication cap.



F3. Remove the LONHALA vial.

Place the top of the Medication cap into the palm of your hand and push up as shown to remove the LONHALA vial. Throw away the LONHALA vial into wastebasket. See Fig. F3.

Fig. F3

Remove the LONHALA vial.

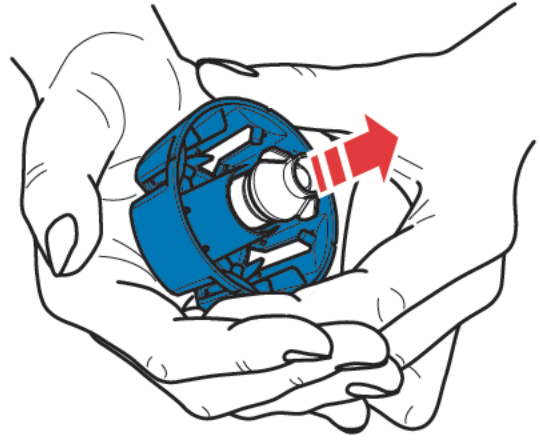

F4. Remove the Mouthpiece from the Handset body by giving it a gentle twist and pull to separate from the Handset body. See Fig. F4.

Fig. F4

Remove the Mouthpiece.

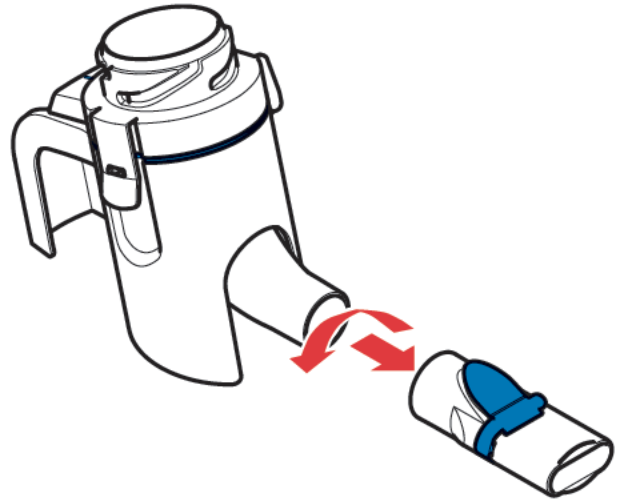

F5. Loosen the blue valve. Carefully loosen the blue valve from the slot in the Mouthpiece. Make sure the valve is still attached on one side to the Mouthpiece. See Fig. F5.

Fig. F5

Loosen the blue valve.

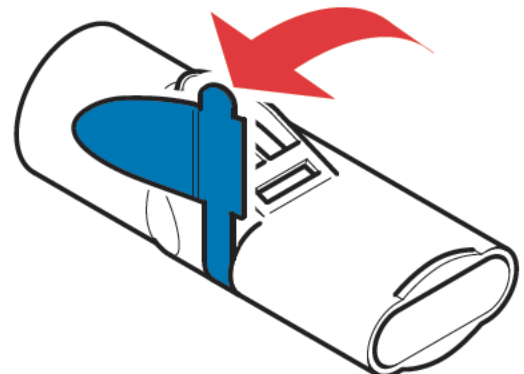

F. CLEANING THE HANDSET (cont.)

Instructions for Use

F6. Remove the Aerosol head from the Handset body by lifting the clasp on the side of the Handset. Then remove the Aerosol head by lifting the handle.

Do Not touch the center of the Aerosol head.
See Fig. F6.

Set aside the Aerosol head to be cleaned separately in Step F10.

F7. Rinse each of the disassembled Handset parts well under warm (above 105°F) running tap water. (approx. 10 seconds). See Fig. F7.

F8. Wash all Handset parts in warm (above 105°F), soapy water made by adding a few drops (~¼ teaspoon) of clear liquid dishwashing soap into a bowl (~1 quart) of clean warm tap water. Swish the Handset parts around in the soapy water to clean. See Fig. F8.

- **Do Not** wash the Connection cord, Controller, and AC adapter.
- **Do Not** use white dish soap or antibacterial hand soaps because they may clog the Aerosol head.
- **Do Not** use a brush or abrasive to clean any of the Handset parts because it may damage them.

Fig. F6 Remove the Aerosol head from the Handset body. Do not touch the center of the Aerosol head.

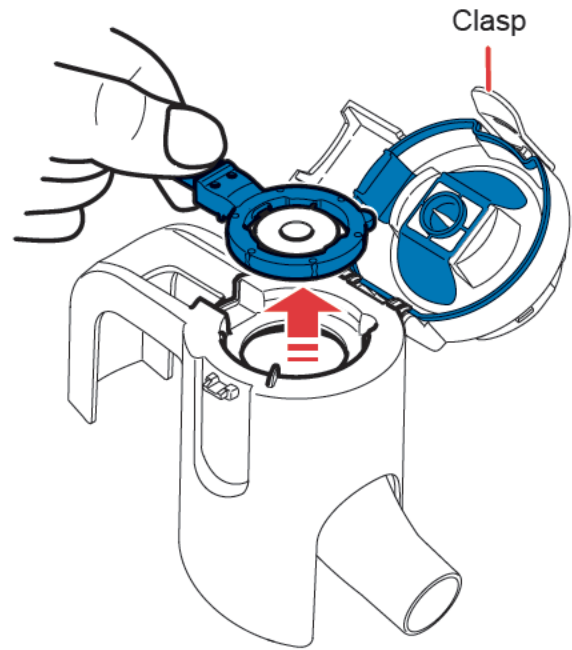

Fig. F8 Wash all Handset parts in warm soapy water for about 10 seconds.

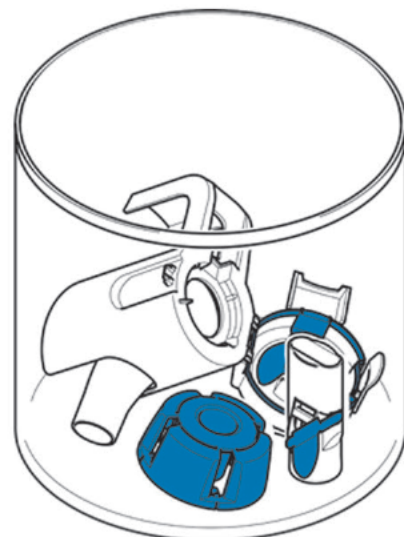
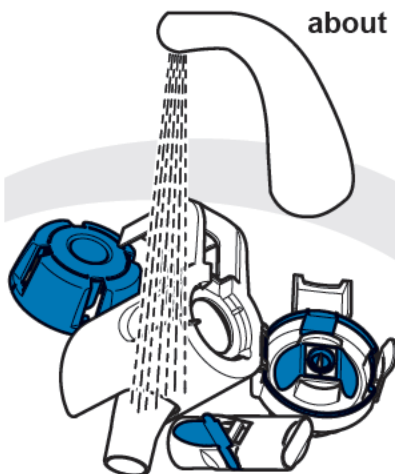

Fig. F7 Rinse all Handset parts with warm running water for about 10 seconds.



F9. Rinse the Handset parts well under running warm tap water (approximately 10 seconds). See Fig. F9.

F10. Clean the Aerosol head following the instructions in Steps 7 through 10.

10A. Rinse both sides of the Aerosol head well with warm running water for about 10 seconds on each side.

10B. Wash the Aerosol head by holding the handle and swishing it back and forth in the warm soapy water for about 10 seconds.

10C. Rinse both sides of the Aerosol head well with warm running water for about 10 seconds on each side.

Rinsing the Aerosol head well helps prevent clogging and ensures proper operation.

Fig. F9

Rinse Handset parts well with warm running water for about 10 seconds.

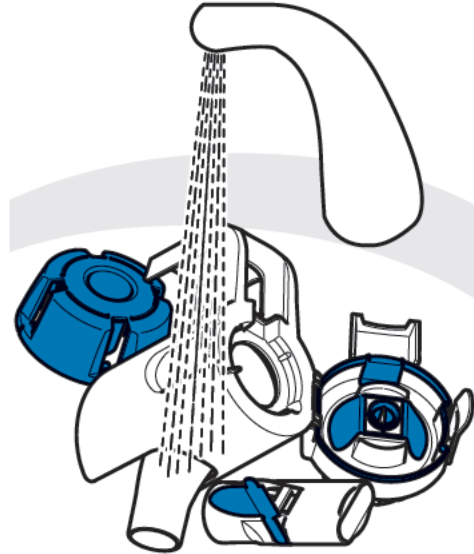

Fig. 10A

Rinse Aerosol head with warm running water for about 10 seconds.

Fig. 10B

Wash Aerosol head in warm soapy water for about 10 seconds.

Fig. 10C

Rinse Aerosol head with warm running water for about 10 seconds.

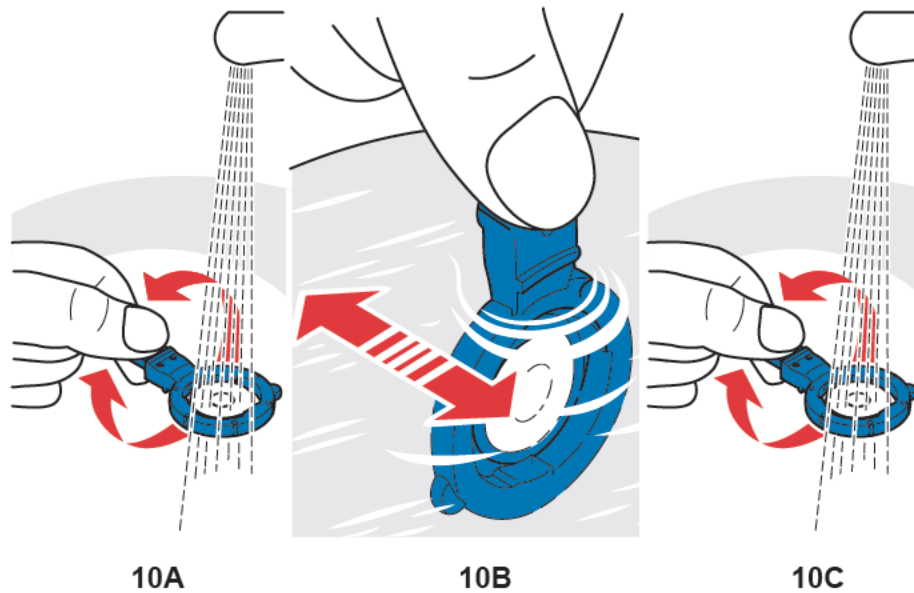

- **Do Not** add dishwashing liquid directly onto the Aerosol head, add to water only.
- **Do Not** use a brush or abrasive to clean the Aerosol head because it may damage it.

F11. Inspect all Handset parts to make sure they are completely clean. If any Handset parts are still dirty, soak the parts in warm soapy water for 5 more minutes. Rinse well with warm running water until clean.



Warning

Contamination and moisture may affect the Aerosol head and encourage the growth of bacteria. Therefore, it is important to remove the Aerosol head from the Handset body and clean the Handset parts after every use. If Handset parts are still dirty after cleaning, then soak and rinse as described in step F11.

F12. Air-dry all Handset parts.

Remove excess water by shaking all parts. Place all Handset parts on a dry, clean, lint-free towel and allow them to air-dry. **Do Not** dry using a paper towel. **Do Not** touch the center of the Aerosol head. See Fig. F12.

F13. Store disassembled Handset parts.

After the Handset parts are completely dry, place them in the provided Carrying bag or a dry, dust-free environment for storage. **Do Not** put the Handset parts back together until ready to use again for your next treatment of LONHALA.

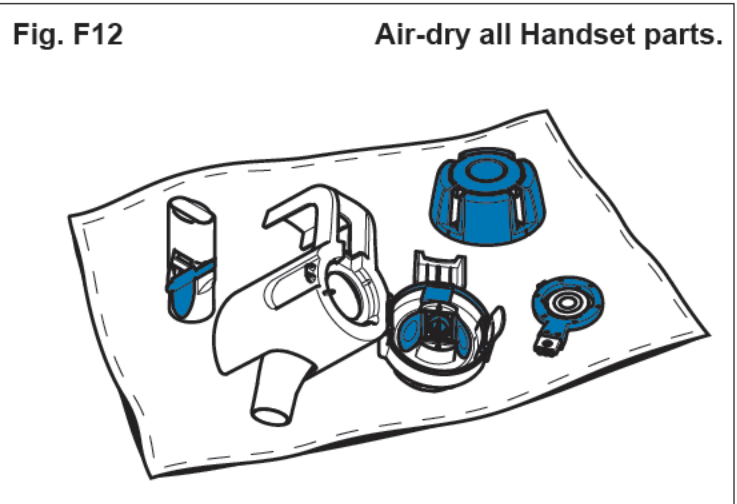

Warning

A damp environment encourages the growth of bacteria. Make sure all Handset parts are dried properly.

CARING FOR THE CONTROLLER, CONNECTION CORD AND AC ADAPTER

- Make sure the Controller is off. Remove the Connection cord and AC adapter cord from the Controller.
- Remove the AC adapter from the wall socket.
- Clean the Controller housing, the Connection cord, and AC adapter with a damp cloth.



Warning

- Never let the Controller come in contact with water and never use cleaning agents.
- If liquid does get into the Controller, contact the Sunovion Customer Service line (1-888-394-7377).

G. TROUBLESHOOTING

CONTROLLER FEEDBACK INDICATORS

	Controller AUDIBLE SIGNAL	Controller VISUAL SIGNAL	Conditions	Action Required
1	1 Brief Beep at start of dose.	Solid green LED for duration of dose.	Normal: generating aerosol mist, no errors detected.	No action required. MAGNAIR is on and working properly.
2	1 Brief Beep at start of dose.	Flashing orange-green LED.	Low battery power.	Replace batteries or use AC adapter.
3	1 Brief Beep at start of dose followed by a 2-tone Beep.	Green LED followed by orange-green and then shuts off.	No connection detected. Two Beeps occurred immediately after starting. No drug detected. Two-tone Beep occurred 10-30 seconds after starting.	Check connection between the Controller and the Handset. Check to ensure a LONHALA vial has been inserted and the Handset clasp is closed properly. Tilt the Handset from side to side then tap the Handset to dislodge LONHALA and restart the Controller.
4	1 Brief Beep.	LED starts green, then turns orange and shuts off.	Treatment interrupted. The Controller On/Off button has been intentionally or unintentionally pressed.	Press the Controller On/Off button to resume treatment.
5	2 Brief Beeps.	LED green for 2 seconds, and then shuts off.	Normal: end of dose.	No action required. LONHALA vial contents are empty.
6	2-tone Beep.	LED orange-green.	Maximum nebulization time reached (15 minutes). Aerosol head clogged.	Press On/Off to resume treatment if medication is still present. Clean the Aerosol head.

POTENTIAL FAULTS AND POSSIBLE CAUSES / RESOLUTIONS

Fault	Possible Causes / Resolutions
1	<p>MAGNAIR cannot be turned on – no green LED and no Beep.</p> <p>No power The batteries are discharged. Replace them or use the AC adapter.</p> <p>The batteries are not inserted correctly. Remove batteries and reinsert following diagram on the battery compartment.</p> <p>The AC adapter is not connected correctly. Check the wall connection and the Controller connection.</p>
2	<p>The LED orange-green, there is a 2-tone Beep and the Controller turns off.</p> <p>No connection between Handset and Controller Check the connection between the Controller and the Handset.</p>
3	<p>No aerosol mist appears when MAGNAIR is turned on, or MAGNAIR turns off after a few seconds.</p> <p>Low power Check for bad batteries.</p> <p>Missing or improper insertion/assembly of LONHALA vial that a new LONHALA vial has been inserted.</p> <p>Tap MAGNAIR slightly to move the liquid to the bottom of the LONHALA vial. If aerosol mist is still not generated after MAGNAIR has been restarted, the LONHALA vial may not have been pierced or is empty. Replace the vial if empty.</p> <p>If partial dose has been received, contact your health care provider for instructions.</p>
4	<p>The indicator light (LED) orange-green during operation.</p> <p>Low battery power Replace the batteries or use the AC power.</p>
5	<p>Mist appears but the Controller turns off prematurely.</p> <p>Low battery power Replace the batteries or use the AC power.</p> <p>The Handset was not being held upright Hold the Handset upright and press the On/Off button.</p> <p>If partial dose has been received and/or medication spills, call your health care provider.</p> <p>If Handset clasp is broken and/or does not close properly, call Sunovion Customer Service (1-888-394-7377).</p>

POTENTIAL FAULTS AND POSSIBLE CAUSES / RESOLUTIONS

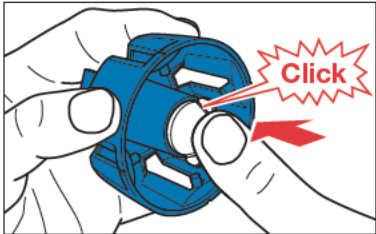
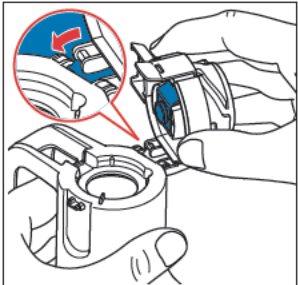
Fault		Possible Causes / Resolutions
6	MAGNAIR will not switch off automatically.	Turn MAGNAIR off by pressing the On/Off button.
7	Aerosol mist continuously escapes in large volumes from the opening slots in the Medication cap.	Improper Handset assembly. Check that the Handset has been assembled correctly and the Blue valve is pushed down.
8	The Medication cap will not close.	LONHALA vial is not seated properly. Press the LONHALA vial base toward the cap until you hear it snap into place. 
9	The LONHALA vial has been inserted incorrectly.	If the LONHALA vial has been inserted incorrectly, the following steps must be carried out: 1. Open the Medication cap. 2. If the LONHALA vial has been opened, throw away the LONHALA vial, rinse and dry the Handset parts, then insert a new vial. 3. If the LONHALA vial has not been opened, place the Medication cap back on the Handset and turn the Medication cap containing your LONHALA vial in a clockwise direction until it clicks, then restart your treatment by pressing the On/Off button.
10	Increasing or long inhalation time. ¹ Treatment time may vary up to 15 minutes if the Aerosol head has become clogged.	The Aerosol head may be clogged. Clean the Aerosol head by soaking it in soapy water for 5 minutes and rinse both sides well (Section F).
11	Top of Handset body has become detached from bottom of Handset body.	Line up the hinge part on the top of the Handset body with the hinge portion of the bottom of the Handset body. Press firmly until the parts snap together. You should hear a Click. 

¹ If the fault cannot be eliminated after following these steps, call the Sunovion Customer Service line (1-888-394-7377) immediately.

H. SPECIFICATIONS

ELECTRICAL

AC adapter	
Input	100 V-240 V, 50 Hz/60 Hz
Output	7.5 V
Batteries	
Disposable	4 x 1.5 V (high quality alkaline or photography-grade)
Rechargeable	4 x 1.2 V (Ni-Cd)

OPERATIONAL

Temperature	41° to 104°F (5° to 40°C)
Relative humidity (non-condensing)	15% to 93%
Air pressure	10 to 15 PSI (700 to 1060 hPa)
Aerosol output	0.85-1.15 mL
Aerosol output rate	0.4 mL/min

MECHANICAL

MAGNAIR Handset weight, without medication	approx. 2.6 oz (73 g)
MAGNAIR Controller weight (with batteries)	approx. 7.6 oz (220 g)
Nebulizer dimensions (W x H x D)	2.4 in. x 4.7 in. x 7.19 in. (6 x 12 x 18 cm)
Controller dimensions	H 1.6 in. (4 cm), Ø 4.6 in. (11.6 cm)

TRANSPORT / STORAGE

Temperature	-13° to 158° F (-25 to +70°C)
Relative humidity (non-condensing)	0 to 93%
Air pressure	7 to 15 PSI (500 to 1060 hPa)

HANDSET MATERIALS

Polypropylene, polyoxymethylene, polyamide, silicone, stainless steel, thermoplastic elastomers.
 Does not contain any natural rubber (latex).

DISPOSAL

The MAGNAIR parts and batteries must be thrown away in accordance with local (state, county, or municipal) regulations.

PERFORMANCE CHARACTERISTICS

LONHALA (glycopyrrolate) Inhalation Solution, 25 mcg/mL	Mean ¹	²
Delivered dose by breath simulation (mcg)	14.20	11.11–17.29
Delivered dose by breath simulation (% Label Claim)	56.80	44.45–69.16
MMAD ³ (µm) by NGI ⁴	3.71	2.92–4.49
Coarse Particles (Dia. >5 µm) by NGI (mcg)	5.83	2.32–9.33
Coarse Particles (Dia. >5 µm) by NGI in % of Delivered Dose	27.72	11.20–44.24
Fine Particles (Dia. ≤5 µm) by NGI (mcg)	15.20	11.46–18.93
Fine Particles (Dia. ≤5 µm) by NGI in % of Delivered Dose	72.28	55.77–88.79
Extra-Fine Particles (Dia. <1 µm) by NGI (mcg)	0.11	0.03–0.20
Extra-Fine Particles (Dia. <1 µm) by NGI in % of Delivered Dose	0.55	0.15–0.94
GSD ⁵ by NGI	1.66	1.49–1.83

¹ n=15 devices from 3 device lots; 5 devices tested per drug product batch x 3 batches drug product

² 95% Range: Two-sided tolerance interval, Proportion of total population=0.95,
 (1- Alpha)=0.95

³ MMAD: Mass Median Aerodynamic Diameter

⁴ NGI: Next Generation Impactor

⁵ GSD: Geometric Standard Deviation

Patented. See www.pari.com/ip.

Manufactured by:
PARI Respiratory Equipment, Inc., 2412 PARI Way, Midlothian, VA 23112

LONHALA and  are trademarks of Sunovion Pharmaceuticals Inc. MAGNAIR is a trademark of PARI Pharma GmbH, used under license.

SUNOVION and  are registered trademarks of Sumitomo Dainippon Pharma Co., Ltd. Sunovion Pharmaceuticals Inc. is a U.S. subsidiary of Sumitomo Dainippon Pharma Co., Ltd.



PARI and  are registered trademarks of PARI GmbH.

eFlow is a registered trademark of PARI Pharma GmbH.
Made under license from The Technology Partnership plc.



©2017 Sunovion Pharmaceuticals Inc. All rights reserved.

For Sunovion customer service, call 1-888-394-7377.

578D2000 Rev B 12/2017
902011R01

Reference ID: 4190417



Before using the MAGNAIR™ Nebulizer System, please read the full manufacturer's Instructions for Use, available in the MAGNAIR box and at www.LonhalaMagnair.com.

DEVICE parts:

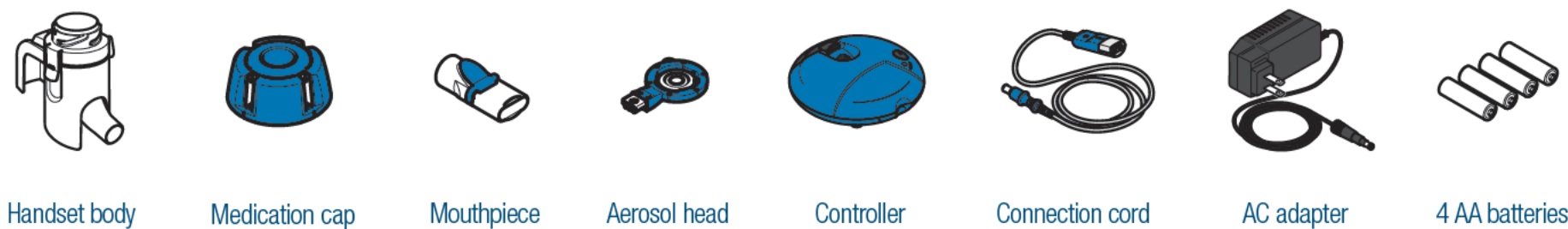

Before you use LONHALA™ MAGNAIR™ for the first time, it is important to clean all the parts. Replacement parts for the Handset (Handset body, Medication cap, Aerosol head, and Mouthpiece) will be provided with every LONHALA MAGNAIR Refill Kit. Please discard the old Handset parts when you receive the Refill Kit.

PRODUCT:



STORAGE:



Assembly and use

1 Power the Controller.

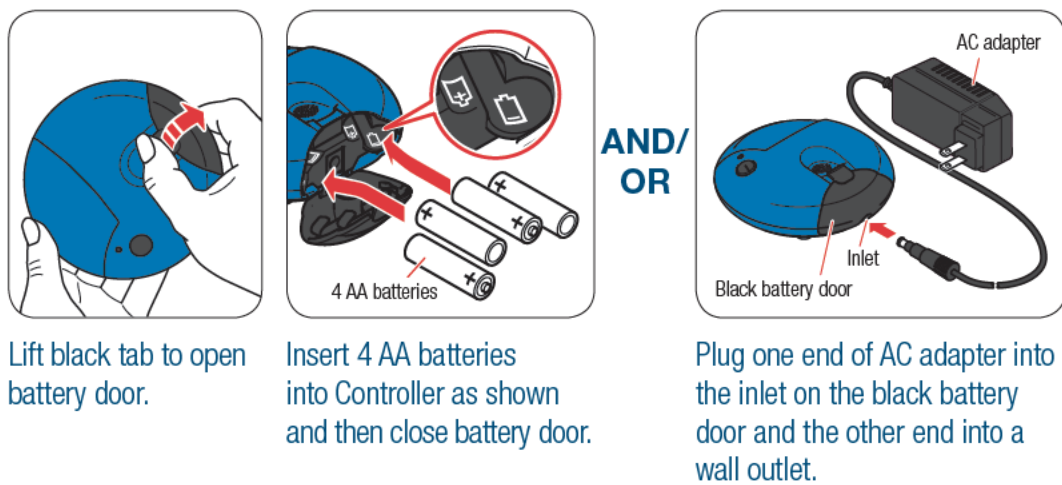

Lift black tab to open battery door. Insert 4 AA batteries into Controller as shown and then close battery door. Plug one end of AC adapter into the inlet on the black battery door and the other end into a wall outlet.

2 Insert Aerosol head.

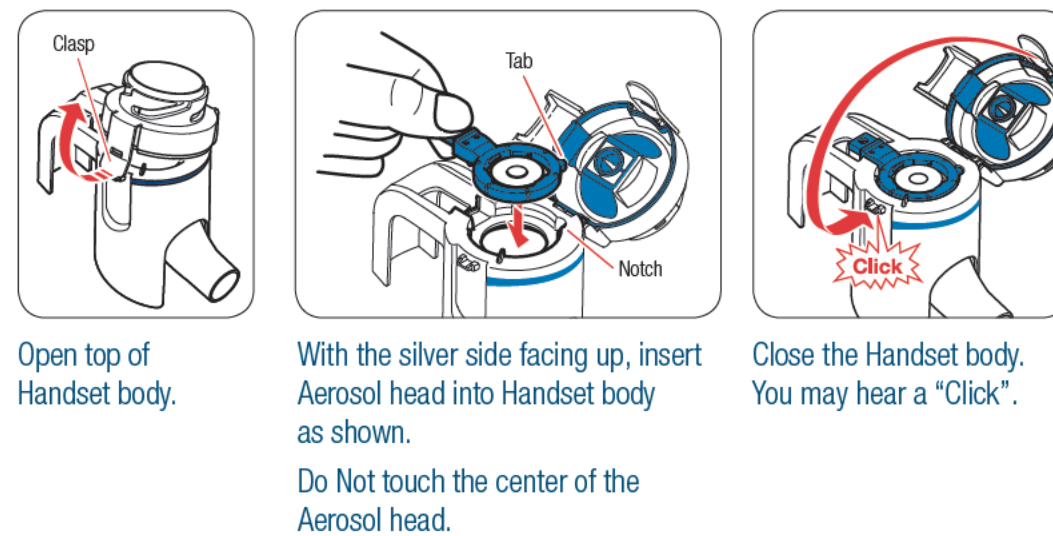

Open top of Handset body. With the silver side facing up, insert Aerosol head into Handset body as shown. Do Not touch the center of the Aerosol head. Close the Handset body. You may hear a "Click".

3 Attach Mouthpiece.

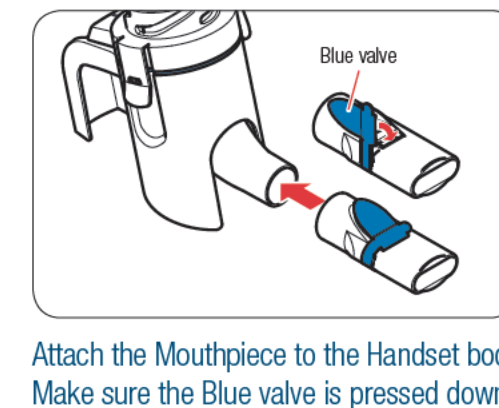

Attach the Mouthpiece to the Handset body. Make sure the Blue valve is pressed down.

4 Attach Connection cord.

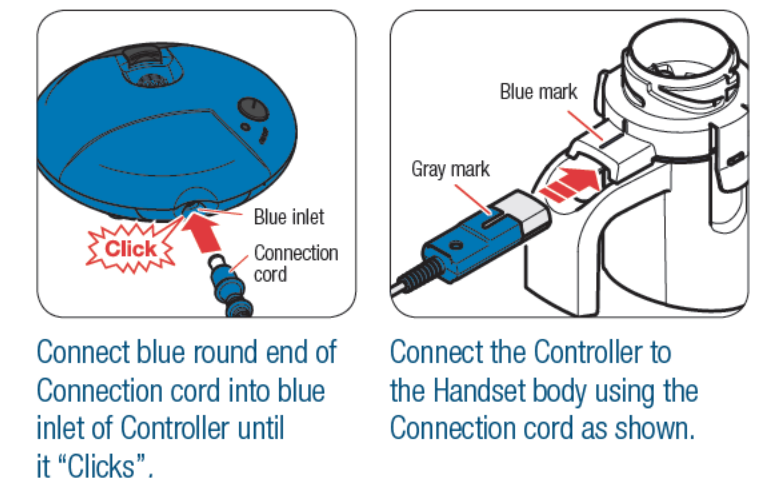

Connect blue round end of Connection cord into blue inlet of Controller until it "Clicks". Connect the Controller to the Handset body using the Connection cord as shown.

5 Open foil and separate vials.

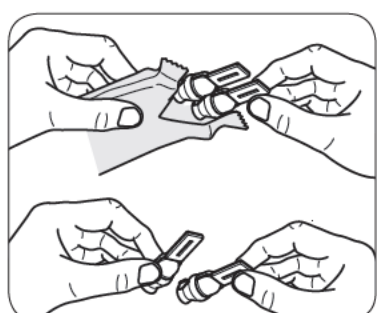

Open the foil pouch enough to remove the 2 LONHALA vials and separate them. Return 1 vial to the opened foil pouch and store in the Carrying bag to be used at your next treatment. Discard the vial if not used within 7 days.

6 Insert LONHALA vial and attach Medication cap.

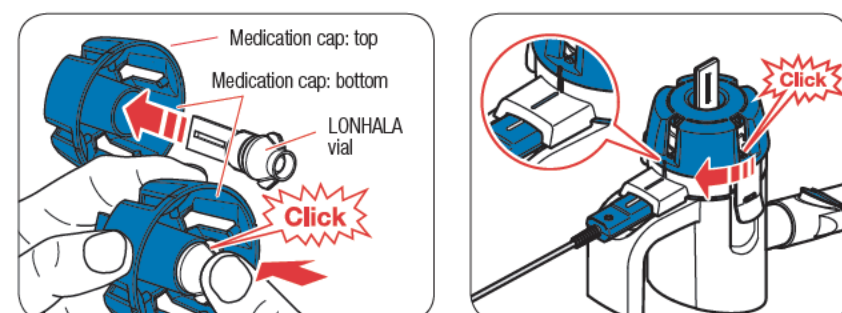

Insert LONHALA vial into bottom of Medication cap until it "Clicks". Make sure the Aerosol head is installed before attaching the Medication cap. Place Medication cap with LONHALA vial on top of Handset body. Turn Medication cap clockwise onto Handset body until it "Clicks".

Do Not loosen or remove the Medication cap or unclasp the Handset body until treatment is complete.

7 Using LONHALA MAGNAIR

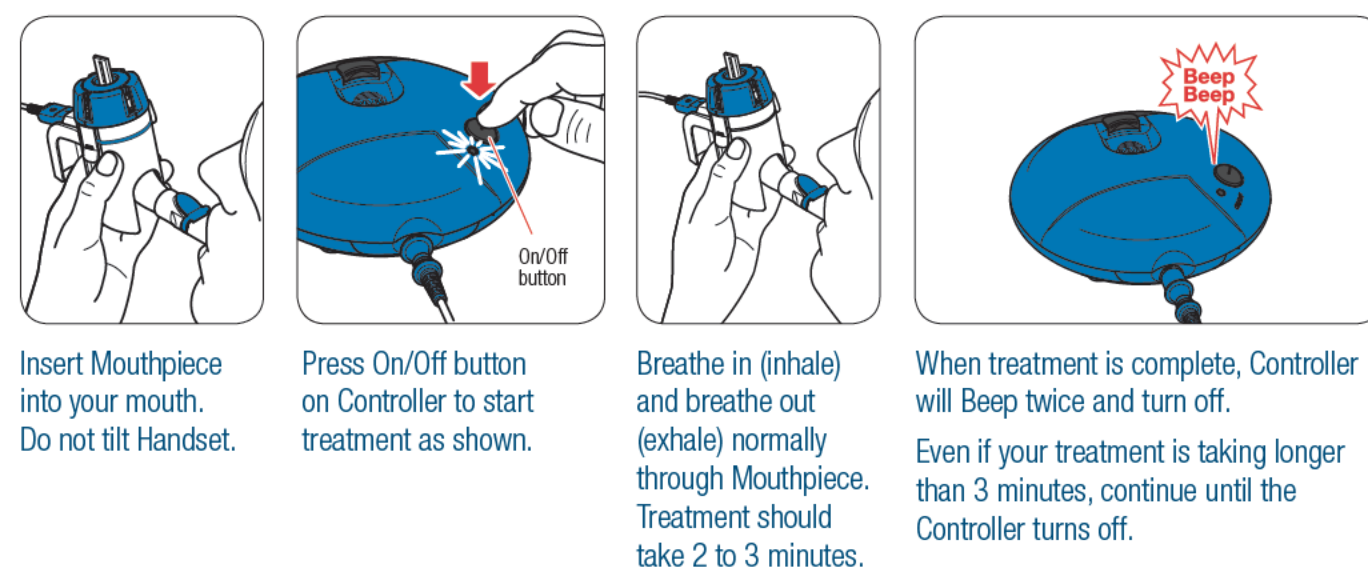

Insert Mouthpiece into your mouth. Do not tilt Handset. Press On/Off button on Controller to start treatment as shown. Breathe in (inhale) and breathe out (exhale) normally through Mouthpiece. Treatment should take 2 to 3 minutes. When treatment is complete, Controller will Beep twice and turn off. Even if your treatment is taking longer than 3 minutes, continue until the Controller turns off.

Rinse and clean the Handset after use. Do Not leave the Aerosol head in the Handset.

Cleaning the Handset

Cleaning the Handset after each use helps maintain a 2 to 3 minute treatment time. Treatment can take longer if you do not clean the Handset.

8 Disassemble Handset.

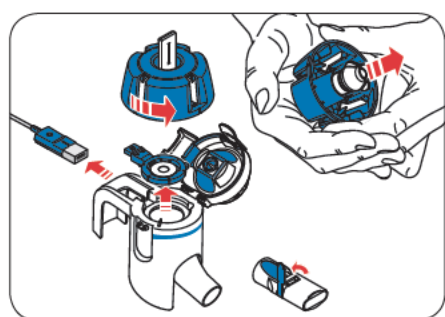

Disassemble Handset parts in preparation for cleaning as shown. Open Blue valve on Mouthpiece. Remove LONHALA vial by placing Medication cap into the palm of your hand and pushing up. Throw away the LONHALA vial into the wastebasket.

9 Rinse.

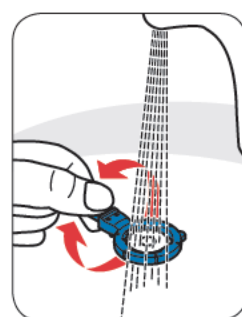

Keep Aerosol head separate from other Handset parts and rinse each side well with warm running water for 10 seconds.

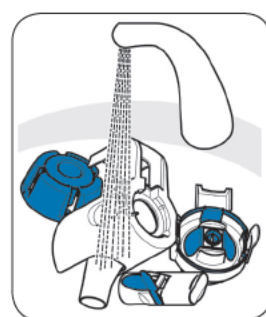

Rinse each Handset part under warm running water for 10 seconds.

10 Wash.



Hold the Aerosol head handle and swish it back and forth in the warm soapy water for 10 seconds.

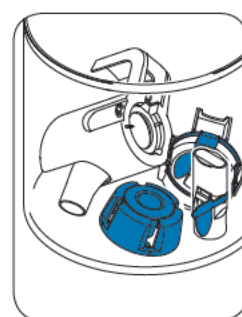

Wash all Handset parts in warm soapy water for 10 seconds.

11 Rinse.

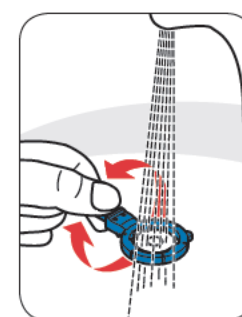

Keep Aerosol head separate from other parts and rinse each side well with warm running water for 10 seconds. Inspect Handset parts to make sure they are completely clean. If any parts are still dirty, soak the parts for 5 more minutes. Rinse well with warm running water until the parts are clean.

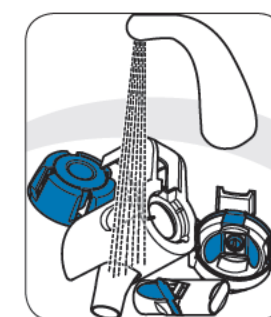

Rinse each Handset part under warm running water for 10 seconds.

12 Dry.

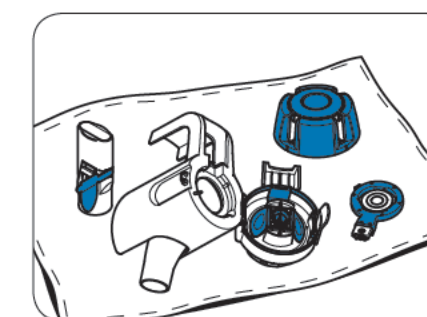

Shake each Handset part to remove excess water. Let parts air-dry on a lint-free towel.

Storing LONHALA MAGNAIR

13 Store disassembled Handset parts.



After the Handset parts are completely dry, place in the Carrying bag or a dry, dust-free environment for storage.

Reassemble the Handset just prior to the next treatment. Do Not put the Handset parts back together until ready to use again for your next dose of LONHALA.

Reminder: Do Not clean your Handset parts with alcohol or put in the dishwasher, as this will damage the parts.



PLACEBO INSTRUCTIONS FOR DEMONSTRATION

Using the MAGNAIR™ Nebulizer System

This placebo and MAGNAIR Nebulizer System is for demonstration only. it is not for inhalation or therapeutic use and should not be distributed to patients.

Read, understand, and follow this Instruction for Use leaflet and the manufacturer's instructions for use booklet before PLACEBO demonstration with the MAGNAIR Nebulization System. The manufacturer's instructions for use booklet provides complete information about how to put together (assemble), prepare, use, care for, and trouble-shoot your MAGNAIR Nebulizer System.

This kit will help you to demonstrate to patients the assembly and handling of the MAGNAIR Nebulizer System. The MAGNAIR Nebulizer System provided with this **Demonstration Kit should only be used with the enclosed PLACEBO vials which are not to be used for inhalation by the patient.**

The PLACEBO does not contain an active ingredient or medication. The PLACEBO is supplied as a sterile solution for inhalation in single-use low-density polyethylene (LDPE) vials overwrapped in a foil pouch. Demonstration kits containing 60 vials of PLACEBO (2 vials of PLACEBO in each pouch; 1 vial per demonstration) Each 1 mL vial contains a solution of 20 mM citrate buffer (pH 4.0) and sodium chloride in Water for Injection (WFI).

Please explain and instruct your patients on how to assemble and use the PLACEBO and MAGNAIR Nebulizer System with the aid of the diagrams in this leaflet.

These Instructions for Demonstration contain information and safety precautions for the MAGNAIR for use with PLACEBO as Demonstration Only.

Your Demonstration Kit:

The following supplies come with your Demonstration Kit:

Starter Kit: Foil pouches containing 60 vials of PLACEBO (2 vials of PLACEBO in each pouch; 1 vial per demonstration), Instructional video, and 1 MAGNAIR Nebulizer System with carrying bag (including Manufacturer's instructions for use booklet and Quick Reference Guide) (see the figure below).

Refill Kit: Foil pouches containing 60 vials of PLACEBO (2 vials of PLACEBO in each pouch; 1 vial per demonstration), and 1 MAGNAIR refill Handset (containing only these replacement parts: Medication cap, Handset body, Mouthpiece, and Aerosol head; Manufacturer's instructions for use booklet).

Important: Throw away the old Handset parts after using 60 vials of PLACEBO and use the replacement Handset parts in the Refill Kit with the next 60 vials of PLACEBO.

MAGNAIR Nebulizer System



Important: Check to make sure that your MAGNAIR Nebulizer System works properly before starting your demonstration with PLACEBO. See manufacturer’s instructions for use booklet that comes with your MAGNAIR Nebulizer System.

Steps for Using Batteries or AC Adapter with MAGNAIR

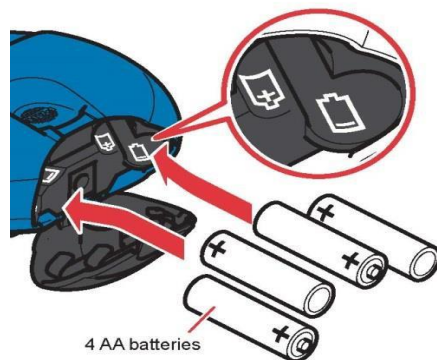
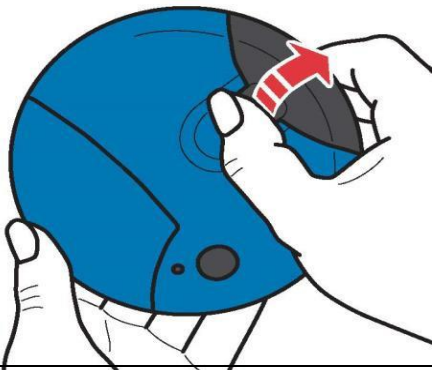

Step 1: Open the battery door on the Controller. Placing your thumb on the black tab of the battery door and firmly pushing the tab to open the door.

Step 2: Put 4 AA batteries in the Controller as shown.

Step 3: Close the battery door. You may hear a “click”.

Important: Make sure to have an extra set of batteries with you at all times if you choose not to use the AC adapter.

Steps for Using the AC Adapter with MAGNAIR

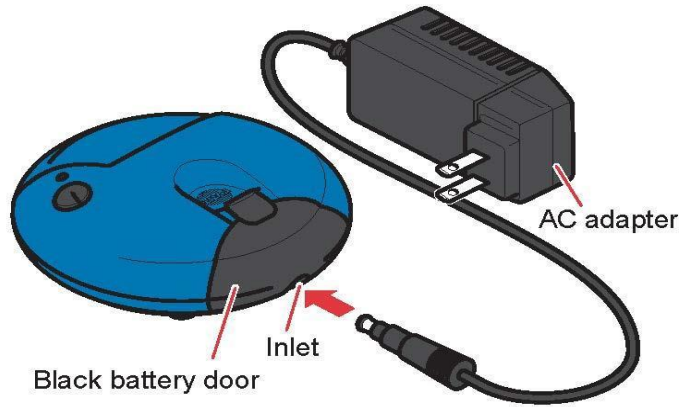

Step 1: Plug the AC adapter into the Inlet on the battery door of the Controller.

Step 2: Plug the AC adapter into the wall outlet.

Assembling Your MAGNAIR

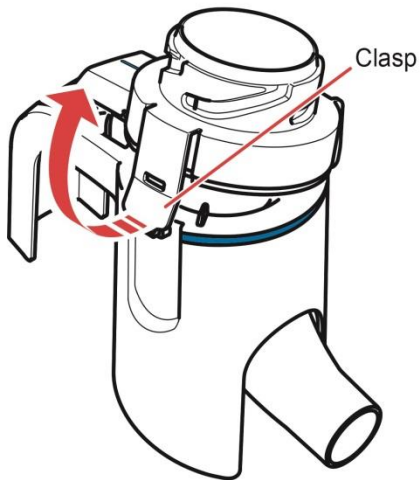

Step 1: Wash your hands.

Step 2: Open the top of the Handset body by lifting the clasp.

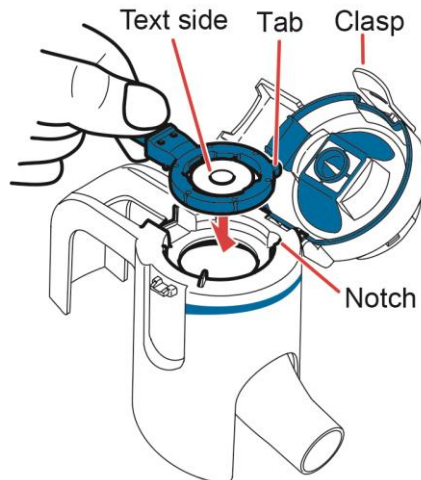

Step 3: Insert the Aerosol head into the Handset body as shown. **Do not** touch the center of the Aerosol head. Notice that the Aerosol head has a small tab on the side. Align the small tab with the matching notch in the Handset body.

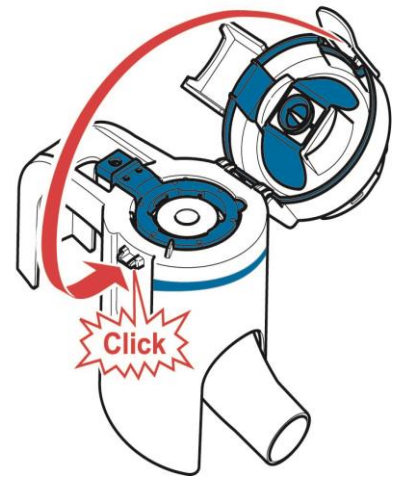

Step 4: Close the Handset body. You may hear a “Click”.

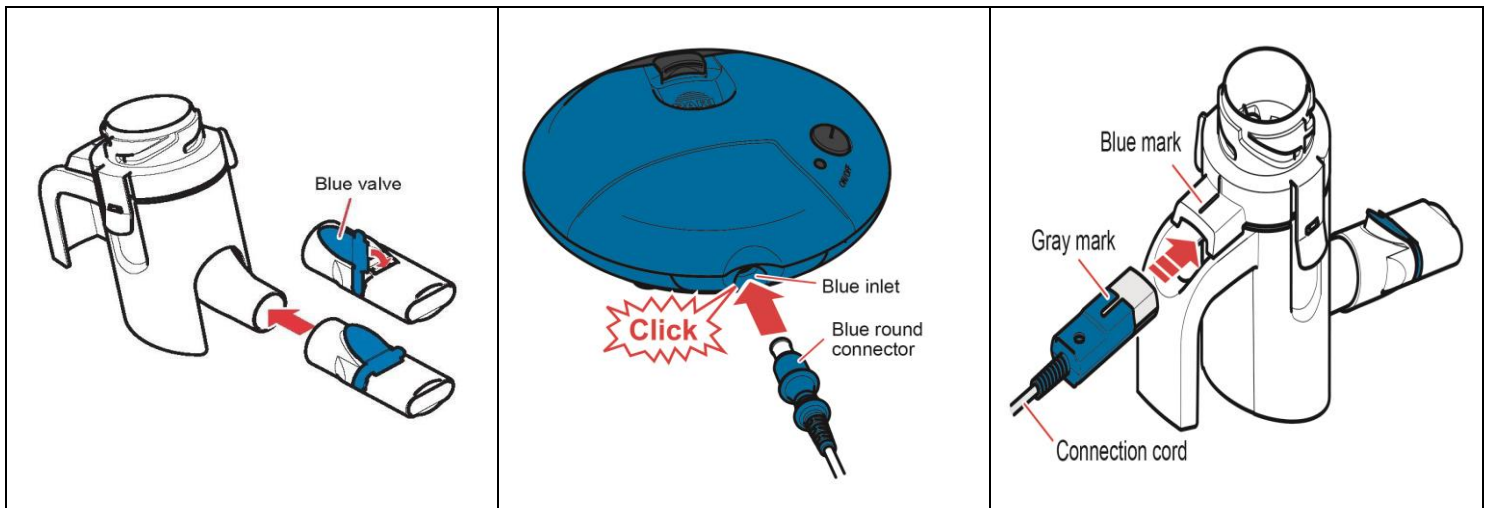

Step 5: Attach the Mouthpiece to the Handset body. Make sure the Blue valve is pressed down.

Step 6: Connect the Controller to the Handset body using the Connection cord. You may hear a “Click”.

Step 7: Connect the Controller to the Handset body using the Connection cord as shown.

Demonstrating MAGNAIR with PLACEBO

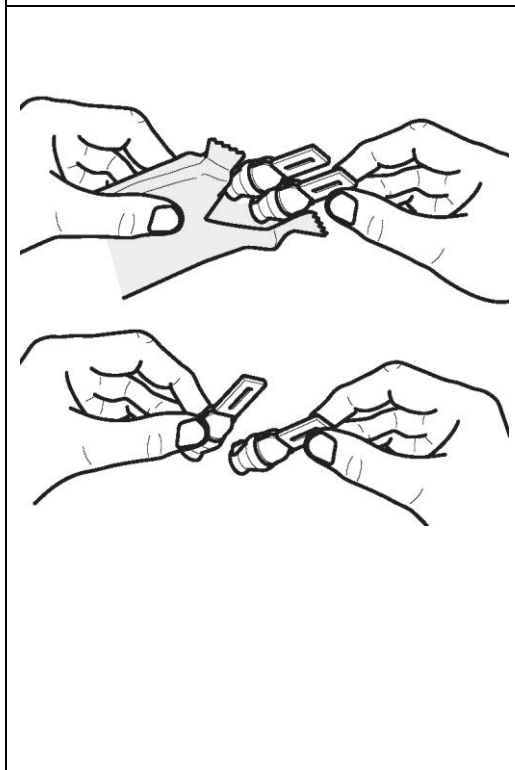

Step 1: Open the foil pouch enough to remove the 2 PLACEBO vials and separate them. Return 1 vial to the opened foil pouch and store in the carrying bag to be used at the next demonstration.

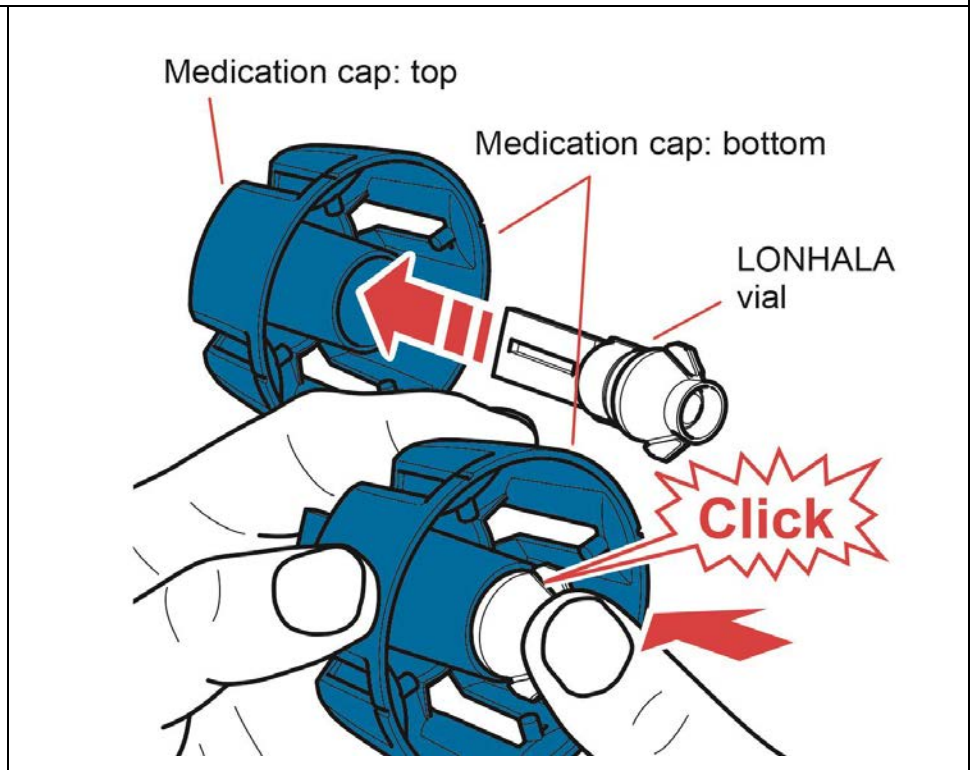

Step 2: Insert one PLACEBO vial into the bottom of the Medication cap until it “Clicks”.



Important: Do not touch the part of the Handset body that pierces the vial

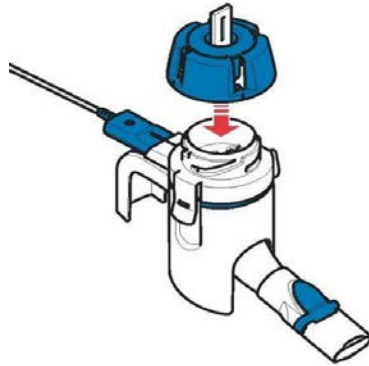

Step 3: Make sure the Aerosol head is installed before attaching the Medication cap because your PLACEBO could leak. Place the Medication cap with PLACEBO vial on the top of the Handset body.

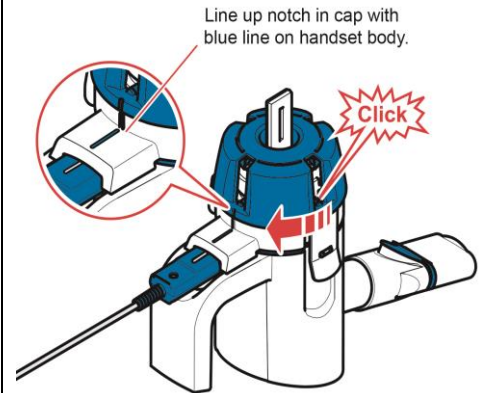

Step 4: To attach the Medication cap to the Handset body, turn the Medication cap in a clockwise direction as shown, until you hear a “Click”. The notch in the Medication cap (at the base of the opening) should line up with the blue line on the Handset body.
Important: Do not tilt the Handset, loosen or remove the Medication cap, or unclasp the Handset body until the demonstration is complete.

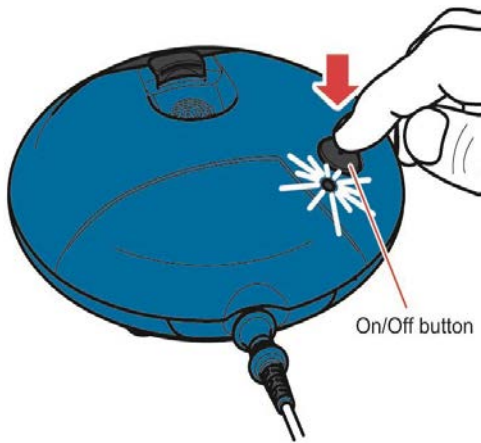

Step 6: Press the On/Off button to start your demonstration as shown. **Do not** insert the Mouthpiece into the patient’s mouth. PLACEBO is for demonstration purposes only.

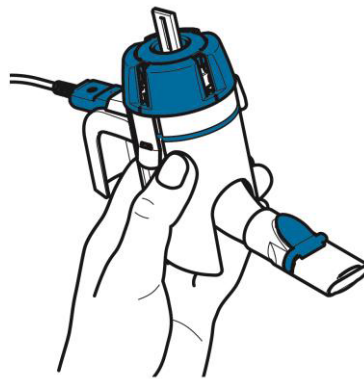

Step 7: Explain to the patient that they would breathe in (inhale) and breath out (exhale) normally through the Mouthpiece. **Do not** insert the mouthpiece into the patient’s mouth.



At the end of your demonstration, you will hear a beeping sound and the Controller will automatically shut off. The demonstration should take about 2 to 3 minutes.

Cleaning The Handset

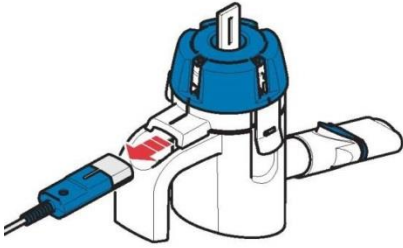

Step 1: Disconnect the Handset from the Connection cord.

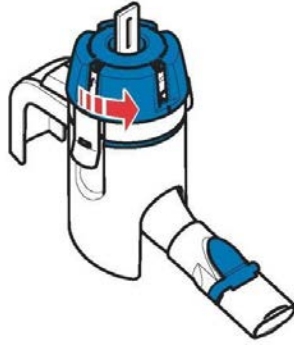

Step 2: Turn the Medication cap in a counter clockwise direction as shown, to remove it from the Handset body

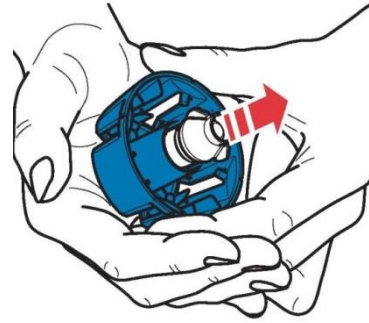

Step 3: Place the top of the Medication cap into the palm of your hand and push up as shown to remove the PLACEBO vial. Throw away the PLACEBO vial into the wastebasket.

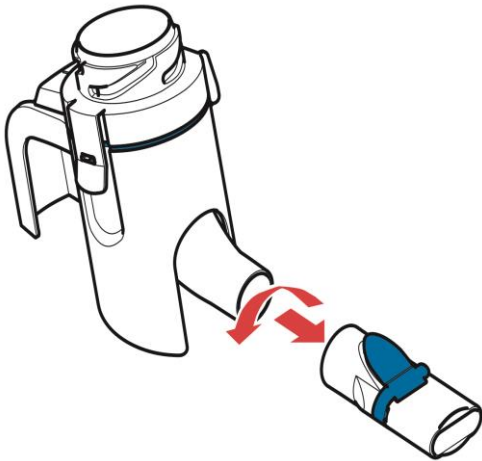

Step 4: Remove the Mouthpiece from the Handset body by giving it a gentle twist and pull to separate from the Handset body

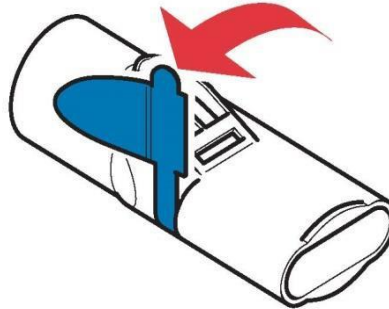

Step 5: Carefully loosen the blue valve from the slot in the Mouthpiece. Make sure the valve is still attached on one side to the Mouthpiece

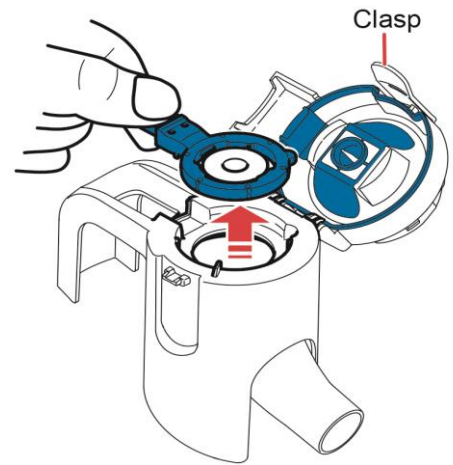

Step 6: Remove the Aerosol head from the Handset body by lifting the clasp on the side of the Handset body as shown.

Do not touch the center of the Aerosol head.

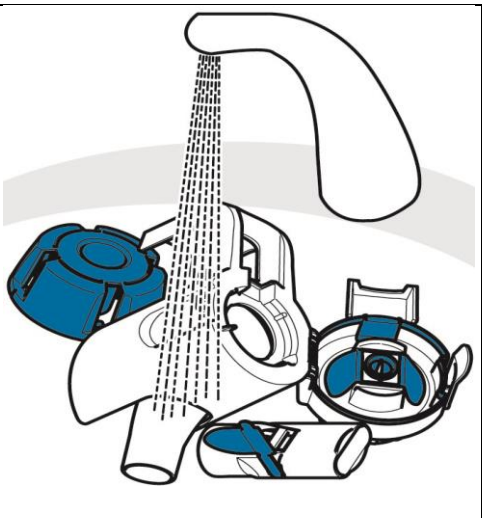
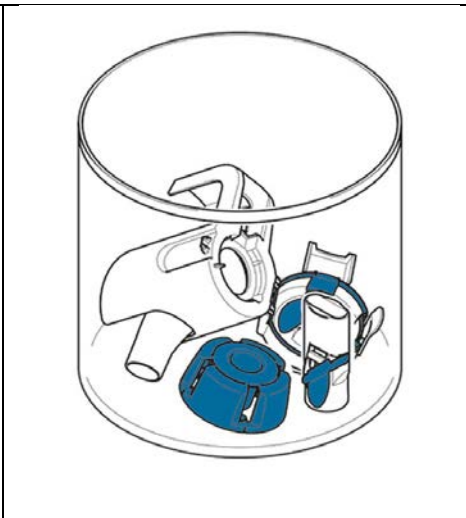
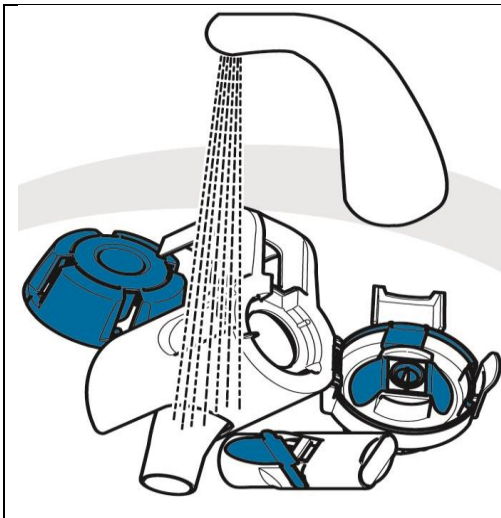

Step 7: Set aside the Aerosol head to be cleaned separately (see Step 10). Rinse all Handset parts well with warm running water for about 10 seconds

Step 8: Wash all Handset parts in warm soapy water (water and clear liquid dishwashing soap) for about 10 seconds.

Step 9: Rinse the Handset parts well with warm running water for about 10 seconds.

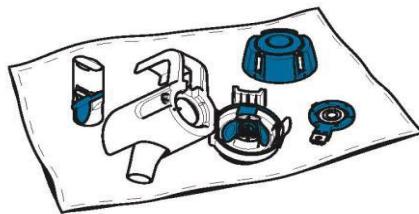
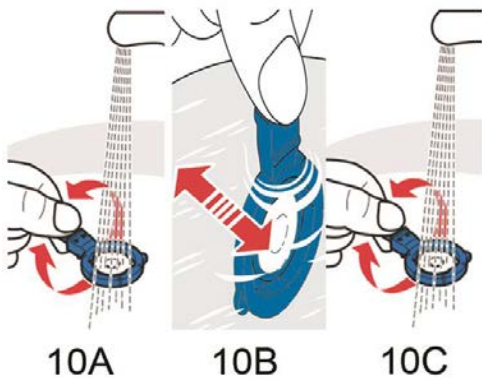

Step 10: Clean the Aerosol head using the instructions in Steps 7 -9.
 10A. Rinse each side of the Aerosol head well with warm running water for about 10 seconds.
 10B. Hold the Aerosol head by the handle and swish it back and forth in the warm soapy water for about 10 seconds.
 10C. Then, rinse both sides of the Aerosol head well with warm running water for about 10 seconds on each side.

Rinsing the Aerosol head well helps prevent clogging and ensure proper operation.

Step 11: Inspect all Handset parts to make sure they are completely clean. If any Handset parts are still dirty, soak the parts in warm soapy water for 5 more minutes. Rinse well with warm running water until the Handset parts are clean. Shake Handset parts to remove excess water. Air-dry all Handset parts on a lint-free towel. **Do not** put the Handset parts back together until ready to use again for your next Demonstration.

Step 12: Store disassembled Handset parts in the carrying bag provided.

Remember:

To ensure proper operation, it is **IMPORTANT** to:

- Check all parts of your MAGNAIR to make sure they are clean and not damaged.
- Clean the Handset parts before the first use and after every use. If you do not clean the Handset parts after every use, your Demonstration could take more than 3 minutes.
- **Do not** leave the Aerosol head in your Handset.
- **Do not** wash the Controller, Connection cord, or AC adapter.
- Only use clear liquid dishwashing soap to wash the Handset parts. **Do not** use any other type of soap.
 - **Do not** use antibacterial soap. Antibacterial soap can damage the Aerosol head.
- **Do not** use a microwave oven to dry any part of your MAGNAIR.
- Allow all Handset parts of your MAGNAIR to air dry completely

If you have any questions, contact the Sunovion Customer Service at 1-888-394-7377.

This Instruction for Use has been approved by the U.S. Food and Drug Administration.

MAGNAIR is a trademark of PARI Pharma GmbH, used under license.

SUNOVION and  are registered trademarks of Sumitomo Dainippon Pharma Co., Ltd. Sunovion Pharmaceuticals Inc. is a U.S. subsidiary of Sumitomo Dainippon Pharma Co., Ltd.

PARI and  are registered trademarks of PARI GmbH.
eFlow is a registered trademark of PARI Pharma GmbH.
Made under license of The Technology Partnership plc.

Demonstration Kit provided by:

Sunovion Pharmaceuticals Inc.

Marlborough, Massachusetts 01752 USA

© 2017 Sunovion Pharmaceuticals Inc. All rights reserved.

Issued: December 2017

902021R00

This is a representation of an electronic record that was signed electronically and this page is the manifestation of the electronic signature.

/s/

LYDIA I GILBERT MCCLAIN
12/05/2017