

# ResQ CPR™ System

REORDER #12-0825-000

## INSTRUCTIONS FOR USE

### ResQPOD® ITD 16

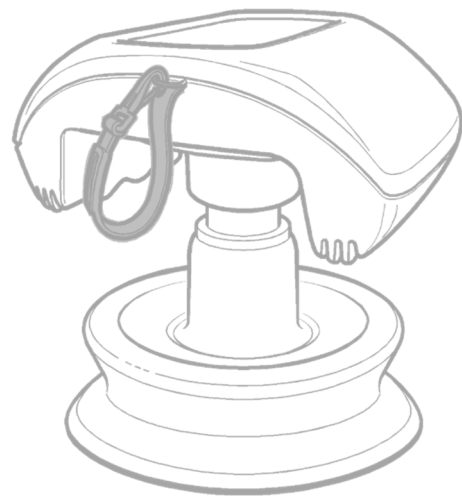

### ResQPUMP® ACD-CPR Device

 **Advanced Circulatory®**  
*Perfusion on Demand*

## TABLE OF CONTENTS

User Information, Required Skills and Prescription Use	2
Indications for Use, Contraindications, Warnings, Precautions	3
ResQPUMP ACD-CPR Device Description and Instructions for Use	4
ResQPOD ITD 16 Device Description and Instructions for Use	5
Performing ResQCPR	6-10
ResQPUMP ACD-CPR Device Care, Function Testing and Force Gauge Calibration	11-13
Clinical Trial Information	14-18
Technical Specifications, Patents, Replacement Parts	19-21

### USER INFORMATION

All users must read and fully understand these ResQCPR System Instructions for Use (IFUs) before using the ResQCPR System or any of its components. The ResQCPR™ System includes the following components:

1. ResQPUMP® ACD-CPR Device
2. ResQPOD® ITD 16



The use of other medical equipment or drugs in conjunction with cardiopulmonary resuscitation (CPR) may impact the effect of compressions/decompressions. Consult the instructions for use for other equipment or drugs to assure that they are used appropriately in conjunction with active compression decompression CPR (ACD-CPR) with an impedance threshold device (ITD) - the ResQCPR System.

### REQUIRED SKILLS

The ResQCPR System should be used only by persons with appropriate training, such as ambulance and rescue personnel, or other medical staff who have already completed a conventional CPR course (e.g. American Heart Association, American Red Cross, or equivalent), and who have been trained on use of the ResQCPR System.



### RX ONLY

Federal Law (USA) restricts this device system to sale by or on the order of a licensed medical practitioner.

### **INDICATIONS FOR USE**

The ResQCPR System is intended for use as a CPR adjunct to improve the likelihood of survival in adult patients with non-traumatic cardiac arrest.

### **CONTRAINDICATIONS**

None known.

### **WARNINGS**



Improper use of the ResQCPR System could cause serious injury to the patient and ineffective chest compressions/ decompressions. The ResQCPR System should only be used by personnel who have been trained in its use.



Improper positioning of the ResQPUMP suction cup may result in possible injury to the rib cage and/or internal organs, and may also result in suboptimal circulation during ACD-CPR.



Do not use the ResQPUMP if the patient's chest is not large enough for the ResQPUMP suction cup to provide adequate compressions/decompressions during use.



Moisture, gels, or other lubricating materials on the patient's chest should be removed before applying the ResQPUMP. Failure to do so may result in sliding of the suction cup on the chest, ineffective chest compressions/decompressions, and possible injury to the rib cage or internal organs.



The ResQPUMP should not be used in patients who have had a recent sternotomy. Use of the ResQPUMP in patients with a recent sternotomy (within the past 6 months) has not been evaluated, but this may potentially cause serious injury.

### **PRECAUTIONS**



The safety and effectiveness of CPR using the ResQCPR System have not been assured when used to treat cardiac arrest in patients with drug/medication overdose etiology.



If the patient has a return of spontaneous circulation (ROSC) (e.g. palpable pulse) during the resuscitation efforts, the ResQPOD should be immediately removed from the airway circuit and use of the ResQPUMP should be discontinued. Failure to do so may cause shortness of breath, difficulty breathing and potential pulmonary edema if the patient begins to breathe spontaneously.



The ResQCPR System has not been studied in the setting of in-hospital cardiac arrest. Therefore, the safety and effectiveness of the device in this setting are unknown. Clinical outcomes when using the ResQCPR System in the setting of an in-hospital cardiac arrest may be different from the outcomes observed in the clinical trials of out-of-hospital cardiac arrest.



Safety and effectiveness of the ResQCPR System in pregnant women and children under the age of 18 have not been studied in clinical trials.



Safety and effectiveness of the ResQCPR System in the setting of traumatic injury (wounds resulting from sudden physical injury) have not been established.

The ResQCPR™ System includes the following two components:

1. ResQPUMP® ACD-CPR Device
2. ResQPOD® ITD 16

## ResQCPR System Component: ResQPUMP ACD-CPR Device

### DEVICE DESCRIPTION

The ResQPUMP ACD-CPR Device (hereafter referred to as ResQPUMP) (Figure 1) is a multi-use, hand-held device that includes a suction cup for attachment to the patient's chest (with clothing removed), and a handle for the rescuer to hold onto.

**Figure 1: ResQPUMP ACD-CPR Device**

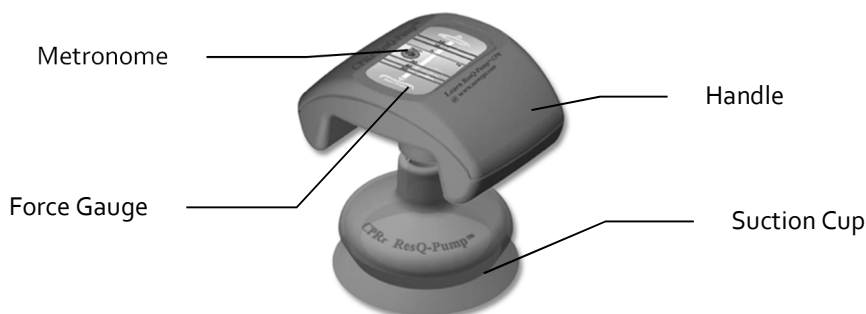

The ResQPUMP **enables the rescuer to perform active compression-decompression cardiopulmonary resuscitation (ACD-CPR)**, which differs from standard CPR. During ACD-CPR, the chest is actively re-expanded (decompressed) after each compression; with standard CPR, the chest re-expands passively. The ResQPUMP design allows the operator to use the same body position and compression technique as in standard CPR. Active chest decompression is achieved when the rescuer maintains a firm grip on the ResQPUMP, bends at the waist and pulls his or her body weight upwards after compression. The suction cup sticks to the chest and transfers the lifting force to the middle of the ribcage. Compression force is transferred to the chest as in standard CPR via the device's piston. The handle includes a force gauge that displays the forces exerted during both chest compression and decompression (chest wall recoil). The ResQPUMP has a battery-powered metronome integrated into the handle to guide the rescuer in the appropriate compression/decompression rate. The metronome emits two-tone signals of the same duration, one low and one high pitch tone. The signal (set at 80/minute) guides the rescuer to compress and decompress at the appropriate rate and for equal amounts of time (50% duty cycle).

If suction difficulties occur, adjust the angle of the ResQPUMP on the chest to obtain an adequate seal. It may be necessary to shave hair from the middle of the chest to achieve good suction. NOTE: If suction difficulties persist, the ResQPUMP can still be used for compressions without causing additional harm to the patient, as long as it does not distract from CPR quality.

## ResQCPR System Component: ResQPOD ITD 16

**Figure 2:**



### **INSPECTION PRIOR TO USE**

Carefully inspect the ResQPOD in its package before opening. Do not use if package is opened or damaged, or if any defects are noted.

### **HOW SUPPLIED**

The ResQPOD ITD 16 is non-sterile and intended for single patient use only. Dispose of properly when use is completed.

### **DEVICE DESCRIPTION**

The ResQPOD ITD 16 (hereafter referred to as ResQPOD) (Figure 2) is a non-sterile, single patient use, disposable impedance threshold device (ITD) that **limits passive air entry into the lungs during the chest wall recoil (decompression) phase of CPR**, thereby reducing intrathoracic pressure when rescuers are not providing a breath. Lowered intrathoracic pressure results in greater venous return (preload) which, in turn, results in greater cardiac output on the subsequent compression. It is inserted into the airway circuit between the patient and the ventilation source, and can be used with either a facemask or advanced airway (e.g. endotracheal [ET] tube). The ResQPOD may be used with standard ventilation sources (e.g. bag-valve or demand-valve resuscitators, rescuer's mouth, automated ventilator). It does not restrict the patients' ability to exhale, nor the rescuer's ability to ventilate. The ResQPOD allows the rescuer to provide periodic positive pressure ventilation while impeding passive inspiratory gas exchange during the chest recoil phase. The ResQPOD ITD 16 includes a safety check valve that allows inspiration at  $-16 \text{ cmH}_2\text{O}$ . The check valve is a design safety feature in the event that the patient begins to breathe independently while the device is in place within the airway circuit. Timing assist lights provide guidance to the rescuer on the proper ventilation rate for a patient with an advanced airway.

## PERFORMING CPR USING THE RESQCPR SYSTEM



Before beginning CPR with the ResQCPR System (ACD-CPR with an ITD; Figure 3), always assess the patient according to local standards to assure there are no signs of circulation (e.g. consciousness, breathing, coughing, movement or pulse). Begin performing CPR with the ResQCPR System as soon as possible but do not delay manual chest compressions while preparing the ResQCPR devices.

**Figure 3: Use of the ResQCPR System**

### PERFORMING CPR USING THE RESQCPR SYSTEM IN ADULTS

1. Assure that patient is pulseless and that resuscitation is indicated.
2. Place ResQPUMP; turn on metronome and begin performing compressions to appropriate depth (e.g. 2" or 5 cm) depth at rate of 80/min (see additional detailed instructions on the use of the ResQPUMP below).
3. Attach ResQPOD to facemask as soon as chest compressions begin; use a 2-handed technique to maintain a tight facemask seal and airway position (see additional detailed instructions on the use of the ResQPOD below).
4. After 30 compressions, pause and administer two ventilations over one second duration each until the chest rises.
5. Continue to provide a 30:2 compression to ventilation ratio until pulse returns or advanced airway is placed. Rotate ACD-CPR duties every two minutes to avoid fatigue.
6. Once an advanced airway (e.g. ET tube, supraglottic airway) is placed:
  - Confirm tube placement and secure with commercial tube restraint.
  - Move the ResQPOD to the airway and turn on the timing assist lights.
  - Provide asynchronous ventilations; ventilate once (over one second until chest rises) each time light flashes (10/min).
  - Perform continuous chest compressions at 80/min. Do not pause compressions for ventilations.
  - Rotate ACD-CPR duties every two minutes to avoid fatigue.
7. If the patient has a return of spontaneous circulation (ROSC) the ResQPOD should be immediately removed from the airway circuit and use of the ResQPUMP should be discontinued. If the patient re-arrests, resume use of the ResQCPR System immediately.

NOTE: Signs and symptoms of improved cerebral blood flow (e.g. eye opening, gagging, spontaneous breathing, limb or body movement) have been reported in patients without a spontaneous pulse but who are undergoing resuscitation with the ResQCPR System. If these are noted, check quickly to see if a spontaneous pulse has returned. If the patient remains in cardiac arrest, continue resuscitation with the ResQCPR System and contact your medical control authority or local protocol for guidance on managing these signs and symptoms in an arrested patient. If a spontaneous pulse has returned, discontinue the ResQCPR System and support ventilations as indicated.

## PERFORMING CPR WITH THE RESQCPR SYSTEM (continued)

### THE RESQCPR TEAM

It is highly recommended that rescuers work in teams of 3 - 4 people. This enables one person to perform ACD-CPR, one person to hold the facemask in place with the ResQPOD attached, and a third person to manage the defibrillator and observe the patient for signs of ROSC. In this team scenario, the person compressing the chest can stop after 30 compressions to provide two positive pressure breaths (<5 seconds), before resuming chest compressions. With more personnel, two rescuers can manage the airway.

### ENSURING HIGH QUALITY CPR WITH THE RESQCPR SYSTEM

- Check the ResQPUMP's force gauge at regular intervals to ensure that the appropriate forces needed to compress and decompress are being delivered.
- Use the ResQPUMP's metronome as a guide for compressing and decompressing at the rate of 80/min. NOTE: This rate is slightly slower than the rate recommended for standard CPR in order to allow sufficient time for blood return to the chest, and to reduce rescuer fatigue.
- Rotate ACD-CPR duties every two minutes to avoid fatigue.
- Once the patient has an advanced airway place, use the ResQPOD's timing assist lights to guide the proper ventilation rate. Ventilate over one second duration and do not hyperventilate!
- Avoid unnecessary interruptions.

### DETAILED INSTRUCTIONS RELATED TO THE USE OF THE RESQPUMP

Proper use of the ResQPUMP is shown in **Figures 4 through 9**.

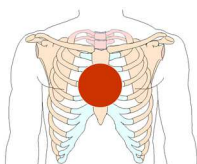

**Figure 4**

#### RESQPUMP POSITIONING

The ResQPUMP's compression point is the same as for standard manual CPR (Figure 4). Position the suction cup in the middle of the sternum between the nipples (mid-nipple line). Make sure that the edge of the suction cup does not extend below the xiphoid process, as this could result in inadequate suction and/or rib injury.

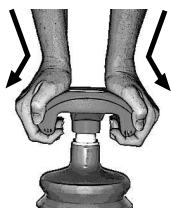

**Figure 5**

#### RESCUER POSITION

Kneel close to the patient's side. For optimal position, shorter rescuers may find it beneficial to be slightly elevated by kneeling on padding. If the patient is in bed (with hard surface under torso), it will be necessary to kneel next to the patient or stand on a platform of sufficient height. Grasp the ResQPUMP's handle with both hands, placing the heels of the hands near the gauge with wrists slightly bent (Figure 5).

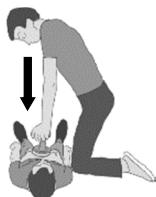

**Figure 6**

#### COMPRESSIONS WITH THE RESQPUMP

Compress the chest to the recommended depth (e.g. 2" or 5 cm), observe the force required to achieve that depth, and then use that force target as a guide. The amount of force required will vary according to how compliant the chest is. Compress with shoulders directly over the sternum, with arms outstretched and elbows locked (Figure 6). Use the large thigh muscles to compress, bending at



the waist. Compress at a rate of 80/min and use the metronome to guide the compression rate. Start and stop the metronome by pressing the red button on the force gauge (Figure 7). Compress the chest on one tone and lift on the other tone. **Note: The compression rate using the ResQPump (80 compressions per minute) is different than the current 2010 AHA-recommended rate of 100-120 compressions per minute for standard CPR.**

### COMPRESSION FORCE

The red arrow tip indicates the force being applied (Figure 7). The approximate amount of force required to compress the chest two inches (5 cm) is as follows:

- 30 kg ( $\approx$  65 lb) of force: soft/supple chest
- 30 - 40 kg ( $\approx$  65 - 90 lb) of force: chest of medium/average compliance (Fig. 7)
- 50 kg ( $\approx$  110 lb) of force: stiff/rigid chest

Once it has been determined how much force is required to compress the chest to the appropriate depth, use that amount of force as a guide for continued compressions.

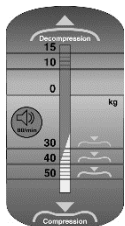

**Figure 7**



**Figure 8**

### DECOMPRESSIONS WITH THE RESQPUMP

To provide active decompression, use the large muscles in the thighs to lift, bending at the waist (Figure 8).

### DECOMPRESSION FORCE

Decompress (lift) the chest until the tip of the red arrow on the force gauge registers -10 kg ( $\approx$  -20 lb) of force (Figure 9). This amount of upward force must be exerted to fully achieve the benefits of active decompression. Closely monitor the force gauge and suction cup seal during use. If the suction cup dislodges, reposition it with the next compression; then, on the next decompression, lift until just before the suction cup releases but do not exceed -10 kg ( $\approx$  -20 lb) of lift. Use a 50% duty cycle, spending equal time compressing and decompressing.

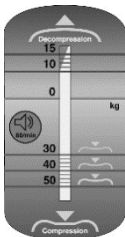

**Figure 9**

### SUCTION CUP REMOVAL

Lift up an edge of the suction cup lip to release the vacuum under the cup. This will free the cup from the patient's chest.

### TROUBLESHOOTING

1. If suction difficulties occur, adjust the angle of the ResQPUMP on the chest to obtain an adequate seal. It may be necessary to shave hair from the middle of the chest to achieve good suction. NOTE: If suction difficulties persist, the ResQPUMP can still be used for compressions (with the metronome disabled) without causing additional harm to the patient, as long as it does not distract from CPR quality.
2. Rib fractures can occur with any method of CPR, even if performed correctly. If it appears that rib fractures have occurred, check to make sure the suction cup is properly positioned and that compression depth is appropriate. The occurrence of rib fractures is not sufficient reason to discontinue ACD-CPR.

3. If there are questions about whether the ResQPUMP is functioning properly, consider discontinuing its use and perform standard manual CPR instead.

### DETAILED INSTRUCTIONS RELATED TO THE USE OF THE RESQPOD ON A FACEMASK



Figure 10



Figure 11



Figure 12



Figure 13

1. It is important to insert the ResQPOD into the ventilation circuit as soon as chest compressions begin. In most cases this will involve placement on a facemask; however, never delay the initiation of chest compressions while waiting to place the ResQPOD.
2. The ResQPOD may be used on patients with or without an oral or nasal airway.
3. Attach the ResQPOD to the facemask. (Figure 10)
4. **Obtaining and maintaining a tight facemask seal throughout both chest compressions and ventilations is critical.** To achieve this, spread out the cushion of the mask. (Figure 11)
5. Use a two-handed technique to maintain proper airway positioning and obtain a tight facemask seal. Place the facemask onto the patient, covering the nose and mouth. Obtain a tight facemask seal by either:
  - A. Using the thumb and base of the palm (Figure 12); or
  - B. Forming a "C" with thumb and index finger.
6. Place the remaining fingers on the bony part of the lower jaw and lift the lower jaw to the facemask. Do not push the facemask into the face to try and obtain a seal.
7. Tilt the head back and continue to lift the lower jaw to the mask. (Figure 13)
8. Attach the ventilation source to the top of the ResQPOD.
9. DO NOT turn on timing assist lights. If rescue personnel elect to perform continuous chest compressions and ventilate asynchronously with a facemask, then the lights may be turned on and the rescuer should provide a positive pressure ventilation on the upstroke of ACD-CPR every time the light flashes.
10. Administer ResQCPR using the proper compression to ventilation ratio (e.g. 30:2) and the proper ventilation duration (e.g. one second).
11. If there is only one rescuer available to manage the airway, then the rescuer who is performing chest compressions can reach over and provide ventilations during the pause in chest compressions, while the rescuer at the airway maintains a two-handed facemask seal. (Figure 13)
12. The ResQPOD is disposable and intended for single patient use. Cross contamination may occur if the device is used on multiple patients.

**DETAILED INSTRUCTIONS RELATED TO USING RESQPOD ON AN ADVANCED AIRWAY (E.G. ET TUBE):**



Figure 14



Figure 15

1. Insert the advanced airway and confirm tube placement. Secure the tube with a commercial tube restraint device. The use of tape to secure the tube is not recommended.
2. Attach the ResQPOD to the top of the airway and attach the ventilation source to the top of the ResQPOD (Figure 14); avoid interrupting CPR to do this.
3. Turn on the timing assist lights. To activate, slide the ON/OFF switch to the ON position.
4. Perform ResQCPR with continuous chest compressions (no pauses for ventilations). Ventilate asynchronously when the timing lights flash (10/min) and over proper duration (e.g. one second) until the chest rises.
5. If an end-tidal carbon dioxide detector is used, place it in the airway circuit between the ResQPOD and the ventilation source. (Figure 15)
6. If there is desire to administer medications via the advanced airway, remove the ResQPOD and administer medications directly into the tube, then re-connect ResQPOD and resume use.

**ADDITIONAL INSTRUCTIONS:**

1. If there is a return of spontaneous circulation (e.g. palpable pulse) and chest compression are no longer indicated, immediately remove the ResQPOD from the airway circuit. Failure to do so may cause shortness of breath and difficulty breathing. Support respirations as indicated.
2. Immediately replace the ResQPOD in the ventilation circuit if the patient re-arrests and chest compressions are again indicated.
3. If vomit or secretions enter the ResQPOD, remove the ResQPOD from the facemask or airway adjunct and use the ventilation source to clear the material from the ResQPOD. Suction the patient as needed, then re-attach the ResQPOD and resume use. Discontinue use of the ResQPOD if it cannot be cleared or if positive pressure ventilation is compromised in any way with the device in place.

### **FOLLOWING EACH USE OF THE RESQCPR SYSTEM**

The ResQPOD is intended for single patient use only and should be discarded after use. Failure to do so may cause cross contamination between patients. The ResQPUMP should be cleaned and disinfected after every use.

### **RESQPUMP CLEANING**

To clean the handle, wipe with damp cloth and mild detergent. The suction cup may be replaced with a new suction cup, or cleaned. To clean the suction cup, wash it with a mild detergent and rinse with tap water.



Never immerse the handle in water or autoclave to clean. Doing so may cause permanent damage.

### **RESQPUMP CHEMICAL DISINFECTION**

The handle and suction cup may be chemically disinfected after washing. Wipe the cup and handle with a bleach solution (5% chlorine, minimum) or Cavicide® (follow manufacturer instructions for wetting times). Wipe the handle with a dampened cloth to remove chemical residue. Do NOT immerse the handle. The cup may be rinsed with water. Wipe with a clean dry cloth and allow to air dry.



Hazards during disinfection. Always wear protective clothing during disinfection of the ResQPUMP. Follow the handling instructions from the manufacturer of the disinfectant.

NOTE: The cleaning procedure is sufficient after 'normal' soiling. If there are bodily fluids on the ResQPUMP or if an infectious patient has been treated, the ResQPUMP should also be disinfected as described above and the suction cup should be discarded and replaced.

### **RESQPUMP FUNCTION TESTING**

Before placing the ResQPUMP into service and following each use, the following functional tests should be performed:

1. Inspect the handle and suction cup for visible damage. Do not use the ResQPUMP if there is obvious damage to the suction cup or handle. NOTE: Replacement suction cups are available from the manufacturer.
2. Compress the ResQPUMP against a smooth hard surface with approximately 50 kg of force, using the force gauge on the ResQPUMP as a guide. Observe for an increasing gauge reading.
3. Pull up on the handle with approximately 10 to 15 kg of force, using the decompression force gauge as a guide. Observe for a decreasing gauge reading and check for proper suction. The gauge should move smoothly within the compression and decompression ranges.
4. Ensure that the force gauge reads zero (Figure 16) when no force is applied. If it does NOT read zero, see instructions for force gauge calibration below.
5. Assess the metronome's battery level by pressing on the metronome button for more than three seconds. If the battery is okay, first, a long high-note beep will be heard, followed by three short beeps. If one long low-note beep is heard, or if no beep is heard, the device should be replaced as well.

### **FORCE GAUGE CALIBRATION**

If the zero reading of the force gauge (Figure 16) has drifted away from the zero line, the gauge should be readjusted as follows:

1. Remove the suction cup by pulling it from the stem of the handle.
2. Use a Torx™ tool (size T20) to loosen the screw at the top of the connection stem (Figure 17) with a firm turn. Remove the nylon stem, nylon spacer and washer located inside the stem (Figure 18).
3. Insert a straight blade screwdriver (4 mm [ $\frac{1}{8}$ "] wide) in threaded hole at the end of the spring/plunger assembly and catch the slot of the adjustment screw seated about 1.5 cm ( $\frac{5}{8}$ " ) down inside the brass plunger (Figure 18).
4. Loosen the screw. If there is excessive resistance, heat the screw slightly using a hairdryer to soften the locking resin (Figure 19).
5. Loosen the screw and adjust it until the gauge is on the zero line (Figure 16). Compress the spring a few times and check that the zero reading remains correct. Fine readjustment may be needed. If the screw was heated, wait until it cools to room temperature before proceeding to the next step.
6. Lock the screw by applying a drop of LOCTITE 242 locking fluid (or equivalent) to top of screw. Use a toothpick to ensure that the fluid is applied directly to the top of the screw. Wait ten minutes for the locking fluid to set.
7. Reassemble in reverse order. Place the nylon spacer and washer into the nylon stem as shown in Figure 20. Apply a drop of locking fluid to the tip and the thread near the end of the screw. Push the screw up through the end of the stem and through the spacer and washer.
8. Finally, slip the spring/plunger on the handle down into the stem. Rotate the stem until it lines up with the handle and slips all the way into the handle, then tighten the screw.
9. Wait 24 hours before using the device to ensure that the locking resin obtains full strength. During this time, the ResQPUMP should be hung by the strap or left resting on the handle with the suction cup pointing up.

**Figure 16**

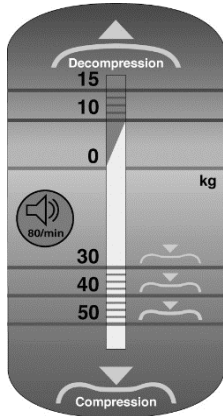

**Figure 17**

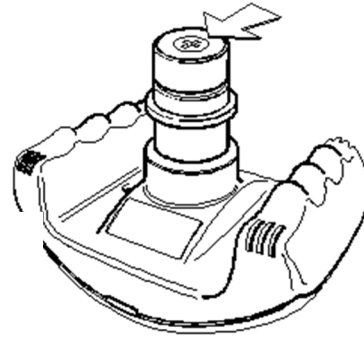

**Figure 18**

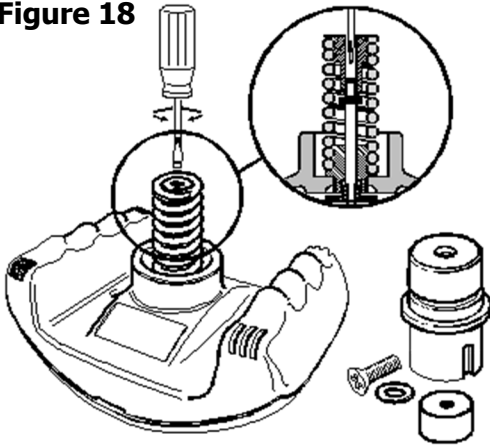

**Figure 19**

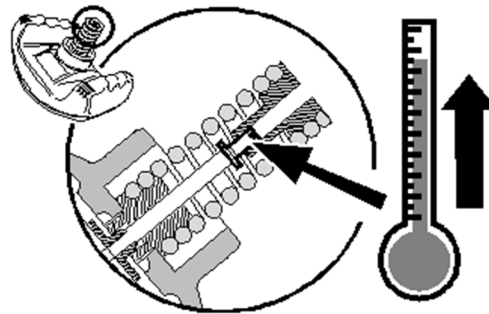

**Figure 20**

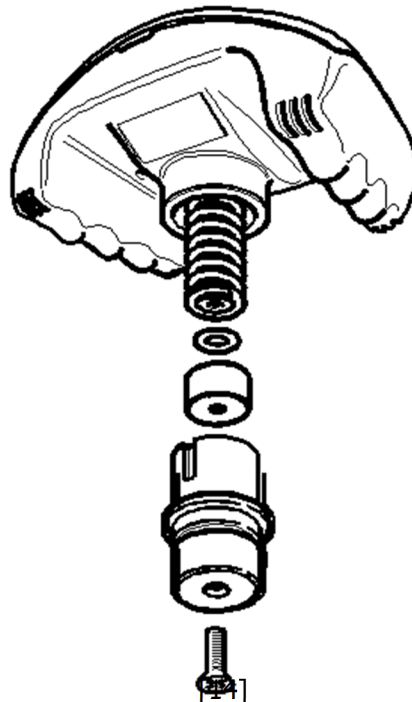

## Summary of Primary Clinical Study

### Study Design and Methods

The ResQTrial was a prospective, multi-center, two-arm, randomized, controlled, partially masked clinical study conducted under 21 C.F.R. §50.24, *Exemption from Informed Consent under Emergency Circumstances*, and was funded by a grant from the National Institutes of Health (NIH). Study oversight was conducted by an independent Clinical Events Committee responsible for the review of all adverse events and inclusion/exclusion adjudication and an independent Data Safety Monitoring Board to review aggregate data to provide recommendations whether or not to continue subject enrollment.

Rescuers provided CPR using the ResQCPR System at 80 compressions per minute (the S-CPR group received compressions at the AHA-recommended rate of 100 compressions per minute). Patients were followed for one year after cardiac arrest to determine if the ResQCPR System improved survival rates after cardiac arrest. Neurological outcomes were assessed at the time of hospital discharge, and then 30, 90 and 365 days after cardiac arrest.

The principal data elements which led to device approval were a post hoc analysis of survival up to one year after cardiac arrest not incorporating the consideration of neurological function. The primary safety and effectiveness endpoint defined in the protocol was survival to hospital discharge with favorable neurologic function, defined as a modified Rankin Scale score (MRS) of  $\leq 3$ . The MRS assessment takes into consideration the subject's neurologic status both prior to and following cardiac arrest. However, conclusions and inferences regarding the original prospective primary endpoint for the ResQTrial (i.e., survival with good neurological outcome) cannot be drawn from the ResQTrial due to interpretability issues related to the neurological component of that composite endpoint. The hypothesis-based secondary safety endpoint was the overall rate of major adverse events through hospital discharge. The hypothesis-based secondary effectiveness endpoint was long term neurologic function assessed using the Cognitive Abilities Screening Instrument (CASI, Version E-1.1) Score at 90 and 365 days. CASI is measured on a scale of 0-100, with higher scores signifying better outcomes.

All subjects in non-traumatic arrest determined by emergency medical services (EMS) personnel to require CPR according to their local protocols were randomized and treated in this study. The intention-to-treat (ITT) population was comprised of all subjects randomized to S-CPR or CPR using the ResQCPR System who met the study enrollment criteria regardless of the cause of the non-traumatic cardiac arrest. A subset of the ResQTrial ITT population was comprised of patients who had a cardiac arrest of presumed cardiac etiology and who have the potential to benefit from CPR. This subgroup was defined as the modified intention-to-treat (mITT) primary analysis population. Baseline demographics and parameters were similar between study groups as shown in Table 1.

**Table 1: ResQTrial Pivotal Phase Demographics and Baseline Characteristics<sup>1</sup>**

Parameter	S-CPR		ResQCPR	
	ITT (n=1201)	mITT (n=813)	ITT (n=1269)	mITT (n=842)
Age, years (mean ± SD)	64.2 ± 17.2	66.8 ± 14.5	63.3 ± 17.8	67.0 ± 15.2
Male	752 (62.6)	539 (66.3)	803 (63.3)	559 (66.4)
Race:				
White	960 (79.9)	660 (81.2)	1035 (81.6)	715 (84.9)
Asian	39 (3.2)	31 (3.8)	29 (2.3)	19 (2.3)
Native Hawaiian/ Pacific Islander	4 (0.3)	3 (0.4)	1 (0.1)	1 (0.1)
American Indian/Alaska Native	18 (1.5)	9 (1.1)	22 (1.7)	10 (1.2)
Black/African American	152 (12.7)	94 (11.6)	155 (12.2)	88 (10.5)
Unknown	28 (2.3)	16 (2.0)	26 (2.1)	9 (1.1)
Ethnicity:				
Hispanic/Latino	22 (1.8)	15 (1.8)	32 (2.5)	19 (2.3)
Not Hispanic/Latino	1149 (95.7)	782 (96.2)	1207 (95.2)	811 (96.3)
Unknown	30 (2.5)	16 (2.0)	29 (2.3)	12 (1.4)
Bystander witnessed arrest	517 (43.1)	383 (47.1)	546 (43.2)	400 (47.5)
EMS witnessed arrest	146 (12.2)	76 (9.4)	144 (11.4)	80 (9.5)
Unwitnessed arrest	536 (44.7)	353 (43.4)	575 (45.5)	361 (42.9)
Not available	2	1	4	1
Bystander CPR	489 (40.7)	350 (43.1)	532 (42.0)	358 (42.5)
Not available	1	1 (0.1)	2	0 (0.0)
Initial recorded cardiac rhythm:				
Ventricular fibrillation/pulseless ventricular tachycardia	294 (24.5)	247 (30.4)	335 (26.4)	292 (34.7)
Asystole	597 (49.7)	379 (46.6)	633 (49.9)	376 (44.7)
Pulseless electrical activity	293 (24.4)	180 (22.1)	284 (22.4)	171 (20.3)
Not available	17	7 (0.9)	16	3 (0.4)
911 call to EMS CPR start, minutes <sup>2</sup> (mean ± SD)	6.7 ± 3.5	6.6 ± 3.4	6.7 ± 3.2	6.7 ± 3.2
911-to-first study device placed, minutes (mean ± SD) <sup>2</sup>	-	-	7.1 ± 3.5	7.1 ± 3.5
Duration CPR, minutes (mean ± SD)	25.6 ± 13.0	27.60 ± 12.24	26.3 ± 12.3	28.10 ± 11.45
Pre-hospital ROSC <sup>3</sup>	490 (40.8)	324 (39.9)	524 (41.3)	345 (41.0)

<sup>1</sup>Numbers shown are subjects (%) unless otherwise indicated

<sup>2</sup>Does not include subjects with EMS witnessed arrests

<sup>3</sup>ROSC = Return of spontaneous circulation

## Safety and Effectiveness Results

### Survival

One of the major objectives of the ResQTrial was to determine the safety and effectiveness of the ResQCPR treatment from the time of a return of spontaneous circulation (ROSC) to survival status one year later; this is shown in Table 2. The results demonstrated that the likelihood of short and longer-term survival was improved in the ResQCPR arm. At one year, there was a 33% increase in the survival rate in subjects in the ITT population receiving CPR with the ResQCPR System compared with S-CPR.



**Table 2: Survival of Out-of-Hospital Cardiac Arrest Subjects from ROSC to One Year<sup>1</sup>**

	ITT		mITT	
	S-CPR (n=1201)	ResQCPR (n=1269)	S-CPR (n=813)	ResQCPR (n=842)
ROSC during CPR before hospital admission	490 (40.8)	524 (41.3)	324 (39.9)	345 (41.0)
Admitted to hospital	342 (28.5)	381 (30.0)	216 (26.6)	239 (28.4)
Survived to 24 hours following arrest	277 (23.1)	310 (24.4)	176 (21.6)	199 (23.6)
Not available	12	11	9	6
Alive at hospital discharge	123 (10.2)	150 (11.8)	80 (9.9)	105 (12.5)
Not alive at hospital discharge	1072	1114	727	735
Not available	6	5	6	2
Alive at 30 days	98 (8.2)	131 (10.3)	65 (8.1)	96 (11.5)
Not alive at 30 days	1086	1123	738	741
Not available	17	15	10	5
Alive at 90 days	88 (7.3)	116 (9.1)	58 (7.3)	87 (10.4)
Not alive at 90 days	1089	1129	740	746
Not available	24	24	15	9
Alive at 1 year	68 (5.7)	96 (7.6)	48 (6.0)	74 (9.0)
Not alive at 1 year	1103	1137	746	748
Not available	30	36	19	20

<sup>1</sup>Numbers shown are subjects (%) unless otherwise indicated.

Kaplan Meier survival analyses were performed in the subgroup of subjects who had a return of spontaneous circulation (ROSC) for both the ITT and mITT populations (where the number of subjects with ROSC is shown above in Table 1). The findings in these analyses are consistent with the overall study results. The Kaplan Meier curves in Figure 21 show that the majority of subjects with ROSC do not survive post-hospitalization after out of hospital cardiac arrest. However, the Kaplan Meier estimate of survival at one year was a 30% higher in subjects in the ITT population receiving CPR with the ResQCPR System compared with S-CPR (22.7% vs. 17.5%).

**Figure 21: Kaplan Meier analysis of subjects with ROSC following out-of-hospital cardiac arrest**

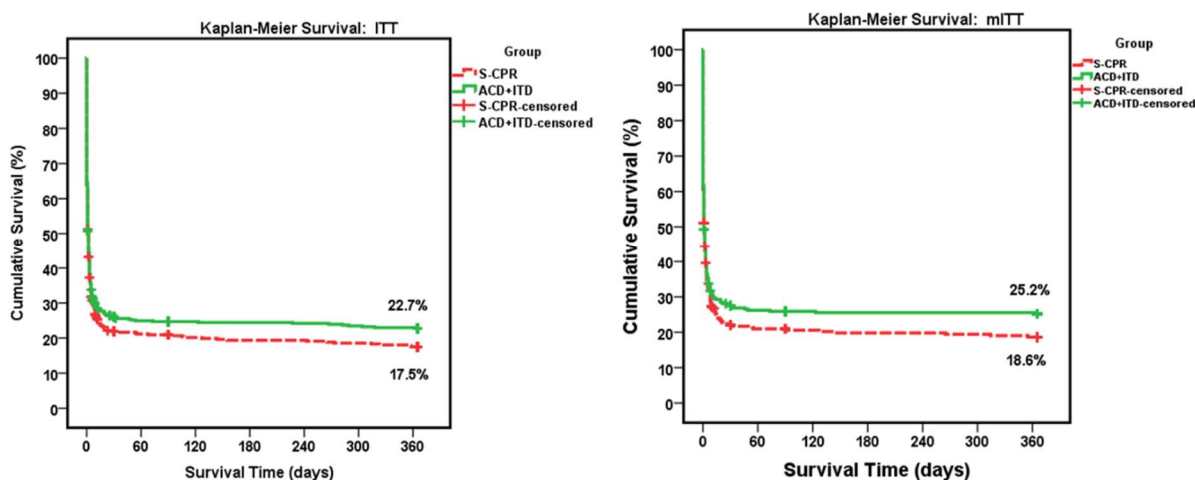

Importantly, there was no increase in the number of subjects with severe neurologic impairment in the ResQCPR group, that is, the neurological outcome in patients who received CPR with the ResQCPR System appeared to be no worse than the control (S-CPR). In the mITT, proportional differences between the two treatment groups were observed to become larger

over time. Approximately 50% more subjects receiving CPR with the ResQCPR System were alive one year after OHCA compared with those treated with S-CPR. However, this comparison was not prospectively specified or adjusted for multiplicity.

### Secondary Safety Endpoint

The analysis of safety was based on the randomized cohort of 2470 subjects in the ITT population and 1655 subjects in the mITT subgroup available for the evaluation prior to hospital discharge. The safety analysis included major adverse events that were reported during the pre-hospital resuscitation effort and up to the point of hospital discharge, as applicable. There were no differences in overall major adverse event rates between the study groups in the mITT population; thus the secondary safety endpoint was met. Reported major adverse events by type are shown in **Table 3**.

**Table 3: ResQTrial (Out-of-Hospital Cardiac Arrest) Subjects with Major Adverse Events through Hospital Discharge<sup>1</sup>**

Event	ITT		mITT	
	S-CPR (n= 1201)	ResQCPR (n= 1269)	S-CPR (n=813)	ResQCPR (n=842)
Subjects with ≥1 major adverse event through hospital discharge (secondary safety endpoint <sup>2</sup> )	1129 (94.0)	1194 (94.1)	766 (94.2)	789 (93.7)
Death	1074 (89.4)	1115 (87.9)	729 (89.7)	735 (87.3)
Re-arrest	230 (19.2)	260 (20.5)	161 (19.8)	185 (22.0)
Stroke/cerebral bleeding	11 (0.9)	11 (0.9)	3 (0.4)	2 (0.2)
Internal organ injury	2 (0.2)	2 (0.2)	0 (0.0)	1 (0.1)
Hemothorax	3 (0.3)	3 (0.2)	1(0.1)	2 (0.2)
Bleeding requiring intervention	8 (0.7)	17 (1.3)	3 (0.4)	7 (0.8)
Cardiac tamponade	4 (0.3)	5 (0.4)	3 (0.4)	2 (0.2)
Aspiration	20 (1.7)	16 (1.3)	7 (0.9)	8 (1.0)
Pneumothorax	11 (0.9)	13 (1.0)	7 (0.9)	10 (1.2)
Seizure	19 (1.6)	23 (1.8)	13 (1.6)	11 (1.3)
Rib/Sternal fracture	23 (1.9)	18 (1.4)	14 (1.7)	11 (1.3)
Pulmonary edema <sup>3</sup>	96 (8.0)	143 (11.3)	62 (7.6)	94 (11.2)

<sup>1</sup> Numbers shown are subjects with at least one report of the listed adverse event types. If multiple events of same type were reported, the event is only counted once per subject. Reports of deaths, re-arrest, seizure, and pulmonary edema in the field (e.g., pre-hospital) are also shown. All other adverse event types were assessed based on review of medical records for subjects transported to a hospital. There were no Major Adverse Events associated with device malfunctions, defects, or failures.

<sup>2</sup> Secondary safety endpoint: The rate of major adverse events in the ResQCPR group (mITT) was found to be non-inferior to that in S-CPR group ( $p < 0.0001$ ) within a non-inferiority margin of 5%.

<sup>3</sup> Data shown includes combined pre-hospital and in-hospital reports of pulmonary edema. Pulmonary edema was defined as any of the following: *Prehospital reports* of advanced airway filled with fluid  $\geq 2$  times; blood, mucous, fluid or other secretions in the airway; reports of pulmonary edema or pleural/pulmonary effusion on post-mortem examinations; and, for subjects transported to a hospital, *in-hospital reports* of pulmonary edema or pleural/pulmonary effusion confirmed on x-ray or CT scan. Pre-hospital pulmonary edema was reported in 22 patients (2.7%) in the S-CPR group, and in 30 patients (3.6%) in the ResQCPR group (mITT).

The only difference in adverse events between the two groups was the observation that more patients receiving CPR with the ResQCPR System had pulmonary edema. A *post hoc* analysis

appeared to demonstrate that the presence of pulmonary edema did not adversely affect effectiveness as measured by survival.

#### Secondary CASI Effectiveness Endpoint

The pre-specified secondary effectiveness endpoint was an evaluation of long-term neurological function using Mean Cognitive Abilities Screening Instrument (CASI) scores at 90 and 365 days. The study was not able to demonstrate an improvement in neurologic function in the ResQCPR arm based on CASI scores (as was hypothesized); however, CASI scores were not significantly different among survivors who were discharged from the hospital. The mean scores included subjects who died after hospital discharge, with a CASI score equal to 0 assigned to those who died. More than 85% of the one-year survivors in both study arms completed the one-year CASI assessment and the mean CASI scores for these subjects were  $93.7 \pm 11.8$  (n=30) in the S-CPR arm and  $94.7 \pm 4.4$  (n=41) in the ResQCPR arm for the mITT, consistent with full or nearly full recovery in both groups; ITT scores were  $91.9 \pm 13.5$  (n=43) in the S-CPR arm and  $92.3 \pm 12.3$  (n=49) in the ResQCPR arm.. There were only three patients with CASI scores <70, a score consistent with poor neurological function, in both groups. There is limitation in interpreting the comparison of these CASI results between groups, since the comparison is not based on all randomized patients but rather is conditional on the survival of subjects at 90 days or 1 year.

#### Subjects with a Drug/Medication Overdose

A *post-hoc* analysis of subjects with a presumed medication or drug overdose, as determined by CEC adjudication, suggested that CPR using the ResQCPR System in this patient population may have resulted in unfavorable clinical results for drug/medication overdose patients as compared to both 1) S-CPR for drug/medication overdose patients, and 2) CPR utilizing the ResQCPR System for non-traumatic arrest patients not having drug/medication overdose as the arrest etiology. Among S-CPR and ResQCPR subjects with drug/medication overdose arrest etiologies, 20% of S-CPR (13/65) and 14% of ResQCPR (14/97) subjects survived to hospital discharge.

#### **Overall Conclusions**

The results of the pivotal trial demonstrate that the ResQCPR System increased the likelihood of survival after non-traumatic out-of-hospital cardiac arrest when compared with manual S-CPR, the current standard of care for treatment of out-of-hospital cardiac arrest in the United States today. One year survival rates were relatively 33% higher when CPR was performed with the ResQCPR System compared with S-CPR for all subjects in the ITT population (7.6% vs. 5.7%), and relatively 49% higher for those in the mITT population (9.0% vs. 6.0%). These principal data elements which led to device approval by FDA and are accordingly represented in the labeling and indications for use for the ResQCPR System were a post hoc analysis of survival not incorporating the consideration of neurological function. One year after OHCA, more than 95% of surviving subjects in both treatment groups had excellent neurological function, as determined by cognitive, functional, and quality of life testing. In cardiac arrest of etiology known to be drug/medication overdose, the favorable results with use of the ResQCPR System may not be present.

<b>RESQPOD ITD 16 TECHNICAL SPECIFICATIONS</b>	
<b>Operating Specifications</b>	
Safety check valve threshold	-16 cmH <sub>2</sub> O
Expiratory airway impedance	<5 cmH <sub>2</sub> O
Timing assist lights flash rate	10/min
<b>Shelf Life</b>	Four years
<b>Temperature Range</b>	
Operation	-18° to 50° C (0° to 122° F)
Storage	-40 to 60° C (-40° to 140° F)
<b>Dimensions</b>	
Height	8.2 cm
Diameter	5.3 cm
Circumference	16.6 cm
Patient side connection	15 mm ID/22 mm OD
Ventilation side connection	22 mm ID
Dead space	41 ml
Weight	62 gm
<b>Materials</b>	
Exterior housing and interior molded components	Polycarbonate
Diaphragm and safety check valve gasket	Silicone
Safety check valve spring	Nickel plated stainless steel
Battery	3 V disposable lithium ion coin cell



ResQPOD and ResQPUMP are registered trademarks of Advanced Circulatory. These products and their use are protected by one or more of the following patents: USA – 5,645,522; 6,155,257; 6,224,562; 6,234,985; 6,312,399; 6,425,393; 6,463,327; 6,587,726; 8,151,790. Foreign – CNZL96193712.2; EP0898485 (France, Germany, Italy, Sweden, United Kingdom). Other USA and country patents pending.

<b>ResQPUMP ACD-CPR Device Technical Specifications</b>	
<b>Operating Specifications</b>	
Force gauge compression range	0 to 50 kg $\pm$ 15%
Force gauge decompression range	0 to 15 kg $\pm$ 15%
<b>Metronome Function</b>	
Signal pitches	768 Hz (low) and 3070 Hz (high)
Sound level	$\geq$ 65 dB at distance of 0.5 m for sound source
Rate	80/min
<b>Temperature Range</b>	
Operation	-18 $^{\circ}$ to 50 $^{\circ}$ C (0 $^{\circ}$ to 122 $^{\circ}$ F)
Storage	-40 to 60 $^{\circ}$ C (-40 $^{\circ}$ to 140 $^{\circ}$ F)
<b>Dimensions</b>	
Suction cup	13.5 cm OD
Height	17.0 cm
Weight	0.58 kg (1.28 lb)
<b>Materials</b>	
Suction cup and cushion pad	Silicone
Handle and support ring	Polyamide (nylon), glass fiber reinforced
Connection stem	Acetal polyoxymethylene
Support ring	Thermoplastic polyester elastomer
Metal parts	Stainless steel and brass
Battery	3.6 V primary lithium-thionyl chloride



### **ACCESSORIES AND REPLACEMENT COMPONENTS AVAILABLE FOR THE RESQCPR SYSTEM**

<b>Reorder #</b>	<b>Description</b>
12-0825-000	ResQCPR System (one ResQPUMP; two ResQPODs)
12-0822-000	ResQPOD ITD 16 (single device)
12-0823-000	ResQPUMP ACD-CPR Device (single device)
12-0586-000	Suction Cup for ACD-CPR Device (replacement suction cup with support ring and compression cushion)
12-0935-000	ResQCPR Carrying Case (holds one ResQPUMP and two ResQPODs)

## LIMITED WARRANTY

Subject to the terms, conditions and limitations contained herein, Advanced Circulatory warrants only to the ultimate user of the product that Advanced Circulatory's products will not fail to operate in accordance with their specifications due to defects in material or workmanship during the time period listed below. The foregoing period is sometimes referred to as the "original warranty period." The foregoing limited warranty does not apply to any part, portion, or component of any product which is manufactured by a third-party ("Third-Party Component"). The time period for the warranty begins on the date of delivery of the product to the first purchaser.

ResQPOD: Period ending on the earlier of the date of first use or the expiration date on the package for the product provided by Advanced Circulatory  
ResQPUMP: 12 months

THE LIMITED WARRANTY SET FORTH IN THE FOREGOING PARAGRAPH, IS THE SOLE AND EXCLUSIVE WARRANTY WITH RESPECT TO ADVANCED CIRCULATORY'S PRODUCTS. ADVANCED CIRCULATORY MAKES NO OTHER EXPRESS WARRANTY OF ANY KIND OR NATURE AS TO THE PRODUCTS OR THEIR PERFORMANCE EXCEPT FOR THOSE LIMITED WARRANTIES EXPRESSLY SET FORTH IN THE FOREGOING PARAGRAPH AND EXCEPT THEREFORE, SPECIFICALLY DISCLAIMS ANY AND ALL REPRESENTATIONS OR WARRANTIES OF ANY KIND OR NATURE CONCERNING THE PRODUCTS, INCLUDING, BUT NOT LIMITED TO, ANY REPRESENTATION OR WARRANTY THAT THE PRODUCTS COMPLY WITH ANY LAW, OR THAT ANY PARTICULAR RESULT WILL BE OBTAINED BY USING THE PRODUCTS. ADVANCED CIRCULATORY MAKES NO WARRANTIES WITH RESPECT TO ANY THIRD PARTY COMPONENT AND ADVANCED CIRCULATORY SPECIFICALLY SELLS SUCH THIRD-PARTY COMPONENTS "AS IS" WITHOUT ANY WARRANTY. FURTHER, ADVANCED CIRCULATORY MAKES NO IMPLIED WARRANTY OF ANY KIND OR NATURE WITH RESPECT TO ITS PRODUCTS OR ANY THIRD-PARTY COMPONENT AND SPECIFICALLY DISCLAIMS ANY AND ALL IMPLIED WARRANTIES, INCLUDING, BUT NOT LIMITED TO, ANY AND ALL IMPLIED WARRANTIES OF MERCHANTABILITY, FITNESS FOR A PARTICULAR PURPOSE, NON-INFRINGEMENT, OR COMPLIANCE WITH ANY FEDERAL, STATE OR LOCAL LAW, RULE OR REGULATION. IN ADDITION, ADVANCED CIRCULATORY EXPRESSLY DISCLAIMS TO THE FULLEST EXTENT ALLOWED BY LAW, RULE OR REGULATION ANY WARRANTY PROVIDED UNDER ANY LAW.

The limited warranties set forth above shall be null and void if (a) any alterations or modifications are made to a product, (b) a product is not maintained in strict compliance with the maintenance requirements set forth in the maintenance manual for such product or otherwise provided by Advanced Circulatory, (c) any repairs are made to a product which are not authorized by Advanced Circulatory in writing, (d) any failure of a product to comply with the above limited warranty is not reported to Advanced Circulatory in writing within thirty (30) days of the date such failure first occurs, (e) a product is operated after the failure of any warranty first occurs, (f) a product is used for any purpose other than for the purpose for which it was manufactured, (g) a product is not operated in strict compliance with the terms and conditions set forth in any operating manual, notice or other statement accompanying the product, (h) a product is abused or damaged, (i) purchaser fails to deliver the product to Advanced Circulatory for inspection and testing if requested by Advanced Circulatory or purchaser disposes of the product or any part or component on or before the thirtieth (30<sup>th</sup>) day after sending a written claim under the warranty to Advanced Circulatory, (j) such failure of the limited warranty results from a failure of any third party component, or (k) a product is not stored or handled as directed in writing by Advanced Circulatory.

The sole and exclusive remedy for any failure of any product to comply with the limited warranty set forth above or any other warranty imposed upon Advanced Circulatory by Law, if any, shall, at the election of Advanced Circulatory, in its sole discretion, be either (a) the repair or replacement of the product or component which failed to comply with such warranty or (b) the refund of the purchase price of the product. Except as provided below, any repair or replacement shall carry the same warranty as the original product but only for the remainder of the original warranty period. Purchaser's exclusive remedy with respect to any claim arising out of or as a result of third-party component shall be against the third-party manufacturer.

Any and all claims under the above limited warranty shall be made to Advanced Circulatory only in writing and not later than thirty (30) days after the date the product first fails to comply with the above limited warranty but in no event later than the expiration of the original warranty period with respect to which the claim is being made. Any claim under the above limited warranty made after such period for making a claim shall be null and void. After receiving written notice of the warranty claim, Advanced Circulatory shall determine whether to (a) repair or replace the product or part or (b) refund the purchase price of the product. Advanced Circulatory may require purchaser to return any Product or component thereof which purchaser claims to be defective to Advanced Circulatory at purchaser's cost for inspection as a condition to any claim under the above limited warranty. No product or part may be returned to Advanced Circulatory without Advanced Circulatory's prior written authorization. If a product which is returned is determined by Advanced Circulatory in its sole discretion not to have failed to comply with the limited warranty, purchaser shall pay costs of removal, repair and/or replacement for such product. If a product which is returned is determined by Advanced Circulatory in its sole discretion to have failed to comply with the limited warranty, Advanced Circulatory shall pay for all repair and/or replacement costs for such product (or refund the purchase price if so elected by Advanced Circulatory) and Advanced Circulatory shall reimburse purchaser for the reasonable costs of shipping the product or component to purchaser.

Manufactured by:

**Advanced Circulatory**

1905 County Road C West, Roseville, MN 55113 USA

Telephone: 651-403-5600

Customer service: 1-877-737-7763

Email: [info@advancedcirculatory.com](mailto:info@advancedcirculatory.com)

Website: [AdvancedCirculatory.com](http://AdvancedCirculatory.com)



17-0829-000, 07