

HIGHLIGHTS OF PRESCRIBING INFORMATION

These highlights do not include all the information needed to use PERFORMIST Inhalation Solution safely and effectively. See full prescribing information for PERFORMIST Inhalation Solution.

PERFORMIST® (formoterol fumarate) Inhalation Solution
Initial U.S. Approval: 2001

WARNING: ASTHMA-RELATED DEATH

See full prescribing information for complete boxed warning

- Long-acting beta₂-adrenergic agonists (LABA) increase the risk of asthma-related death. (5.1)
- A placebo-controlled study with another long-acting beta₂-adrenergic agonist (salmeterol) showed an increase in asthma-related deaths in patients receiving salmeterol. (5.1)
- The finding of an increased risk of asthma-related death with salmeterol is considered a class effect of LABA, including formoterol, the active ingredient in PERFORMIST. The safety and efficacy of PERFORMIST in patients with asthma have not been established. All LABA, including PERFORMIST, are contraindicated in patients with asthma without use of a long-term asthma control medication. (4, 5.1)

CONTRAINDICATIONS

- All LABA, including PERFORMIST, are contraindicated in patients with asthma without use of a long-term asthma control medication. (4)

WARNINGS AND PRECAUTIONS

- Do not initiate PERFORMIST Inhalation Solution in acutely deteriorating patients. (5.2)
- Do not use for relief of acute symptoms. Concomitant short-acting beta₂-agonists can be used as needed for acute relief. (5.2)
- Do not exceed the recommended dose. Excessive use of PERFORMIST Inhalation Solution, or use in conjunction with other medications containing long-acting beta₂-agonists, can result in clinically significant cardiovascular effects, and may be fatal. (5.3, 5.5)
- Life-threatening paradoxical bronchospasm can occur. Discontinue PERFORMIST Inhalation Solution immediately. (5.4)
- Use with caution in patients with cardiovascular or convulsive disorders, thyrotoxicosis, or with sensitivity to sympathomimetic drugs. (5.6, 5.7)

ADVERSE REACTIONS

Most common adverse reactions (≥2% and more common than placebo) are diarrhea, nausea, nasopharyngitis, dry mouth, vomiting, dizziness, and insomnia (6.2)

To report SUSPECTED ADVERSE REACTIONS, contact Dey Pharma, L.P. at 1-800-429-7751 or FDA at 1-800-FDA-1088 or www.fda.gov/medwatch.

DRUG INTERACTIONS

- Other adrenergic drugs may potentiate effect. Use with caution. (5.3, 7.1)
- Xanthine derivatives, steroids, diuretics, or non-potassium sparing diuretics may potentiate hypokalemia or ECG changes. Use with caution. (5.7, 7.2, 7.3)
- MAO inhibitors, tricyclic antidepressants and drugs that prolong QTc interval may potentiate effect on the cardiovascular system. Use with extreme caution. (7.4)
- Beta-blockers may decrease effectiveness. Use with caution and only when medically necessary. (7.5)

See 17 for PATIENT COUNSELING INFORMATION and FDA approved Medication Guide.

Revised: 05/2010

INDICATIONS AND USAGE

PERFORMIST Inhalation Solution is a long-acting beta₂-adrenergic agonist (beta₂-agonist) indicated for:

- Long-term, twice daily (morning and evening) administration in the maintenance treatment of bronchoconstriction in patients with chronic obstructive pulmonary disease (COPD), including chronic bronchitis and emphysema. (1.1)

Important limitations of use:

- PERFORMIST Inhalation Solution is not indicated to treat acute deteriorations of chronic obstructive pulmonary disease. (1.2, 5.2)
- PERFORMIST Inhalation Solution is not indicated to treat asthma. (1.2)

DOSAGE AND ADMINISTRATION

For oral inhalation only.

- One 20 mcg/2 mL vial every 12 hours (2)
- For use with a standard jet nebulizer (with a facemask or mouthpiece) connected to an air compressor (2)

DOSAGE FORMS AND STRENGTHS

Inhalation Solution (unit dose vial for nebulization); 20 mcg/2 mL solution (3)

FULL PRESCRIBING INFORMATION: CONTENTS*

1 INDICATIONS AND USAGE

- 1.1 Maintenance Treatment of COPD
- 1.2 Important Limitations of Use

2 DOSAGE AND ADMINISTRATION

3 DOSAGE FORMS AND STRENGTHS

4 CONTRAINDICATIONS

5 WARNINGS AND PRECAUTIONS

- 5.1 Asthma-Related Deaths
- 5.2 Deterioration of Disease and Acute Episodes
- 5.3 Excessive Use and Use with Other Long-Acting Beta₂-agonists
- 5.4 Paradoxical Bronchospasm
- 5.5 Cardiovascular Effects
- 5.6 Coexisting Conditions
- 5.7 Hypokalemia and Hyperglycemia

6 ADVERSE REACTIONS

- 6.1 Beta₂-agonist Adverse Reaction Profile
- 6.2 Clinical Trials Experience

7 DRUG INTERACTIONS

- 7.1 Adrenergic Drugs
- 7.2 Xanthine Derivatives, Steroids, or Diuretics
- 7.3 Non-potassium Sparing Diuretics

- 7.4 MAO Inhibitors, Tricyclic Antidepressants, QTc Prolonging Drugs
- 7.5 Beta-blockers

8 USE IN SPECIFIC POPULATIONS

- 8.1 Pregnancy
- 8.2 Labor and Delivery
- 8.3 Nursing Mothers
- 8.4 Pediatric Use
- 8.5 Geriatric Use

10 OVERDOSAGE

11 DESCRIPTION

12 CLINICAL PHARMACOLOGY

- 12.1 Mechanism of Action
- 12.2 Pharmacodynamics
- 12.3 Pharmacokinetics

13 NONCLINICAL TOXICOLOGY

- 13.1 Carcinogenesis, Mutagenesis, Impairment of Fertility
- 13.2 Animal Pharmacology

14 CLINICAL STUDIES

- 14.1 Adult COPD Trial

16 HOW SUPPLIED/STORAGE AND HANDLING

17 PATIENT COUNSELING INFORMATION

*Sections or subsections omitted from the full prescribing information are not listed.

FULL PRESCRIBING INFORMATION

WARNING:

ASTHMA-RELATED DEATH

Long-acting beta₂-adrenergic agonists (LABA) increase the risk of asthma-related death.

Data from a large placebo-controlled US study that compared the safety of another long-acting beta₂-adrenergic agonist (salmeterol) or placebo added to usual asthma therapy showed an increase in asthma-related deaths in patients receiving salmeterol. This finding with salmeterol is considered a class effect of LABA, including formoterol, the active ingredient in PERFOROMIST Inhalation Solution. The safety and efficacy of PERFOROMIST in patients with asthma have not been established. All LABA, including PERFOROMIST, are contraindicated in patients with asthma without use of a long-term asthma control medication [see CONTRAINDICATIONS (4), WARNINGS AND PRECAUTIONS (5.1)].

1 INDICATIONS AND USAGE

1.1 Maintenance Treatment of COPD

PERFOROMIST (formoterol fumarate)

Inhalation Solution is indicated for the long-term, twice daily (morning and evening) administration in the maintenance treatment of bronchoconstriction in patients with chronic obstructive pulmonary disease (COPD), including chronic bronchitis and emphysema.

1.2 Important Limitations of Use

PERFOROMIST Inhalation Solution is not indicated to treat acute deteriorations of chronic obstructive pulmonary disease [see WARNINGS AND PRECAUTIONS (5.2)].

PERFOROMIST Inhalation Solution is not indicated to treat asthma. The safety and effectiveness of PERFOROMIST Inhalation Solution in asthma have not been established.

2 DOSAGE AND ADMINISTRATION

The recommended dose of PERFOROMIST (formoterol fumarate) Inhalation Solution is one 20 mcg unit-dose vial administered twice daily (morning and evening) by nebulization. A total daily dose greater than 40 mcg is not recommended.

PERFOROMIST Inhalation Solution should be administered by the orally inhaled route via a standard jet nebulizer connected to an air compressor. The safety and efficacy of PERFOROMIST Inhalation Solution have been established in clinical trials when administered using the PARI-LC Plus[®] nebulizer (with a facemask or mouthpiece) and the

PRONEB[®] Ultra compressor. The safety and efficacy of PERFOROMIST Inhalation Solution delivered from non-compressor based nebulizer systems have not been established.

PERFOROMIST Inhalation Solution should always be stored in the foil pouch, and only removed IMMEDIATELY BEFORE USE. Contents of any partially used container should be discarded.

If the recommended maintenance treatment regimen fails to provide the usual response, medical advice should be sought immediately, as this is often a sign of destabilization of COPD. Under these circumstances, the therapeutic regimen should be re-evaluated and additional therapeutic options should be considered.

The drug compatibility (physical and chemical), efficacy, and safety of PERFOROMIST Inhalation Solution when mixed with other drugs in a nebulizer have not been established.

3 DOSAGE FORMS AND STRENGTHS

PERFOROMIST (formoterol fumarate)

Inhalation Solution is supplied as a sterile solution for nebulization in low-density polyethylene unit-dose vials. Each vial contains formoterol fumarate dihydrate equivalent to 20 mcg/2 mL of formoterol fumarate.

4 CONTRAINDICATIONS

All LABA, including PERFOROMIST, are contraindicated in patients with asthma without use of a long-term asthma control medication. [See WARNINGS and PRECAUTIONS (5.1)]

5 WARNINGS AND PRECAUTIONS

5.1 Asthma-Related Deaths [See BOXED WARNING]

Data from a large placebo-controlled study in asthma patients showed that long-acting beta₂-adrenergic agonists may increase the risk of asthma-related death. Data are not available to determine whether the rate of death in patients with COPD is increased by long-acting beta₂-adrenergic agonists.

A 28-week, placebo-controlled US study comparing the safety of salmeterol with placebo, each added to usual asthma therapy, showed an increase in asthma-related deaths in patients receiving salmeterol (13/13,176 in patients treated with salmeterol vs. 3/13,179 in patients treated with placebo; RR 4.37, 95% CI 1.25, 15.34). The increased risk of asthma-related death is considered a class effect of the long-acting beta₂-adrenergic agonists, including PERFOROMIST Inhalation Solution. No study adequate to determine whether the rate of asthma related death is increased in patients treated with PERFOROMIST Inhalation

Solution has been conducted. The safety and efficacy of PERFOROMIST in patients with asthma have not been established. All LABA, including PERFOROMIST, are contraindicated in patients with asthma without use of a long-term asthma control medication. [See *CONTRAINDICATIONS (4)*]

Clinical studies with formoterol fumarate administered as a dry powder inhaler suggested a higher incidence of serious asthma exacerbations in patients who received formoterol than in those who received placebo. The sizes of these studies were not adequate to precisely quantify the differences in serious asthma exacerbation rates between treatment groups.

5.2 Deterioration of Disease and Acute Episodes

PERFOROMIST Inhalation Solution should not be initiated in patients with acutely deteriorating COPD, which may be a life-threatening condition. PERFOROMIST Inhalation Solution has not been studied in patients with acutely deteriorating COPD. The use of PERFOROMIST Inhalation Solution in this setting is inappropriate.

PERFOROMIST Inhalation Solution should not be used for the relief of acute symptoms, i.e., as rescue therapy for the treatment of acute episodes of bronchospasm. PERFOROMIST Inhalation Solution has not been studied in the relief of acute symptoms and extra doses should not be used for that purpose. Acute symptoms should be treated with an inhaled short-acting beta₂-agonist.

When beginning PERFOROMIST Inhalation Solution, patients who have been taking inhaled, short-acting beta₂-agonists on a regular basis (e.g., four times a day) should be instructed to discontinue the regular use of these drugs and use them only for symptomatic relief of acute respiratory symptoms. When prescribing PERFOROMIST Inhalation Solution, the healthcare provider should also prescribe an inhaled, short-acting beta₂-agonist and instruct the patient how it should be used. Increasing inhaled beta₂-agonist use is a signal of deteriorating disease for which prompt medical attention is indicated. COPD may deteriorate acutely over a period of hours or chronically over several days or longer. If PERFOROMIST Inhalation Solution no longer controls the symptoms of bronchoconstriction, or the patient's inhaled, short-acting beta₂-agonist becomes less effective or the patient needs more inhalation of short-acting beta₂-agonist than usual, these may be markers of deterioration of disease. In this setting, a re-evaluation of the patient and the COPD treatment regimen should be undertaken at once. Increasing the daily dosage of PERFOROMIST Inhalation Solution

beyond the recommended 20 mcg twice daily dose is not appropriate in this situation.

5.3 Excessive Use of PERFOROMIST Inhalation Solution and Use with Other Long-Acting Beta₂-Agonists

As with other inhaled beta₂-adrenergic drugs, PERFOROMIST Inhalation Solution should not be used more often, at higher doses than recommended, or in conjunction with other medications containing long-acting beta₂-agonists, as an overdose may result. Clinically significant cardiovascular effects and fatalities have been reported in association with excessive use of inhaled sympathomimetic drugs.

5.4 Paradoxical Bronchospasm

As with other inhaled beta₂-agonists, PERFOROMIST Inhalation Solution can produce paradoxical bronchospasm that may be life-threatening. If paradoxical bronchospasm occurs, PERFOROMIST Inhalation Solution should be discontinued immediately and alternative therapy instituted.

5.5 Cardiovascular Effects

PERFOROMIST Inhalation Solution, like other beta₂-agonists, can produce a clinically significant cardiovascular effect in some patients as measured by increases in pulse rate, systolic and/or diastolic blood pressure, and/or symptoms. If such effects occur, PERFOROMIST Inhalation Solution may need to be discontinued. In addition, beta-agonists have been reported to produce ECG changes, such as flattening of the T wave, prolongation of the QTc interval, and ST segment depression. The clinical significance of these findings is unknown. Therefore, PERFOROMIST Inhalation Solution, like other sympathomimetic amines, should be used with caution in patients with cardiovascular disorders, especially coronary insufficiency, cardiac arrhythmias, and hypertension.

5.6 Coexisting Conditions

PERFOROMIST Inhalation Solution, like other sympathomimetic amines, should be used with caution in patients with convulsive disorders or thyrotoxicosis, and in patients who are unusually responsive to sympathomimetic amines. Doses of the related beta₂-agonist albuterol, when administered intravenously, have been reported to aggravate preexisting diabetes mellitus and ketoacidosis.

5.7 Hypokalemia and Hyperglycemia

Beta-agonist medications may produce significant hypokalemia in some patients, possibly through intracellular shunting, which has the potential to produce adverse cardiovascular effects [see *CLINICAL PHARMACOLOGY (12.2)*]. The decrease in serum potassium is usually transient, not requiring supplementation. Beta-agonist medications

may produce transient hyperglycemia in some patients.

Clinically significant changes in serum potassium and blood glucose were infrequent during clinical studies with long-term administration of PERFORMIST Inhalation Solution at the recommended dose.

6 ADVERSE REACTIONS

Long acting beta₂-adrenergic agonists such as formoterol increase the risk of asthma-related death [See BOXED WARNING and WARNINGS AND PRECAUTIONS (5.1)].

6.1 Beta₂-Agonist Adverse Reaction Profile

Adverse reactions to PERFORMIST Inhalation Solution are expected to be similar in nature to other beta₂-adrenergic receptor agonists including: angina, hypertension or hypotension, tachycardia, arrhythmias, nervousness, headache, tremor, dry mouth, muscle cramps, palpitations, nausea, dizziness, fatigue, malaise, insomnia, hypokalemia, hyperglycemia, and metabolic acidosis.

6.2 Clinical Trials Experience

Because clinical trials are conducted under widely varying conditions, adverse reaction rates observed in the clinical trials of a drug cannot be directly compared to rates in the clinical trials of another drug and may not reflect the rates observed in practice.

Adults with COPD

The data described below reflect exposure to PERFORMIST Inhalation Solution 20 mcg twice daily by oral inhalation in 586 patients, including 232 exposed for 6 months and 155 exposed for at least 1 year. PERFORMIST Inhalation Solution was studied in a 12-week, placebo- and active-controlled trial (123 subjects treated with PERFORMIST Inhalation Solution) and a 52-week, active-controlled trial (463 subjects treated with PERFORMIST Inhalation Solution). Patients were mostly Caucasians (88%) between 40-90 years old (mean, 64 years old) and had COPD, with a mean FEV₁ of 1.33 L. Patients with significant concurrent cardiac and other medical diseases were excluded from the trials.

Table 1 shows adverse reactions from the 12-week, double-blind, placebo-controlled trial where the frequency was greater than or equal to 2% in the PERFORMIST Inhalation Solution group and where the rate in the PERFORMIST Inhalation Solution group exceeded the rate in the placebo group. In this trial, the frequency of patients experiencing cardiovascular adverse events was 4.1% for PERFORMIST Inhalation Solution and 4.4% for placebo. There were no frequently occurring specific cardiovascular adverse events for PERFORMIST Inhalation Solution (frequency

greater than or equal to 1% and greater than placebo). The rate of COPD exacerbations was 4.1% for PERFORMIST Inhalation Solution and 7.9% for placebo.

Adverse Reaction	PERFORMIST Inhalation Solution 20 mcg		Placebo	
	n	(%)	n	(%)
Total Patients	123	(100)	114	(100)
Diarrhea	6	(4.9)	4	(3.5)
Nausea	6	(4.9)	3	(2.6)
Nasopharyngitis	4	(3.3)	2	(1.8)
Dry Mouth	4	(3.3)	2	(1.8)
Vomiting	3	(2.4)	2	(1.8)
Dizziness	3	(2.4)	1	(0.9)
Insomnia	3	(2.4)	0	0

Patients treated with PERFORMIST Inhalation Solution 20 mcg twice daily in the 52-week open-label trial did not experience an increase in specific clinically significant adverse events above the number expected based on the medical condition and age of the patients.

7 DRUG INTERACTIONS

7.1 Adrenergic Drugs

If additional adrenergic drugs are to be administered by any route, they should be used with caution because the sympathetic effects of formoterol may be potentiated [see WARNINGS AND PRECAUTIONS (5.3, 5.5, 5.6, 5.7)].

7.2 Xanthine Derivatives, Steroids, or Diuretics

Concomitant treatment with xanthine derivatives, steroids, or diuretics may potentiate any hypokalemic effect of adrenergic agonists [see WARNINGS AND PRECAUTIONS (5.7)].

7.3 Non-potassium Sparing Diuretics

The ECG changes and/or hypokalemia that may result from the administration of non-potassium sparing diuretics (such as loop or thiazide diuretics) can be acutely worsened by beta-agonists, especially when the recommended dose of the beta-agonist is exceeded. Although the clinical significance of these effects is not known, caution is advised in the co-administration of beta-agonists with non-potassium sparing diuretics.

7.4 MAO Inhibitors, Tricyclic Antidepressants, QTc Prolonging Drugs

Formoterol, as with other beta₂-agonists, should be administered with extreme caution to patients being treated with monoamine oxidase

inhibitors, tricyclic antidepressants, or drugs known to prolong the QTc interval because the effect of adrenergic agonists on the cardiovascular system may be potentiated by these agents. Drugs that are known to prolong the QTc interval have an increased risk of ventricular arrhythmias.

7.5 Beta-blockers

Beta-adrenergic receptor antagonists (beta-blockers) and formoterol may inhibit the effect of each other when administered concurrently. Beta-blockers not only block the therapeutic effects of beta-agonists, but may produce severe bronchospasm in COPD patients. Therefore, patients with COPD should not normally be treated with beta-blockers. However, under certain circumstances, e.g., as prophylaxis after myocardial infarction, there may be no acceptable alternatives to the use of beta-blockers in patients with COPD. In this setting, cardioselective beta-blockers could be considered, although they should be administered with caution.

8 USE IN SPECIFIC POPULATIONS

8.1 Pregnancy

Teratogenic Effects: Pregnancy Category C

Formoterol fumarate administered throughout organogenesis did not cause malformations in rats or rabbits following oral administration. However, formoterol fumarate was found to be teratogenic in rats and rabbits in other testing laboratories. When given to rats throughout organogenesis, oral doses of 0.2 mg/kg (approximately 40 times the maximum recommended daily inhalation dose in humans on a mg/m² basis) and above delayed ossification of the fetus, and doses of 6 mg/kg (approximately 1200 times the maximum recommended daily inhalation dose in humans on a mg/m² basis) and above decreased fetal weight. Formoterol fumarate has been shown to cause stillbirth and neonatal mortality at oral doses of 6 mg/kg and above in rats receiving the drug during the late stage of pregnancy. These effects, however, were not produced at a dose of 0.2 mg/kg. Because there are no adequate and well-controlled studies in pregnant women, PERFOROMIST Inhalation Solution should be used during pregnancy only if the potential benefit justifies the potential risk to the fetus.

Women should be advised to contact their physician if they become pregnant while taking PERFOROMIST Inhalation Solution.

8.2 Labor and Delivery

There are no adequate and well-controlled human studies that have investigated the effects of PERFOROMIST Inhalation Solution during labor and delivery.

Because beta-agonists may potentially interfere with uterine contractility, PERFOROMIST Inhalation Solution should be used during labor only if the potential benefit justifies the potential risk.

8.3 Nursing Mothers

In reproductive studies in rats, formoterol was excreted in the milk. It is not known whether formoterol is excreted in human milk, but because many drugs are excreted in human milk, caution should be exercised if PERFOROMIST Inhalation Solution is administered to nursing women. There are no well-controlled human studies of the use of PERFOROMIST Inhalation Solution in nursing mothers.

Women should be advised to contact their physician if they are nursing while taking PERFOROMIST Inhalation Solution.

8.4 Pediatric Use

PERFOROMIST Inhalation Solution is not indicated for use in children. The safety and effectiveness of PERFOROMIST Inhalation Solution in pediatric patients have not been established. The pharmacokinetics of formoterol fumarate has not been studied in pediatric patients.

8.5 Geriatric Use

Of the 586 subjects who received PERFOROMIST Inhalation Solution in clinical studies, 284 were 65 years and over, while 89 were 75 years and over. Of the 123 subjects who received PERFOROMIST Inhalation Solution in the 12-week safety and efficacy trial, 48 (39%) were 65 years of age or older. No overall differences in safety or effectiveness were observed between these subjects and younger subjects. Other reported clinical experience has not identified differences in responses between the elderly and younger adult patients, but greater sensitivity of some older individuals cannot be ruled out.

The pharmacokinetics of PERFOROMIST Inhalation Solution has not been studied in elderly subjects.

10 OVERDOSAGE

The expected signs and symptoms with overdosage of PERFOROMIST Inhalation Solution are those of excessive beta-adrenergic stimulation and/or occurrence or exaggeration of any of the signs and symptoms listed under ADVERSE REACTIONS. Signs and symptoms may include angina, hypertension or hypotension, tachycardia with rates up to 200 beats/min, arrhythmias, nervousness, headache, tremor, seizures, muscle cramps, dry mouth, palpitation, nausea, dizziness, fatigue, malaise, insomnia, hyperglycemia, hypokalemia, and metabolic acidosis. As with all inhaled sympathomimetic medications, cardiac arrest

and even death may be associated with an overdose of PERFOROMIST Inhalation Solution.

Treatment of overdosage consists of discontinuation of PERFOROMIST Inhalation Solution together with institution of appropriate symptomatic and/or supportive therapy. The judicious use of a cardioselective beta-receptor blocker may be considered, bearing in mind that such medication can produce bronchospasm. There is insufficient evidence to determine if dialysis is beneficial for overdosage of PERFOROMIST Inhalation Solution. Cardiac monitoring is recommended in cases of overdosage.

The minimum lethal inhalation dose of formoterol fumarate in rats is 156 mg/kg (approximately 32,000 times the maximum recommended daily inhalation dose in humans on a mg/m² basis). The median lethal oral doses in Chinese hamsters, rats, and mice provide even higher multiples of the maximum recommended daily inhalation dose in humans.

For additional information about overdose treatment, call a poison control center (1-800-222-1222).

11 DESCRIPTION

PERFOROMIST (formoterol fumarate) Inhalation Solution is supplied as 2 mL of formoterol fumarate inhalation solution packaged in a 2.5 mL single-use low-density polyethylene vial and overwrapped in a foil pouch. Each vial contains 2 mL of a clear, colorless solution composed of formoterol fumarate dihydrate equivalent to 20 mcg of formoterol fumarate in an isotonic, sterile aqueous solution containing sodium chloride, pH adjusted to 5.0 with citric acid and sodium citrate.

The active component of PERFOROMIST Inhalation Solution is formoterol fumarate dihydrate, a racemate. Formoterol fumarate dihydrate is a beta₂-adrenergic bronchodilator. Its chemical name is (±)-2-hydroxy-5-[(1RS)-1-hydroxy-2-[[[(1RS)-2-(4-methoxyphenyl)-1-methylethyl]-amino]ethyl]formanilide fumarate dihydrate; its structural formula is:

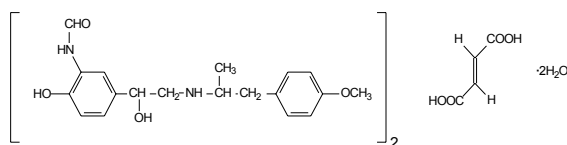

Formoterol fumarate dihydrate has a molecular weight of 840.92 and its empirical formula is (C₁₉H₂₄N₂O₄)₂•C₄H₄O₄•2H₂O. Formoterol fumarate dihydrate is a white to yellowish crystalline powder, which is freely soluble in glacial acetic acid, soluble in methanol, sparingly soluble in ethanol and

isopropanol, slightly soluble in water, and practically insoluble in acetone, ethyl acetate, and diethyl ether.

PERFOROMIST Inhalation Solution does not require dilution prior to administration by nebulization. Like all other nebulized treatments, the amount delivered to the lungs will depend on patient factors and the nebulization system used and its performance.

Using the PARI-LC Plus[®] nebulizer (with a facemask or mouthpiece) connected to a PRONEB[®] Ultra compressor under in vitro conditions, the mean delivered dose from the mouthpiece was approximately 7.3 mcg (37% of label claim). The mean nebulizer flow rate was 4 LPM and the nebulization time was 9 minutes. PERFOROMIST Inhalation Solution should be administered from a standard jet nebulizer at adequate flow rates via a facemask or mouthpiece.

12 CLINICAL PHARMACOLOGY

12.1 Mechanism of Action

Formoterol fumarate is a long-acting, beta₂-adrenergic receptor agonist (beta₂-agonist). Inhaled formoterol fumarate acts locally in the lung as a bronchodilator. In vitro studies have shown that formoterol has more than 200-fold greater agonist activity at beta₂-receptors than at beta₁-receptors. Although beta₂-receptors are the predominant adrenergic receptors in bronchial smooth muscle and beta₁-receptors are the predominant receptors in the heart, there are also beta₂-receptors in the human heart comprising 10% to 50% of the total beta-adrenergic receptors. The precise function of these receptors has not been established, but they raise the possibility that even highly selective beta₂-agonists may have cardiac effects.

The pharmacologic effects of beta₂-adrenoceptor agonist drugs, including formoterol, are at least in part attributable to stimulation of intracellular adenylyl cyclase, the enzyme that catalyzes the conversion of adenosine triphosphate (ATP) to cyclic-3', 5'-adenosine monophosphate (cyclic AMP). Increased cyclic AMP levels cause relaxation of bronchial smooth muscle and inhibition of release of mediators of immediate hypersensitivity from cells, especially from mast cells.

In vitro tests show that formoterol is an inhibitor of the release of mast cell mediators, such as histamine and leukotrienes, from the human lung. Formoterol also inhibits histamine-induced plasma albumin extravasation in anesthetized guinea pigs and inhibits allergen-induced eosinophil influx in dogs with airway hyper-responsiveness. The relevance of these in vitro and animal findings to humans with COPD is unknown.

12.2 Pharmacodynamics

Systemic Safety and Pharmacokinetic /
Pharmacodynamic Relationships

The major adverse effects of inhaled beta₂-agonists occur as a result of excessive activation of the systemic beta-adrenergic receptors. The most common adverse effects in adults include skeletal muscle tremor and cramps, insomnia, tachycardia, decreases in plasma potassium, and increases in plasma glucose.

Changes in serum potassium and serum glucose were evaluated in 12 COPD patients following inhalation of single doses of PERFOROMIST Inhalation Solution containing 10, 20 and 244 mcg of formoterol fumarate (calculated on an anhydrous basis) in a crossover study. At 1 hour after treatment with formoterol fumarate inhalation solution, mean (\pm standard deviation) serum glucose rose 26 ± 30 , 29 ± 28 , and 38 ± 44 mg/dL, respectively, and was not significantly different from baseline or trough level at 24 hours post-dose. At 1 hour after dosing with formoterol fumarate inhalation solution 244 mcg, serum potassium fell by 0.68 ± 0.4 mEq/L, and was not different from baseline or trough level at 24 hours post-dose.

Linear pharmacokinetic/pharmacodynamic (PK/PD) relationships between urinary formoterol excretion and decreases in serum potassium, increases in plasma glucose, and increases in heart rate were generally observed with another inhalation formulation of formoterol fumarate and hence would be expected with PERFOROMIST Inhalation Solution also. Following single dose administration of 10-fold the recommended clinical dose of the other formoterol fumarate inhalation formulation having comparable exposure to single dose of 244 mcg of PERFOROMIST Inhalation Solution (approximately 12-fold the recommended clinical dose) in healthy subjects, the formoterol plasma concentration was found to be highly correlated with the reduction in plasma potassium concentration. Data from this study showed that maximum reductions from baseline in plasma potassium ranged from 0.55 to 1.52 mmol/L with a median maximum reduction of 1.01 mmol/L. Generally, the maximum effect on plasma potassium was noted 1 to 3 hours after peak formoterol plasma concentrations were achieved.

Electrophysiology

In the dose-ranging study of PERFOROMIST Inhalation Solution, ECG-determined heart rate increased by a mean of 6 ± 3 beats per minute at 6 hours after a single dose of 244 mcg, but was back to predose level at 16-24 hours.

The effect of PERFOROMIST Inhalation Solution on heart rate and cardiac rhythm was studied in a 12-week clinical trial comparing

PERFOROMIST Inhalation Solution to placebo and an active control treatment. COPD patients, including 105 patients exposed to PERFOROMIST Inhalation Solution, underwent continuous electrocardiographic (Holter) monitoring during two 24-hour periods (study baseline and after 8-12 weeks of treatment). ECGs were performed pre-dose and at 2 to 3 hours post-dose at study baseline (prior to dosing) and after 4, 8 and 12 weeks of treatment. Bazett's and Fridericia's methods were used to correct the QT interval for heart rate (QTcB and QTcF, respectively). The mean increase from baseline in QTcB interval over the 12-week treatment period was ≤ 4.8 msec for PERFOROMIST Inhalation Solution and ≤ 4.6 msec for placebo. The percent of patients who experienced a maximum change in QTc greater than 60 msec at any time during the 12-week treatment period was 0% and 1.8% for PERFOROMIST Inhalation Solution and placebo, respectively, based on Bazett's correction, and 1.6% and 0.9%, respectively, based on Fridericia's correction. Prolonged QT was reported as an adverse event in 1 (0.8%) patient treated with PERFOROMIST Inhalation Solution and 2 (1.8%) placebo patients. No occurrences of atrial fibrillation or ventricular tachycardia were observed during 24-hour Holter monitoring or reported as adverse events in patients treated with PERFOROMIST Inhalation Solution after the start of dosing. No increase in supraventricular tachycardia over placebo-treated subjects was observed. The mean increase in maximum heart rate from baseline to 8-12 weeks after the start of dosing was 0.6 beats per minute (bpm) for patients treated with PERFOROMIST Inhalation Solution twice daily compared to 1.2 bpm for placebo patients. There were no clinically meaningful differences from placebo in acute or chronic effects on heart rate, including QTcB and QTcF, or cardiac rhythm resulting from treatment with PERFOROMIST Inhalation Solution.

At an exposure from formoterol fumarate dry powder formulation comparable to approximately 12-fold the recommended dose of PERFOROMIST Inhalation Solution, a mean maximum increase of pulse rate of 26 bpm was observed 6 hours post dose in healthy subjects. This study showed that the maximum increase of mean corrected QT interval (QTc) was 25 msec when calculated using Bazett's correction and was 8 msec when calculated using Fridericia's correction. The QTc returned to baseline within 12 to 24 hours post-dose. Formoterol plasma concentrations were weakly correlated with pulse rate and increase of QTc duration. The effects on pulse rate and QTc interval are known pharmacological effects of this class of study drug and were not

unexpected at this supratherapeutic formoterol fumarate inhalation dose.

Tachyphylaxis / Tolerance

Tolerance to the effects of inhaled beta-agonists can occur with regularly-scheduled, chronic use. In a placebo-controlled clinical trial in 351 adult patients with COPD, the bronchodilating effect of PERFOROMIST Inhalation Solution was determined by the FEV₁ area under the curve over 12 hours following dosing on Day 1 and after 12 weeks of treatment. The effect of PERFOROMIST Inhalation Solution did not decrease after 12 weeks of twice-daily treatment (Figures 1 and 2).

12.3 Pharmacokinetics

Information on the pharmacokinetics of formoterol (dry powder and/or inhalation solution) in plasma and/or urine is available in healthy subjects as well as patients with chronic obstructive pulmonary disease after oral inhalation of doses at and above the therapeutic dose.

Urinary excretion of unchanged formoterol was used as an indirect measure of systemic exposure. Plasma drug disposition data parallel urinary excretion, and the elimination half-lives calculated for urine and plasma are similar.

Absorption

Pharmacokinetic properties of formoterol fumarate were evaluated in 12 COPD patients following inhalation of single doses of PERFOROMIST Inhalation Solution containing 10, 20 and 244 mcg of formoterol fumarate (calculated on an anhydrous basis) and 12 mcg formoterol fumarate dry powder, through 36 hours after single-dose administration. Formoterol fumarate concentrations in plasma following the 10 and 20 mcg doses of PERFOROMIST Inhalation Solution and the 12 mcg dose of formoterol fumarate dry powder were undetectable or only detected sporadically at very low concentrations. Following a single 244 mcg dose of PERFOROMIST Inhalation Solution (approximately 12 times the recommended clinical dose), formoterol fumarate concentrations were readily measurable in plasma, exhibiting rapid absorption into plasma, and reaching a maximum drug concentration of 72 pg/mL within approximately 12 minutes of dosing.

The mean amount of formoterol excreted unchanged in 24 hour urine following single oral inhalation doses of 10, 20, and 244 mcg PERFOROMIST Inhalation Solution were found to be 109.7 ng, 349.6 ng, and 3317.5 ng, respectively. These findings indicate a near dose proportional increase in systemic exposure within the dose range tested.

When 12 mcg of a dry powder formulation of formoterol fumarate was given twice daily to

COPD patients by oral inhalation for 12 weeks, the accumulation index, based on the urinary excretion of unchanged formoterol was 1.19 to 1.38. This suggests some accumulation of formoterol in plasma with multiple dosing. Although multiple-dose pharmacokinetic data is unavailable from PERFOROMIST Inhalation Solution, assumption of linear pharmacokinetics allows a reasonable prediction of minimal accumulation based on single-dose pharmacokinetics. As with many drug products for oral inhalation, it is likely that the majority of the inhaled formoterol fumarate delivered is swallowed and then absorbed from the gastrointestinal tract.

Distribution

The binding of formoterol to human plasma proteins *in vitro* was 61% to 64% at concentrations from 0.1 to 100 ng/mL. Binding to human serum albumin *in vitro* was 31% to 38% over a range of 5 to 500 ng/mL. The concentrations of formoterol used to assess the plasma protein binding were higher than those achieved in plasma following inhalation of a single 244 mcg dose of PERFOROMIST Inhalation Solution.

Metabolism

Formoterol is metabolized primarily by direct glucuronidation at either the phenolic or aliphatic hydroxyl group and O-demethylation followed by glucuronide conjugation at either phenolic hydroxyl groups. Minor pathways involve sulfate conjugation of formoterol and deformylation followed by sulfate conjugation. The most prominent pathway involves direct conjugation at the phenolic hydroxyl group. The second major pathway involves O-demethylation followed by conjugation at the phenolic 2'-hydroxyl group. *In vitro* studies showed that multiple drug-metabolizing enzymes catalyze glucuronidation (UGT1A1, 1A8, 1A9, 2B7 and 2B15 were the most predominant enzymes) and O-demethylation (CYP2D6, CYP2C19, CYP2C9 and CYP2A6) of formoterol. Formoterol did not inhibit CYP450 enzymes at therapeutically relevant concentrations. Some patients may be deficient in CYP2D6 or 2C19 or both. Whether a deficiency in one or both of these isozymes results in elevated systemic exposure to formoterol or systemic adverse effects has not been adequately explored.

Excretion

Following administration of single 10, 20, and 244 mcg PERFOROMIST Inhalation Solution doses (calculated on an anhydrous basis) delivered via nebulizer in 12 COPD patients, on average, about 1.1% to 1.7% of the dose was excreted in the urine as unchanged formoterol as compared to about 3.4% excreted unchanged following inhalation administration of 12 mcg of formoterol fumarate dry powder. Renal clearance of formoterol following

inhalation administration of PERFOROMIST Inhalation Solution in these subjects was about 157 mL/min. Based on plasma concentrations measured following the 244 mcg dose, the mean terminal elimination half-life was determined to be 7 hours.

Gender

As reported for another formoterol fumarate inhalation formulation, upon correction for body weight, pharmacokinetics of formoterol fumarate did not differ significantly between males and females.

Geriatric, Pediatric, Hepatic/Renal Impairment

The pharmacokinetics of formoterol fumarate has not been studied in elderly and pediatric patient populations. The pharmacokinetics of formoterol fumarate has not been studied in subjects with hepatic or renal impairment.

13 NONCLINICAL TOXICOLOGY

13.1 Carcinogenesis, Mutagenesis, Impairment of Fertility

The carcinogenic potential of formoterol fumarate has been evaluated in 2-year drinking water and dietary studies in both rats and mice. In rats, the incidence of ovarian leiomyomas was increased at doses of 15 mg/kg and above in the drinking water study and at 20 mg/kg in the dietary study (AUC exposure approximately 2300 times human exposure at the maximum recommended daily inhalation dose), but not at dietary doses up to 5 mg/kg (AUC exposure approximately 570 times human exposure at the maximum recommended daily inhalation dose). In the dietary study, the incidence of benign ovarian theca-cell tumors was increased at doses of 0.5 mg/kg (AUC exposure was approximately 57 times human exposure at the maximum recommended daily inhalation dose) and above. This finding was not observed in the drinking water study, nor was it seen in mice (see below).

In mice, the incidence of adrenal subcapsular adenomas and carcinomas was increased in males at doses of 69 mg/kg (AUC exposure approximately 1000 times human exposure at the maximum recommended daily inhalation dose) and above in the drinking water study, but not at doses up to 50 mg/kg (AUC exposure approximately 750 times human exposure at the maximum recommended daily inhalation dose) in the dietary study. The incidence of hepatocarcinomas was increased in the dietary study at doses of 20 and 50 mg/kg in females (AUC exposures approximately 300 and 750 times human exposure at the maximum recommended daily inhalation dose, respectively) and 50 mg/kg in males, but not at doses up to 5 mg/kg (AUC exposure approximately 75 times human exposure at the maximum recommended daily inhalation dose). Also in the dietary study, the incidence of uterine

leiomyomas and leiomyosarcomas was increased at doses of 2 mg/kg (AUC exposure was approximately 30 times human exposure at the maximum recommended daily inhalation dose) and above. Increases in leiomyomas of the rodent female genital tract have been similarly demonstrated with other beta-agonist drugs.

Formoterol fumarate was not mutagenic or clastogenic in the following tests: mutagenicity tests in bacterial and mammalian cells, chromosomal analyses in mammalian cells, unscheduled DNA synthesis repair tests in rat hepatocytes and human fibroblasts, transformation assay in mammalian fibroblasts and micronucleus tests in mice and rats.

Reproduction studies in rats revealed no impairment of fertility at oral doses up to 3 mg/kg (approximately 600 times the maximum recommended daily inhalation powder dose in humans on a mg/m² basis).

13.2 Animal Pharmacology

Studies in laboratory animals (minipigs, rodents, and dogs) have demonstrated the occurrence of cardiac arrhythmias and sudden death (with histologic evidence of myocardial necrosis) when beta-agonists and methylxanthines are administered concurrently. The clinical significance of these findings is unknown. [See DRUG INTERACTIONS, Xanthine Derivatives, Steroids, or Diuretics (7.2)]

14 CLINICAL STUDIES

14.1 Adult COPD Trial

PERFOROMIST (formoterol fumarate) Inhalation Solution was evaluated in a 12-week, double-blind, placebo- and active-controlled, randomized, parallel-group, multicenter trial conducted in the United States. Of a total enrollment of 351 adults (age range: 40 to 86 years; mean age: 63 years) with COPD who had a mean pre-bronchodilator FEV₁ of 1.34 liters (44% of predicted), 237 patients were randomized to PERFOROMIST Inhalation Solution 20 mcg or placebo, administered twice daily via a PARI-LC Plus[®] nebulizer with a PRONEB[®] Ultra compressor. The diagnosis of COPD was based upon a prior clinical diagnosis of COPD, a smoking history (at least 10 pack-years), age (at least 40 years), and spirometry results (pre-bronchodilator baseline FEV₁ at least 30% and less than 70% of the predicted value, and the FEV₁/FVC less than 70%). About 58% of patients had bronchodilator reversibility, defined as a 10% or greater increase in FEV₁ after inhalation of 2 actuations (180 mcg) of albuterol from a metered dose inhaler. About 86% (106) of patients treated with PERFOROMIST Inhalation Solution and 74% (84) of placebo patients completed the trial.

PERFOROMIST Inhalation Solution 20 mcg twice daily resulted in significantly greater post-dose bronchodilation (as measured by serial FEV₁ for 12 hours post-dose; the primary efficacy analysis) compared to placebo when evaluated at endpoint (week 12 for completers and last observation for dropouts). Similar results were seen on Day 1 and at subsequent timepoints during the trial.

Mean FEV₁ measurements at Day 1 (Figure 1) and at endpoint (Figure 2) are shown below.

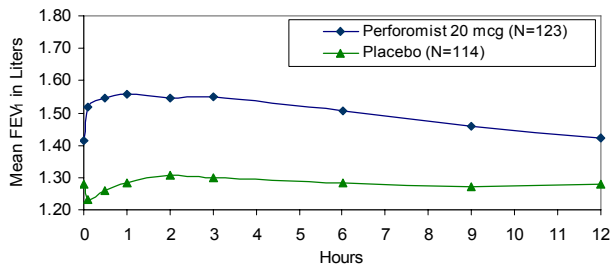
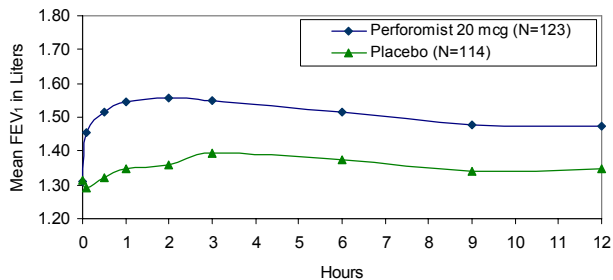

Patients treated with PERFOROMIST Inhalation Solution used less rescue albuterol during the trial compared to patients treated with placebo.

Examination of age (≥ 65 or younger) and gender subgroups did not identify differences in response to PERFOROMIST Inhalation Solution. There were too few non-Caucasian subjects to assess differences in populations defined by race adequately.

In the 12 week study, 78% of subjects achieved a 15% increase from baseline FEV₁ following the first dose of PERFOROMIST Inhalation Solution 20 mcg. In these subjects, the median time to onset of bronchodilation, defined as 15% increase in FEV₁, was 11.7 minutes. When defined as an increase in FEV₁ of 12% and 200 mL, the time to onset of bronchodilation was 13.1 minutes after dosing. The median time to peak bronchodilator effect was 2 hours after dosing.

16 HOW SUPPLIED/STORAGE AND HANDLING

PERFOROMIST (formoterol fumarate) Inhalation Solution is supplied as a 2 mL sterile solution for nebulization in 2.5 mL low-density polyethylene unit dose vials. Each vial is overwrapped in a foil pouch and supplied in cartons as listed below.

Carton of 60 individually wrapped unit dose vials, NDC 49502-605-61

Storage and Handling:

Prior to dispensing to the patient: Store in a refrigerator, 2°C to 8°C (36°F to 46°F)

After dispensing to the patient: Store at 2°C to 25°C (36°F to 77°F) for up to 3 months. Protect pouch from heat.

- PERFOROMIST Inhalation Solution should only be administered via a standard jet nebulizer connected to an air compressor with an adequate airflow and equipped with a facemask or mouthpiece.
- Vial should always be stored in the foil pouch, and only removed IMMEDIATELY before use.
- Do not take by mouth.
- Contents of any partially used container should be discarded.
- Discard the container and top after use.
- Keep out of the reach of children

17 PATIENT COUNSELING INFORMATION

Asthma Related Death

Patients should be informed that long acting beta agonists, such as PERFOROMIST, increase the risk of asthma-related death. All LABA, including PERFOROMIST, should not be used in patients with asthma without use of a long-term asthma control medication.

Acute Exacerbations or Deteriorations

PERFOROMIST Inhalation Solution is not indicated for relief of acute symptoms, and extra

doses should not be used for that purpose. Acute symptoms should be treated with an inhaled, short-acting beta₂-agonist (the healthcare provider should provide the patient with such medication and instruct the patient in how it should be used). Patients should be instructed to seek medical attention if their symptoms worsen despite recommended doses of PERFOROMIST Inhalation Solution, if PERFOROMIST Inhalation Solution treatment becomes less effective, or if they need more inhalations of a short-acting beta₂-agonist than usual.

Appropriate Dosing

Patients should not stop using PERFOROMIST Inhalation Solution unless told to do so by a healthcare provider because symptoms may get worse. Patients should not inhale more than the prescribed number of vials at any one time. The daily dosage of PERFOROMIST Inhalation Solution should not exceed one vial twice daily (40 mcg total daily dose). Excessive use of sympathomimetics may cause significant cardiovascular effects, and may be fatal.

Concomitant Therapy

Patients who have been taking inhaled, short-acting beta₂-agonists (e.g., albuterol) on a regular basis should be instructed to discontinue the regular use of these products and use them only for symptomatic relief of acute symptoms. PERFOROMIST Inhalation Solution should not be used in conjunction with other inhaled medications containing long-acting beta₂-agonists. Patients should be warned not to stop or change the dose of other concomitant COPD therapy without medical advice, even if symptoms improve after initiating treatment with PERFOROMIST Inhalation Solution.

Common Adverse Reactions with Beta₂-agonists

Patients should be informed that treatment with beta₂-agonists may lead to adverse reactions that include palpitations, chest pain, rapid heart rate, increased or decreased blood pressure, headache, tremor, nervousness, dry mouth, muscle cramps, nausea, dizziness, fatigue, malaise, low blood potassium, high blood sugar, high blood acid, or trouble sleeping [see ADVERSE REACTIONS (6.1)].

Instructions for Administration

It is important that patients understand how to use PERFOROMIST Inhalation Solution with a nebulizer appropriately [see the accompanying Medication Guide]. Patients should be instructed not to mix other medications with PERFOROMIST Inhalation Solution or ingest PERFOROMIST Inhalation Solution. Patients should throw the plastic dispensing container away immediately after use. Due to their small size, the container and top pose a danger of choking to young children.

FDA-Approved Medication Guide

See the accompanying Medication Guide.

Dey Logo

Dey Pharma, L.P., Napa, CA 94558

U.S. Pat. No. 6,667,344

U.S. Pat. No. 6,814,953

XX-XXX-XX

MEDICATION GUIDE
PERFOROMIST® (Per-FOR-o-mist)
(formoterol fumarate) Inhalation Solution

PERFOROMIST Inhalation Solution is only for use with a nebulizer.

Read the Medication Guide that comes with PERFOROMIST Inhalation Solution before you start using it and each time you get a refill. There may be new information. This Medication Guide does not take the place of talking to your healthcare provider about your medical condition or treatment.

What is the most important information I should know about PERFOROMIST Inhalation Solution?

PERFOROMIST Inhalation Solution can cause serious side effects including:

- **People with asthma who take long-acting beta₂ adrenergic agonist (LABA) medicines such as PERFOROMIST Inhalation Solution have an increased risk of death from asthma problems.**
- **It is not known if LABA medicines, such as PERFOROMIST Inhalation Solution, increase the risk of death in people with chronic obstructive pulmonary disease (COPD).**
- **Get emergency medical care if:**
 - **breathing problems worsen quickly**
 - **you use your rescue inhaler medicine, but it does not relieve your breathing problems**

What is PERFOROMIST Inhalation Solution?

PERFOROMIST Inhalation Solution is used long term, 2 times a day (morning and evening) in controlling symptoms of chronic obstructive pulmonary disease (COPD) in adults with COPD.

PERFOROMIST Inhalation Solution is only for use with a nebulizer. LABA medicines such as PERFOROMIST Inhalation Solution help the muscles around the airways in your lungs stay relaxed to prevent symptoms, such as wheezing, cough, chest tightness, and shortness of breath.

PERFOROMIST Inhalation Solution is not for use to treat sudden symptoms of COPD.

PERFOROMIST Inhalation Solution should not be used in children. It is not known if PERFOROMIST Inhalation Solution is safe and effective in children.

It is not known if PERFOROMIST Inhalation Solution is safe and effective in people with asthma.

Who should not use PERFOROMIST Inhalation Solution?

Do not use PERFOROMIST Inhalation Solution if you have asthma without using a long-term asthma control medicine.

What should I tell my healthcare provider before using PERFOROMIST Inhalation Solution?

Tell your healthcare provider about all of your health conditions, including if you:

- **have heart problems**
- **have high blood pressure**
- **have diabetes**
- **have seizures**
- **have thyroid problems**
- **have liver problems**
- **are pregnant or planning to become pregnant.** It is not known if PERFOROMIST Inhalation Solution can harm an unborn baby.
- **are breastfeeding.** It is not known if PERFOROMIST Inhalation Solution passes into breast milk and if it can harm your baby.

Tell your healthcare provider about all the medicines you take including prescription and non-prescription medicines, vitamins and herbal supplements. PERFOROMIST Inhalation Solution and certain other medicines may interact with each other. This may cause serious side effects.

Know the medicines you take. Keep a list of them to show your healthcare provider and pharmacist each time you get a new medicine.

How should I use PERFOROMIST Inhalation Solution?

Read the step-by-step instructions for using PERFOROMIST Inhalation Solution at the end of this Medication Guide.

- Use PERFOROMIST Inhalation Solution exactly as prescribed. One ready-to-use vial of PERFOROMIST Inhalation Solution is one dose. The usual dose of PERFOROMIST Inhalation Solution is one ready to-use vial, twice a day (morning and evening) breathed in through your nebulizer machine. The 2 doses should be about 12 hours apart. **Do not use more than 2 vials of PERFOROMIST Inhalation Solution a day.**
- Do not mix other medicines with PERFOROMIST Inhalation Solution in your nebulizer machine.

If you miss a dose of PERFOROMIST Inhalation Solution, just skip that dose. Take your next dose at your usual time. Do not take 2 doses at one time.

- While you are using PERFOROMIST Inhalation Solution 2 times each day:

- **do not use** other medicines that contain a long-acting beta₂-agonist (LABA) for any reason.
- **do not use** your short-acting beta₂-agonist medicine on a regular basis (four times a day).
- **PERFOROMIST Inhalation Solution does not relieve sudden symptoms of COPD.** Always have a rescue inhaler medicine with you to treat sudden symptoms. If you do not have rescue inhaler medicine, call your healthcare provider to have one prescribed for you.
- Do not stop using **PERFOROMIST Inhalation Solution** or other medicines to control or treat your COPD unless told to do so by your healthcare provider because your symptoms might get worse. Your healthcare provider will change your medicines as needed.
- **Do not use PERFOROMIST Inhalation Solution:**
 - **more often than prescribed,**
 - **more medicine than prescribed for you, or**
 - **with other LABA medicines**

Call your healthcare provider or get emergency medical care right away if:

- your breathing problems worsen with PERFOROMIST Inhalation Solution
- you need to use your rescue inhaler medicine more often than usual
- your rescue inhaler medicine does not work as well for you at relieving symptoms

What are the possible side effects of PERFOROMIST Inhalation Solution?

PERFOROMIST Inhalation Solution can cause serious side effects, including:

- See “**What is the most important information I should know about PERFOROMIST Inhalation Solution?**”
- **Sudden shortness of breath immediately after use of PERFOROMIST Inhalation Solution.**
- **Serious allergic reactions including rash, hives, swelling of the face, mouth, and tongue, and breathing problems.** Call your healthcare provider or get emergency medical care if you get any symptoms of a serious allergic reaction.
- **chest pain**
- **increased or decreased blood pressure**
- **a fast and irregular heartbeat**
- **low blood potassium**
- **high blood sugar**
- **high blood acid**

Common side effects of PERFOROMIST Inhalation Solution include:

- **headache**
- **tremor**
- **nervousness**
- **dry mouth**
- **muscle cramps**
- **nausea, vomiting**
- **diarrhea**
- **dizziness**
- **tiredness**
- **trouble sleeping**

If your COPD symptoms worsen over time do not increase your dose of PERFOROMIST Inhalation Solution, instead call your healthcare provider.

Tell your healthcare provider if you get any side effect that bothers you or that does not go away.

These are not all the side effects with PERFOROMIST Inhalation Solution. Ask your healthcare provider or pharmacist for more information.

Call your doctor for medical advice about side effects. You may report side effects to FDA at 1-800-FDA-1088.

How should I store PERFOROMIST Inhalation Solution?

- Store PERFOROMIST Inhalation Solution in a refrigerator between 36° to 46°F (2° to 8°C) in the protective foil pouch. Protect from light and heat. **Do not open a sealed pouch until you are ready to use a dose of PERFOROMIST Inhalation Solution. Once a sealed pouch is opened, PERFOROMIST Inhalation Solution must be used right away.** PERFOROMIST Inhalation Solution may be used directly from the refrigerator.
- PERFOROMIST Inhalation Solution may also be stored at room temperature between 68°F to 77°F (20°C to 25°C) for up to 3 months (90 days). If stored at room temperature, discard PERFOROMIST Inhalation Solution if it is not used after 3 months or if past the expiration date, whichever is sooner. Space is provided on the packaging to record dispense date and use by date.
- Do not use PERFOROMIST Inhalation Solution after the expiration date provided on the foil pouch and vial.
- PERFOROMIST Inhalation Solution should be colorless. Discard PERFOROMIST Inhalation Solution if it is not colorless.

- **Keep PERFOROMIST Inhalation Solution and all medicines out of the reach of children.**

General Information about PERFOROMIST Inhalation Solution

Medicines are sometimes prescribed for purposes that are not mentioned in a Medication Guide. Do not use PERFOROMIST Inhalation Solution for a condition for which it was not prescribed. Do not give PERFOROMIST Inhalation Solution to other people, even if they have the same condition. It may harm them.

This Medication Guide summarizes the most important information about PERFOROMIST Inhalation Solution. If you would like more information, talk with your healthcare provider. You can ask your healthcare provider or pharmacist for information about PERFOROMIST Inhalation Solution that was written for healthcare professionals.

- For customer service, call 1-800-395-3376
- To report side effects, call 1-877-446-3679
- For medical information, call 1-800-429-7751

Instructions for Using PERFOROMIST (formoterol fumarate) Inhalation Solution

PERFOROMIST Inhalation Solution is used only in a standard jet nebulizer machine connected to an air compressor. Make sure you know how to use your nebulizer machine before you use it to breathe in PERFOROMIST Inhalation Solution or other medicines.

Do not mix PERFOROMIST Inhalation Solution with other medicines in your nebulizer machine.

PERFOROMIST Inhalation Solution comes sealed in a foil pouch. Do not open a sealed pouch until you are ready to use a dose of PERFOROMIST Inhalation Solution.

1. Remove vial from the foil pouch.
2. Twist the cap completely off the vial and squeeze all the medicine into the nebulizer medicine cup (reservoir) (Figure 1).

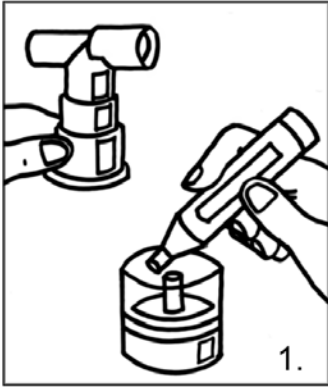

3. Connect the nebulizer reservoir to the mouthpiece or facemask (Figure 2).

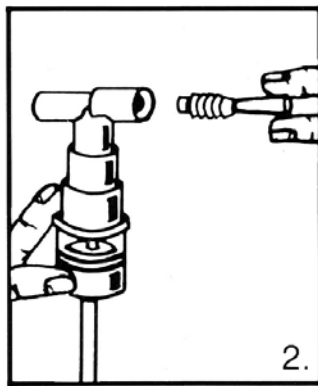

4. Connect the nebulizer to the compressor.

5. Sit in a comfortable, upright position. Place the mouthpiece in your mouth (Figure 3) or put on the facemask (Figure 4); and turn on the compressor.

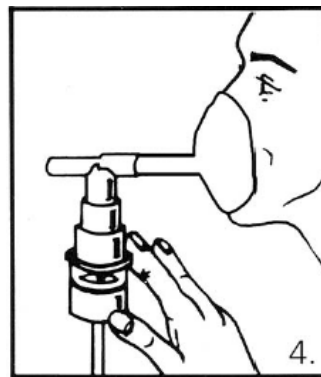
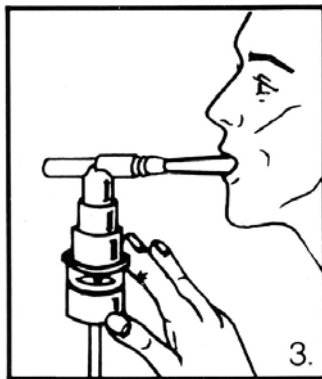

6. Breathe as calmly, deeply and evenly as possible through your mouth until no more mist is formed in the nebulizer reservoir. The average nebulization time is 9 minutes. At this point, the treatment is finished.

7. Discard the PERFOROMIST Inhalation Solution container and top after use.

8. Clean the nebulizer (see manufacturer's instructions).

[Dey Logo]

Dey Pharma, L.P.
Napa, CA 94558 U.S.A.

Revised May 2010

This Medication Guide has been approved by the U.S. Food and Drug Administration

XX-XXX-XX