

HIGHLIGHTS OF PRESCRIBING INFORMATION

These highlights do not include all the information needed to use IMPLANON safely and effectively. See full prescribing information for IMPLANON.

IMPLANON® (etonogestrel implant), for subdermal use
Initial U.S. Approval: 2001

INDICATIONS AND USAGE

IMPLANON is a progestin indicated for use by women to prevent pregnancy. (1)

DOSAGE AND ADMINISTRATION

Insert one IMPLANON subdermally just under the skin at the inner side of the non-dominant upper arm. IMPLANON must be removed no later than by the end of the third year. (2)

DOSAGE FORMS AND STRENGTHS

IMPLANON consists of a single, rod-shaped implant, containing 68 mg etonogestrel, pre-loaded in the needle of a disposable applicator. (3)

CONTRAINDICATIONS

- Known or suspected pregnancy (4)
- Current or past history of thrombosis or thromboembolic disorders (4, 5.4)
- Liver tumors, benign or malignant, or active liver disease (4, 5.7)
- Undiagnosed abnormal genital bleeding (4, 5.2)
- Known or suspected breast cancer, personal history of breast cancer, or other progestin-sensitive cancer, now or in the past (4, 5.6)
- Allergic reaction to any of the components of IMPLANON (4, 6)

WARNINGS AND PRECAUTIONS

- Insertion and removal complications: Pain, paresthesias, bleeding, hematoma, scarring or infection may occur. (5.1)
- Menstrual bleeding pattern: Counsel women regarding changes in bleeding frequency, intensity, or duration. (5.2)

- Ectopic pregnancies: Be alert to the possibility of an ectopic pregnancy in women using IMPLANON who become pregnant or complain of lower abdominal pain. (5.3)
- Thrombotic and other vascular events: The IMPLANON implant should be removed in the event of a thrombosis. (5.4)
- Liver disease: Remove the IMPLANON implant if jaundice occurs. (5.7)
- Elevated blood pressure: The IMPLANON implant should be removed if blood pressure rises significantly and becomes uncontrolled. (5.9)
- Carbohydrate and lipid metabolic effects: Monitor prediabetic and diabetic women using IMPLANON. (5.11)

ADVERSE REACTIONS

Most common ($\geq 10\%$) adverse reactions reported in clinical trials were change in menstrual bleeding pattern, headache, vaginitis, weight increase, acne, breast pain, abdominal pain, and pharyngitis. (6.1)

To report SUSPECTED ADVERSE REACTIONS, contact Merck Sharp & Dohme Corp., a subsidiary of Merck & Co., Inc., at 1-877-888-4231 or FDA at 1-800-FDA-1088 or www.fda.gov/medwatch.

DRUG INTERACTIONS

Drugs or herbal products that induce certain enzymes, such as CYP3A4, may decrease the effectiveness of progestin hormonal contraceptives or increase breakthrough bleeding. (7.1)

USE IN SPECIFIC POPULATIONS

- Pregnant women: IMPLANON should be removed if maintaining a pregnancy. (8.1)
- Overweight women: IMPLANON may become less effective in overweight women over time, especially in the presence of other factors that decrease etonogestrel concentrations, such as concomitant use of hepatic enzyme inducers. (8.8)

See 17 for PATIENT COUNSELING INFORMATION and FDA-approved patient labeling.

Revised: 07/2014

FULL PRESCRIBING INFORMATION: CONTENTS*

1 INDICATIONS AND USAGE

2 DOSAGE AND ADMINISTRATION

- 2.1 Initiating Contraception with IMPLANON
- 2.2 Insertion of IMPLANON
- 2.3 Removal of IMPLANON
- 2.4 Replacing IMPLANON

3 DOSAGE FORMS AND STRENGTHS

4 CONTRAINDICATIONS

5 WARNINGS AND PRECAUTIONS

- 5.1 Complications of Insertion and Removal
- 5.2 Changes in Menstrual Bleeding Patterns
- 5.3 Ectopic Pregnancies
- 5.4 Thrombotic and Other Vascular Events
- 5.5 Ovarian Cysts
- 5.6 Carcinoma of the Breast and Reproductive Organs
- 5.7 Liver Disease
- 5.8 Weight Gain
- 5.9 Elevated Blood Pressure
- 5.10 Gallbladder Disease
- 5.11 Carbohydrate and Lipid Metabolic Effects
- 5.12 Depressed Mood
- 5.13 Return to Ovulation
- 5.14 Fluid Retention
- 5.15 Contact Lenses
- 5.16 Monitoring
- 5.17 Drug-Laboratory Test Interactions

6 ADVERSE REACTIONS

- 6.1 Clinical Trials Experience
- 6.2 Postmarketing Experience

7 DRUG INTERACTIONS

- 7.1 Changes in Contraceptive Effectiveness Associated with Coadministration of Other Products
- 7.2 Increase in Plasma Concentrations of Etonogestrel Associated with Coadministered Drugs
- 7.3 Changes in Plasma Concentrations of Coadministered Drugs

8 USE IN SPECIFIC POPULATIONS

- 8.1 Pregnancy
- 8.3 Nursing Mothers
- 8.4 Pediatric Use
- 8.5 Geriatric Use
- 8.6 Hepatic Impairment
- 8.7 Renal Impairment
- 8.8 Overweight Women

10 OVERDOSAGE

11 DESCRIPTION

12 CLINICAL PHARMACOLOGY

- 12.1 Mechanism of Action
- 12.2 Pharmacodynamics
- 12.3 Pharmacokinetics

13 NONCLINICAL TOXICOLOGY

- 13.1 Carcinogenesis, Mutagenesis, Impairment of Fertility

14 CLINICAL STUDIES

- 14.1 Pregnancy
- 14.2 Return to Ovulation

16 HOW SUPPLIED/STORAGE AND HANDLING

- 16.1 How Supplied
- 16.2 Storage and Handling

17 PATIENT COUNSELING INFORMATION

*Sections or subsections omitted from the full prescribing information are not listed.

FULL PRESCRIBING INFORMATION

1 INDICATIONS AND USAGE

IMPLANON® is indicated for use by women to prevent pregnancy.

2 DOSAGE AND ADMINISTRATION

The efficacy of IMPLANON does not depend on daily, weekly or monthly administration.

All healthcare providers should receive instruction and training prior to performing insertion and/or removal of IMPLANON.

A single IMPLANON implant is inserted subdermally in the upper arm. To reduce the risk of neural or vascular injury, the implant should be inserted at the inner side of the non-dominant upper arm about 8-10 cm (3-4 inches) above the medial epicondyle of the humerus. The implant should be inserted subdermally just under the skin to avoid the large blood vessels and nerves that lie deeper in the subcutaneous tissues in the sulcus between the triceps and biceps muscles. IMPLANON must be inserted by the expiration date stated on the packaging. IMPLANON is a long-acting (up to 3 years), reversible, hormonal contraceptive method. The implant must be removed by the end of the third year and may be replaced by a new implant at the time of removal, if continued contraceptive protection is desired.

2.1 Initiating Contraception with IMPLANON

IMPORTANT: Rule out pregnancy before inserting the implant.

Timing of insertion depends on the woman's recent contraceptive history, as follows:

- No preceding hormonal contraceptive use in the past month

IMPLANON should be inserted between Day 1 (first day of menstrual bleeding) and Day 5 of the menstrual cycle, even if the woman is still bleeding.

If inserted as recommended, back-up contraception is not necessary. If deviating from the recommended timing of insertion, the woman should be advised to use a barrier method until 7 days after insertion. If intercourse has already occurred, pregnancy should be excluded.

- Switching contraceptive method to IMPLANON

Combination hormonal contraceptives:

IMPLANON should preferably be inserted on the day after the last active tablet of the previous combined oral contraceptive or on the day of the removal of the vaginal ring or transdermal patch. At the latest, IMPLANON should be inserted on the day following the usual tablet-free, ring-free, patch-free or placebo tablet interval of the previous combined hormonal contraceptive.

If inserted as recommended, back-up contraception is not necessary. If deviating from the recommended timing of insertion, the woman should be advised to use a barrier method until 7 days after insertion. If intercourse has already occurred, pregnancy should be excluded.

Progestin-only contraceptives:

There are several types of progestin-only methods. IMPLANON should be inserted as follows:

- **Injectable Contraceptives:** Insert IMPLANON on the day the next injection is due.
- **Minipill:** A woman may switch to IMPLANON on any day of the month. IMPLANON should be inserted within 24 hours after taking the last tablet.
- **Contraceptive implant or intrauterine system (IUS):** Insert IMPLANON on the same day as the previous contraceptive implant or IUS is removed.

If inserted as recommended, back-up contraception is not necessary. If deviating from the recommended timing of insertion, the woman should be advised to use a barrier method until 7 days after insertion. If intercourse has already occurred, pregnancy should be excluded.

- Following abortion or miscarriage

- **First Trimester:** IMPLANON should be inserted within 5 days following a first trimester abortion or miscarriage.
- **Second Trimester:** Insert IMPLANON between 21 to 28 days following second trimester abortion or miscarriage.

If inserted as recommended, back-up contraception is not necessary. If deviating from the recommended timing of insertion, the woman should be advised to use a barrier method until 7 days after insertion. If intercourse has already occurred, pregnancy should be excluded.

- Postpartum

- Not Breastfeeding: IMPLANON should be inserted between 21 to 28 days postpartum. If inserted as recommended, back-up contraception is not necessary. If deviating from the recommended timing of insertion, the woman should be advised to use a barrier method until 7 days after insertion. If intercourse has already occurred, pregnancy should be excluded.
- Breastfeeding: IMPLANON should be inserted after the fourth postpartum week [see *Use in Specific Populations (8.3)*]. The woman should be advised to use a barrier method until 7 days after insertion. If intercourse has already occurred, pregnancy should be excluded.

2.2 Insertion of IMPLANON

The basis for successful use and subsequent removal of IMPLANON is a correct and carefully performed subdermal insertion of the single, rod-shaped implant in accordance with the instructions. Both the healthcare provider and the woman should be able to feel the implant under the skin after placement.

All healthcare providers performing insertions and/or removals of IMPLANON should receive instructions and training prior to inserting or removing the implant. Information concerning the insertion and removal of IMPLANON will be sent upon request free of charge [1-877-IMPLANON (1-877-467-5266)].

Preparation

Prior to inserting IMPLANON carefully read the instructions for insertion as well as the full prescribing information.

Before insertion of IMPLANON, the healthcare provider should confirm that:

- The woman is not pregnant nor has any other contraindication for the use of IMPLANON [see *Contraindications (4)*].
- The woman has had a medical history and physical examination, including a gynecologic examination, performed.
- The woman understands the benefits and risks of IMPLANON.
- The woman has received a copy of the Patient Labeling included in packaging.
- The woman has reviewed and completed a consent form to be maintained with the woman's chart.
- The woman does not have allergies to the antiseptic and anesthetic to be used during insertion.

Insert IMPLANON under aseptic conditions.

The following equipment is needed for the implant insertion:

- An examination table for the woman to lie on
- Sterile surgical drapes, sterile gloves, antiseptic solution, sterile marker (optional)
- Local anesthetic, needles, and syringe
- Sterile gauze, adhesive bandage, pressure bandage

An applicator and its parts are shown below (Figures 1a and 1b).

Figure 1a (Not to scale)

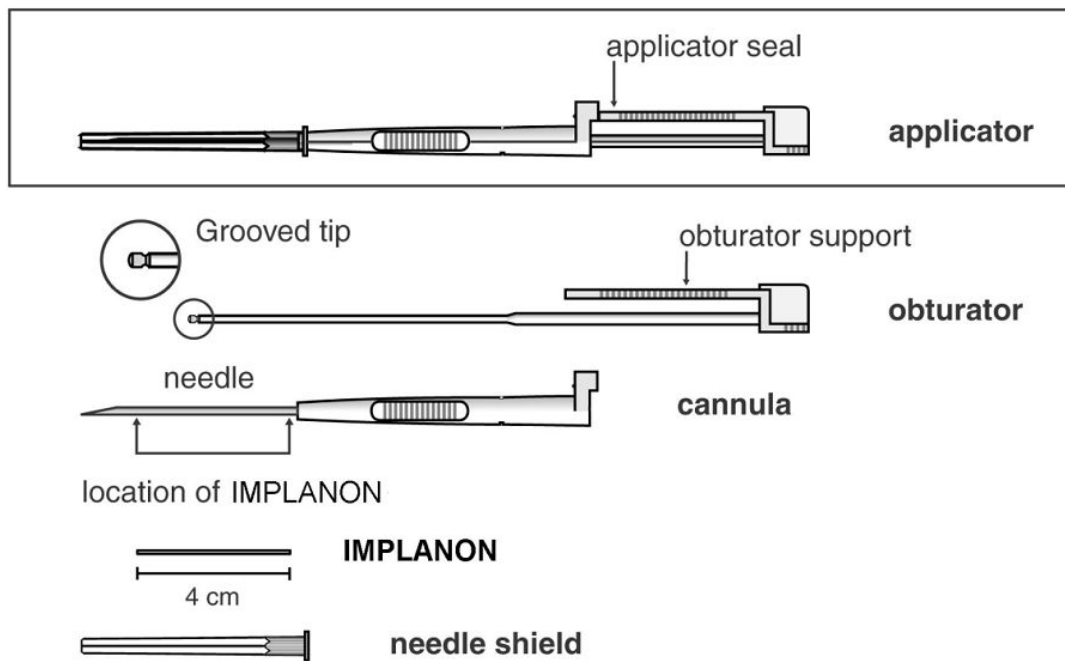
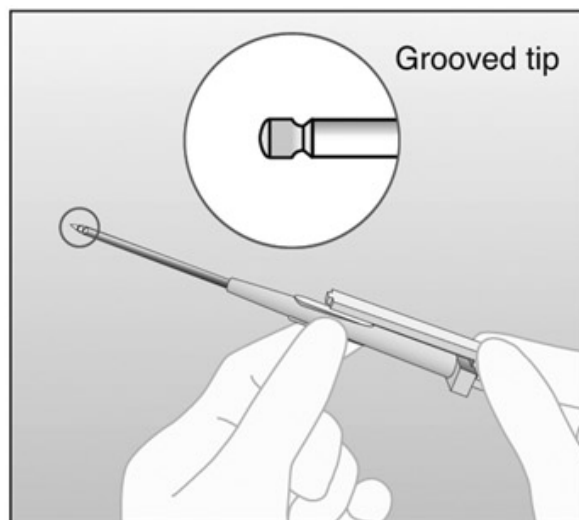

Figure 1b



Grooved tip of obturator (enlarged)

The procedure used for IMPLANON insertion is opposite from that of an injection. The obturator keeps IMPLANON in place while the cannula is retracted. The obturator must remain fixed in place while the cannula with needle is retracted from the arm. Do not push the obturator.

Insertion Procedure

Step 1. Have the woman lie on her back on the examination table with her non-dominant arm flexed at the elbow and externally rotated so that her wrist is parallel to her ear or her hand is positioned next to her head (Figure 2).

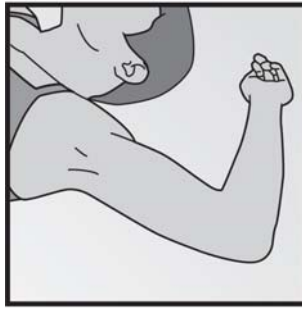

Figure 2

Step 2. Identify the insertion site, which is at the inner side of the non-dominant upper arm about 8-10 cm (3-4 inches) above the medial epicondyle of the humerus (Figure 3). **The implant should be inserted subdermally just under the skin to avoid the large blood vessels and nerves that lie deeper in the subcutaneous tissue in the sulcus between the triceps and biceps muscles** [see *Warnings and Precautions* (5.1)].

Step 3. Make two marks with a sterile marker: first, mark the spot where the etonogestrel implant will be inserted, and second, mark a spot a few centimeters proximal to the first mark (Figure 3). This second mark will later serve as a direction guide during insertion.

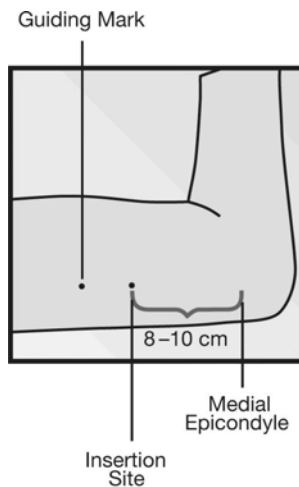

Figure 3

Step 4. Clean the insertion site with an antiseptic solution.

Step 5. Anesthetize the insertion area (for example, with anesthetic spray or by injecting 2 mL of 1% lidocaine just under the skin along the planned insertion tunnel).

Step 6. Remove the sterile pre-loaded disposable IMPLANON applicator carrying the implant from its blister. Keep the IMPLANON needle and rod sterile. The applicator should not be used if sterility is in question. If contamination occurs, use a new package of IMPLANON with a new sterile applicator.

Step 7. Keep the shield on the needle and look for the IMPLANON rod, seen as a white cylinder inside the needle tip.

Step 8. If you don't see the IMPLANON rod, tap the top of the needle shield against a firm surface to bring the implant into the needle tip.

Step 9. Following visual confirmation, lower the IMPLANON rod back into the needle by tapping it back into the needle tip. Then remove the needle shield, while holding the applicator upright.

Step 10. **Note that IMPLANON can fall out of the needle.** Therefore, after you remove the needle shield, keep the applicator in the upright position until the moment of insertion

Step 11. With your free hand, stretch the skin around the insertion site with thumb and index finger (Figure 4).

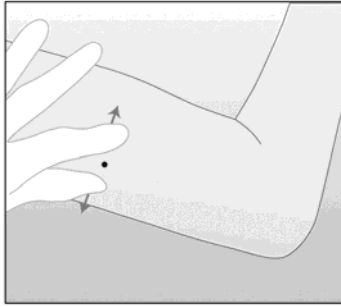

Figure 4

Step 12. At a slight angle (not greater than 20°), insert **only** the tip of the needle with the beveled side up into the insertion site (Figure 5).

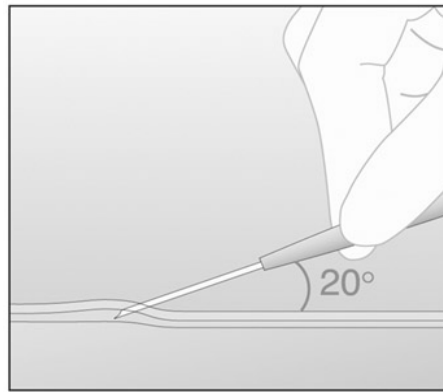

Figure 5

Step 13. Lower the applicator to a horizontal position. Lift the skin up with the tip of the needle, but **keep the needle in the subdermal connective tissue** (Figure 6).

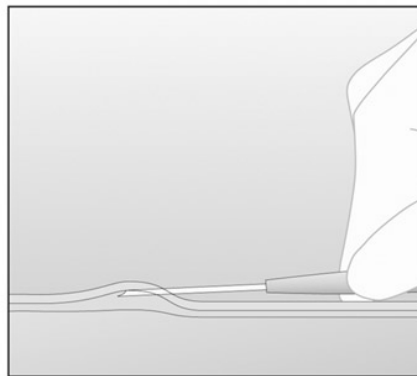

Figure 6

Step 14. While “tenting” (lifting) the skin, gently insert the needle to its full length. Keep the needle parallel to the surface of the skin during insertion (Figure 7).

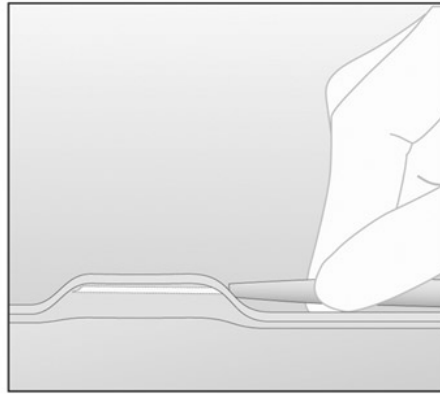

Figure 7

- Step 15. **If IMPLANON is placed too deeply, the removal process can be difficult or impossible. If the needle is not inserted to its full length, the implant may protrude from the insertion site and fall out.**
- Step 16. Break the seal of the applicator by pressing the obturator support (Figure 8).

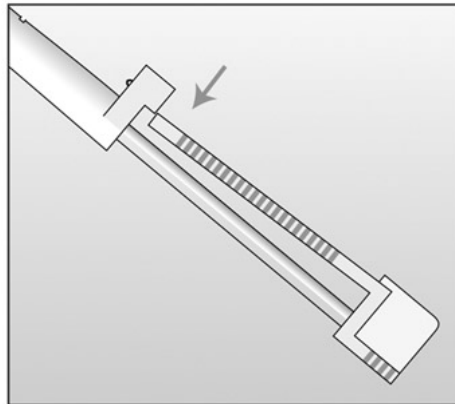

Figure 8

- Step 17. Turn the obturator 90° in either direction with respect to the needle (Figure 9).

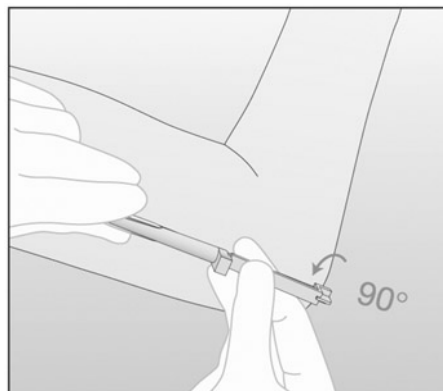

Figure 9

Step 18. While holding the obturator fixed in place on the arm, fully retract the cannula (Figure 10). **Note: This procedure is opposite from an injection. Do not push the obturator. By holding the obturator fixed in place on the arm and fully retracting the cannula, the implant will be left in its correct subdermal position. Do not simultaneously retract the obturator and cannula from the patient's arm.**

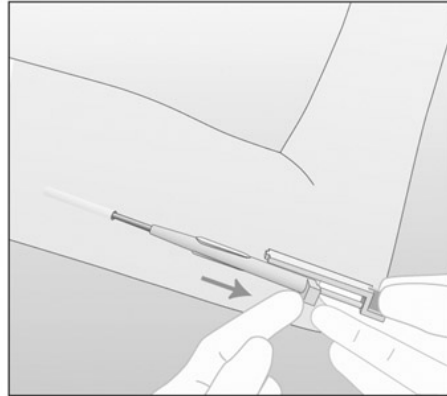

Figure 10

In this figure, the right hand is holding the obturator in place while the left hand is retracting the cannula.

Step 19. Confirm that the implant has been inserted by checking the tip of the needle for the absence of the implant. After insertion of the implant, the grooved tip of the obturator will be visible inside the needle (Figure 11).

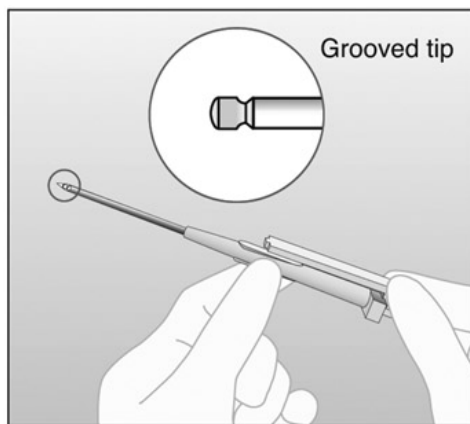

Figure 11

Step 20. **Always verify the presence of the implant in the woman's arm immediately after insertion by palpation.** By palpating both ends of the implant, you should be able to confirm the presence of the 4-cm rod (Figure 12).

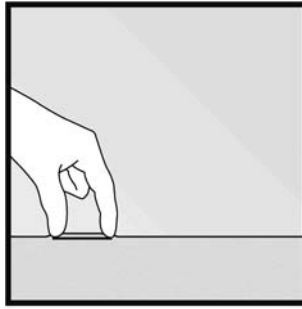

Figure 12

If you cannot feel the implant or are in doubt of its presence,

- Check the tip of the needle for the absence of the implant. After insertion of the implant, the grooved tip of the obturator will be visible inside the needle.
- Use other methods to confirm the presence of the implant. Suitable methods to locate are: ultrasound (US) with a high-frequency linear array transducer (10 MHz or greater) or magnetic resonance imaging (MRI). Please note that the IMPLANON rod is not radiopaque and cannot be seen by X-ray or CT scan. If ultrasound and MRI fail, call 1-877-IMPLANON (1-877-467-5266) for information on the procedure for measuring etonogestrel blood levels.

Until the presence of the implant has been verified, the woman should be advised to use a non-hormonal contraceptive method, such as condoms.

Step 21. Place a small adhesive bandage over the insertion site. Request that the woman palpate the implant.

Step 22. Apply a pressure bandage with sterile gauze to minimize bruising. The woman may remove the pressure bandage in 24 hours and the small bandage over the insertion site in 3 to 5 days.

Step 23. Complete the USER CARD and give it to the woman to keep. Also, complete the PATIENT CHART LABEL and affix it to the woman's medical record.

Step 24. The applicator is for single use only and should be disposed in accordance with the Center for Disease Control and Prevention guidelines for handling of hazardous waste.

2.3 Removal of IMPLANON

Preparation

Before initiating the removal procedure, the healthcare provider should carefully read the instructions for removal and consult the USER CARD and/or the PATIENT CHART LABEL for the location of the implant. The exact location of the implant in the arm should be verified by palpation. If the implant is not palpable, ultrasound with a high-frequency linear array transducer (10 MHz or greater) or magnetic resonance imaging can be performed to verify its presence.

A non-palpable implant should always be first located prior to removal. Suitable methods for localization include ultrasound with a high-frequency linear array transducer (10 MHz or greater) or magnetic resonance imaging. If these imaging methods fail to locate the implant, etonogestrel blood level determination can be used for verification of the presence of the implant. For details on etonogestrel blood level determination, call 1-877-IMPLANON (1-877-467-5266) for further instructions.

After localization of a non-palpable implant, consider conducting removal with ultrasound guidance.

There have been occasional reports of migration of the implant; usually this involves minor movement relative to the original position. This may complicate localization of the implant by palpation, ultrasound or magnetic resonance imaging, and removal may require a larger incision and more time.

Exploratory surgery without knowledge of the exact location of the implant is strongly discouraged. Removal of deeply inserted implants should be conducted with caution in order to prevent injury to deeper neural or vascular structures in the arm and be performed by healthcare providers familiar with the anatomy of the arm.

Before removal of the implant, the healthcare provider should confirm that:

- The woman does not have allergies to the antiseptic or anesthetic to be used.

Remove the implant under aseptic conditions.

The following equipment is needed for removal of the implant:

- An examination table for the woman to lie on

- Sterile surgical drapes, sterile gloves, antiseptic solution, sterile marker (optional)
- Local anesthetic, needles, and syringe
- Sterile scalpel, forceps (straight and curved mosquito)
- Skin closure, sterile gauze, adhesive bandage and pressure bandages

Removal Procedure

Step 1. Clean the site where the incision will be made and apply an antiseptic. Locate the implant by palpation and mark the distal end (end closest to the elbow), for example, with a sterile marker (Figure 13).

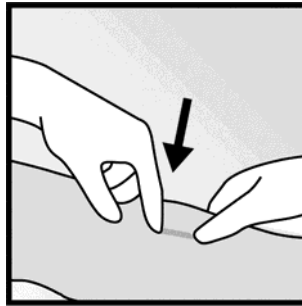

Figure 13

Step 2. Anesthetize the arm, for example, with 0.5 to 1 mL 1% lidocaine at the marked site where the incision will be made (Figure 14). Be sure to inject the local anesthetic **under** the implant to keep it close to the skin surface.

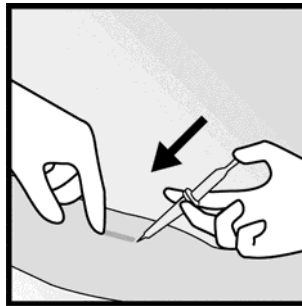

Figure 14

Step 3. Push down the proximal end of the implant (Figure 15) to stabilize it; a bulge may appear indicating the distal end of the implant. Starting at the distal tip of the implant, make a longitudinal incision of 2 mm towards the elbow.

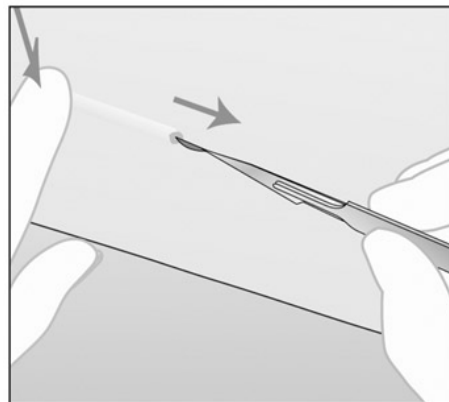

Figure 15

Step 4. Gently push the implant towards the incision until the tip is visible. Grasp the implant with forceps (preferably curved mosquito forceps) and gently remove the implant (Figure 16).

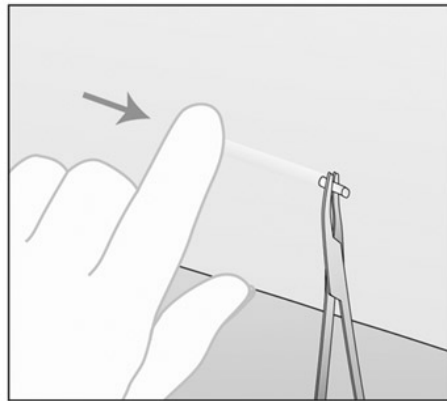

Figure 16

Step 5. If the implant is encapsulated, make an incision into the tissue sheath and then remove the implant with the forceps (Figures 17 and 18).

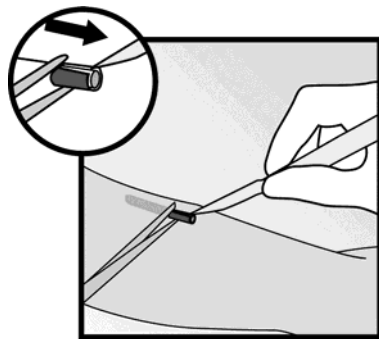

Figure 17

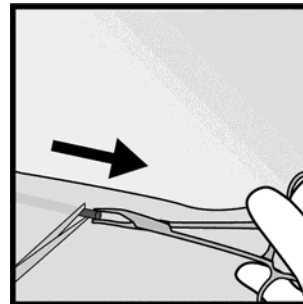

Figure 18

Step 6. If the tip of the implant does not become visible in the incision, gently insert a forceps into the incision (Figure 19). Flip the forceps over into your other hand (Figure 20).

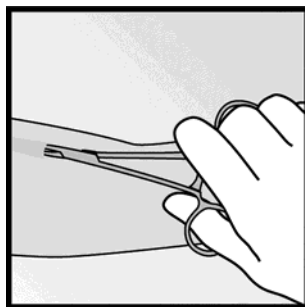

Figure 19

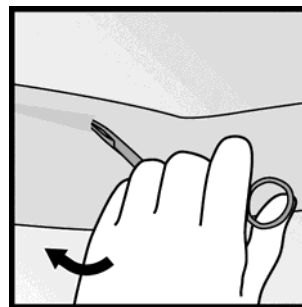

Figure 20

Step 7. With a second pair of forceps carefully dissect the tissue around the implant and grasp the implant (Figure 21). The implant can then be removed.

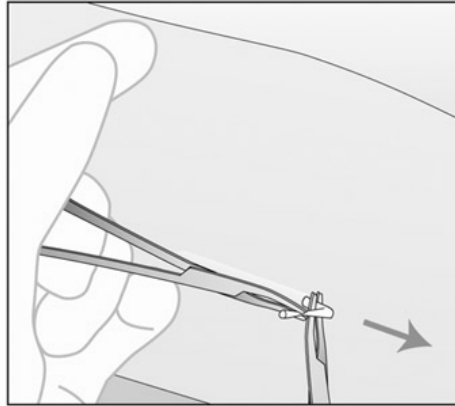

Figure 21

Step 8. Confirm that the entire implant, which is 4 cm long, has been removed by measuring its length. If a partial implant (less than 4 cm) is removed, the remaining piece should be removed by following the instructions in section 2.3. [See *Dosage and Administration (2.3)*.] If the woman would like to continue using IMPLANON, a new implant may be inserted immediately after the old implant is removed using the same incision [see *Dosage and Administration (2.4)*].

Step 9. After removing the implant, close the incision with a steri-strip and apply an adhesive bandage.

Step 10. Apply a pressure bandage with sterile gauze to minimize bruising. The woman may remove the pressure bandage in 24 hours and the small bandage in 3 to 5 days.

2.4 Replacing IMPLANON

Immediate replacement can be done after removal of the previous implant and is similar to the insertion procedure described in section 2.2 Insertion of IMPLANON.

The new implant may be inserted in the same arm, and through the same incision from which the previous implant was removed. If the same incision is being used to insert a new implant, anesthetize the insertion site [for example, 2 mL lidocaine (1%)] applying it just under the skin along the 'insertion canal.'

Follow the subsequent steps in the insertion instructions [see *Dosage and Administration (2.2)*].

3 DOSAGE FORMS AND STRENGTHS

Single, off-white, soft, flexible, ethylene vinylacetate (EVA) implant, 4 cm in length and 2 mm in diameter containing 68 mg etonogestrel.

4 CONTRAINDICATIONS

IMPLANON should not be used in women who have

- Known or suspected pregnancy
- Current or past history of thrombosis or thromboembolic disorders
- Liver tumors, benign or malignant, or active liver disease
- Undiagnosed abnormal genital bleeding
- Known or suspected breast cancer, personal history of breast cancer, or other progestin-sensitive cancer, now or in the past
- Allergic reaction to any of the components of IMPLANON [see *Adverse Reactions (6)*]

5 WARNINGS AND PRECAUTIONS

The following information is based on experience with either IMPLANON, other progestin-only contraceptives, or experience with combination (estrogen plus progestin) oral contraceptives.

5.1 Complications of Insertion and Removal

IMPLANON should be inserted subdermally so that it will be palpable after insertion, and this should be confirmed by palpation immediately after insertion. Failure to insert IMPLANON properly may go unnoticed unless it is palpated immediately after insertion. Undetected failure to insert the implant may lead to an unintended pregnancy. Complications related to insertion and removal procedures, such as pain, paresthesias, bleeding, hematoma, scarring or infection, may occur. Occasionally in post-marketing use, implant insertions have failed because the implant fell out of the needle or remained in the needle during insertion.

If IMPLANON is inserted too deeply (intramuscular or in the fascia), neural or vascular injury may occur. To reduce the risk of neural or vascular injury, IMPLANON should be inserted at the inner side of the non-dominant upper arm about 8-10 cm (3-4 inches) above the medial epicondyle of the humerus. IMPLANON should be inserted subdermally just under the skin to avoid the

large blood vessels and nerves that lie deeper in the subcutaneous tissues in the sulcus between the triceps and biceps muscles. Deep insertions of IMPLANON have been associated with paraesthesia (due to neural injury) and migration of the implant (due to intramuscular or fascial insertion), and in a very few cases with intravascular insertion. If infection develops at the insertion site, start suitable treatment. If the infection persists, the implant should be removed. Incomplete insertions or infections may lead to expulsion. In postmarketing use there have been cases of failure to localize and remove the implant, probably due to deep insertion. There has been 1 case of an intravascular insertion reported post-marketing which led to inability to remove the implant.

Implant removal may be difficult or impossible if the implant is not inserted correctly, is inserted too deeply, not palpable, encased in fibrous tissue, or has migrated. Deep insertions may lead to difficult localization of the implant and may also result in the need for a surgical procedure in an operating room in order to remove the implant. Exploratory surgery without knowledge of the exact location of the implant is strongly discouraged. Removal of deeply inserted implants should be conducted with caution in order to prevent injury to deeper neural or vascular structures in the arm and be performed by healthcare providers familiar with the anatomy of the arm. Failure to remove the implant may result in continued effects of etonogestrel, such as compromised fertility, ectopic pregnancy, or persistence or occurrence of a drug-related adverse event.

5.2 Changes in Menstrual Bleeding Patterns

After starting IMPLANON, women are likely to have a change from their normal menstrual bleeding pattern. These may include changes in bleeding frequency (absent, less, more frequent or continuous), intensity (reduced or increased) or duration. In clinical trials, bleeding patterns ranged from amenorrhea (1 in 5 women) to frequent and/or prolonged bleeding (1 in 5 women). The bleeding pattern experienced during the first three months of IMPLANON use is broadly predictive of the future bleeding pattern for many women. Women should be counseled regarding the bleeding pattern changes they may experience so that they know what to expect. Abnormal bleeding should be evaluated as needed to exclude pathologic conditions or pregnancy.

In clinical studies of IMPLANON, reports of changes in bleeding pattern were the most common reason for stopping treatment (11.1%). Irregular bleeding (10.8%) was the single most common reason women stopped treatment, while amenorrhea (0.3%) was cited less frequently. In these studies, women had an average of 17.7 days of bleeding or spotting every 90 days (based on 3,315 intervals of 90 days recorded by 780 patients). The percentages of patients having 0, 1-7, 8-21, or >21 days of spotting or bleeding over a 90-day interval while using the IMPLANON implant are shown in Table 1.

Table 1: Percentages of Patients with 0, 1 - 7, 8 - 21, or >21 Days of Spotting or Bleeding Over a 90-Day Interval While Using IMPLANON

Total Days of Spotting or Bleeding	Percentage of Patients		
	Treatment Days 91-180 (N = 745)	Treatment Days 271-360 (N = 657)	Treatment Days 631-720 (N = 547)
0 Days	19%	24%	17%
1-7 Days	15%	13%	12%
8-21 Days	30%	30%	37%
>21 Days	35%	33%	35%

Bleeding patterns observed with use of IMPLANON for up to 2 years, and the proportion of 90-day intervals with these bleeding patterns, are summarized in Table 2.

Table 2: Bleeding Patterns Using IMPLANON during the First 2 Years of Use*

BLEEDING PATTERNS	DEFINITIONS	% [†]
Infrequent	Less than three bleeding and/or spotting episodes in 90 days (excluding amenorrhea)	33.6
Amenorrhea	No bleeding and/or spotting in 90 days	22.2
Prolonged	Any bleeding and/or spotting episode lasting more than 14 days in 90 days	17.7
Frequent	More than 5 bleeding and/or spotting episodes in 90 days	6.7

* Based on 3,315 recording periods of 90 day's duration in 780 women, excluding the first 90 days after implant insertion

[†] % = Percentage of 90-day intervals with this pattern

In case of undiagnosed, persistent, or recurrent abnormal vaginal bleeding, appropriate measures should be conducted to rule out malignancy.

5.3 Ectopic Pregnancies

As with all progestin-only contraceptive products, be alert to the possibility of an ectopic pregnancy among women using IMPLANON who become pregnant or complain of lower abdominal pain. Although ectopic pregnancies are uncommon among women using IMPLANON, a pregnancy that occurs in a woman using IMPLANON may be more likely to be ectopic than a pregnancy occurring in a woman using no contraception.

5.4 Thrombotic and Other Vascular Events

The use of combination hormonal contraceptives (progestin plus estrogen) increases the risk of vascular events, including arterial events (strokes and myocardial infarctions) or deep venous thrombotic events (venous thromboembolism, deep venous

thrombosis, retinal vein thrombosis, and pulmonary embolism). IMPLANON is a progestin-only contraceptive. It is unknown whether this increased risk is applicable to etonogestrel alone. It is recommended, however, that women with risk factors known to increase the risk of venous and arterial thromboembolism be carefully assessed.

There have been postmarketing reports of serious arterial and venous thromboembolic events, including cases of pulmonary emboli (some fatal), deep vein thrombosis, myocardial infarction, and strokes, in women using IMPLANON. IMPLANON should be removed in the event of a thrombosis.

Due to the risk of thromboembolism associated with pregnancy and immediately following delivery, IMPLANON should not be used prior to 21 days postpartum. Women with a history of thromboembolic disorders should be made aware of the possibility of a recurrence.

Evaluate for retinal vein thrombosis immediately if there is unexplained loss of vision, proptosis, diplopia, papilledema, or retinal vascular lesions.

Consider removal of the IMPLANON implant in case of long-term immobilization due to surgery or illness.

5.5 Ovarian Cysts

If follicular development occurs, atresia of the follicle is sometimes delayed, and the follicle may continue to grow beyond the size it would attain in a normal cycle. Generally, these enlarged follicles disappear spontaneously. On rare occasion, surgery may be required.

5.6 Carcinoma of the Breast and Reproductive Organs

Women who currently have or have had breast cancer should not use hormonal contraception because breast cancer may be hormonally sensitive [see *Contraindications (4)*]. Some studies suggest that the use of combination hormonal contraceptives might increase the incidence of breast cancer; however, other studies have not confirmed such findings.

Some studies suggest that the use of combination hormonal contraceptives is associated with an increase in the risk of cervical cancer or intraepithelial neoplasia. However, there is controversy about the extent to which such findings are due to differences in sexual behavior and other factors.

Women with a family history of breast cancer or who develop breast nodules should be carefully monitored.

5.7 Liver Disease

Disturbances of liver function may necessitate the discontinuation of hormonal contraceptive use until markers of liver function return to normal. Remove IMPLANON if jaundice develops.

Hepatic adenomas are associated with combination hormonal contraceptives use. An estimate of the attributable risk is 3.3 cases per 100,000 for combination hormonal contraceptives users. It is not known whether a similar risk exists with progestin-only methods like IMPLANON.

The progestin in IMPLANON may be poorly metabolized in women with liver impairment. Use of IMPLANON in women with active liver disease or liver cancer is contraindicated [see *Contraindications (4)*].

5.8 Weight Gain

In clinical studies, mean weight gain in US IMPLANON users was 2.8 pounds after 1 year and 3.7 pounds after 2 years. How much of the weight gain was related to the implant is unknown. In studies, 2.3% of the users reported weight gain as the reason for having the implant removed.

5.9 Elevated Blood Pressure

Women with a history of hypertension-related diseases or renal disease should be discouraged from using hormonal contraception. For women with well-controlled hypertension, use of IMPLANON can be considered. Women with hypertension using IMPLANON should be closely monitored. If sustained hypertension develops during the use of IMPLANON, or if a significant increase in blood pressure does not respond adequately to antihypertensive therapy, IMPLANON should be removed.

5.10 Gallbladder Disease

Studies suggest a small increased relative risk of developing gallbladder disease among combination hormonal contraceptive users. It is not known whether a similar risk exists with progestin-only methods like IMPLANON.

5.11 Carbohydrate and Lipid Metabolic Effects

Use of IMPLANON may induce mild insulin resistance and small changes in glucose concentrations of unknown clinical significance. Carefully monitor prediabetic and diabetic women using IMPLANON.

Women who are being treated for hyperlipidemia should be followed closely if they elect to use IMPLANON. Some progestins may elevate LDL levels and may render the control of hyperlipidemia more difficult.

5.12 Depressed Mood

Women with a history of depressed mood should be carefully observed. Consideration should be given to removing IMPLANON in patients who become significantly depressed.

5.13 Return to Ovulation

In clinical trials with IMPLANON, the etonogestrel levels in blood decreased below sensitivity of the assay by one week after removal of the implant. In addition, pregnancies were observed to occur as early as 7 to 14 days after removal. Therefore, a woman should re-start contraception immediately after removal of the implant if continued contraceptive protection is desired.

5.14 Fluid Retention

Hormonal contraceptives may cause some degree of fluid retention. They should be prescribed with caution, and only with careful monitoring, in patients with conditions which might be aggravated by fluid retention. It is unknown if IMPLANON causes fluid retention.

5.15 Contact Lenses

Contact lens wearers who develop visual changes or changes in lens tolerance should be assessed by an ophthalmologist.

5.16 Monitoring

A woman who is using IMPLANON should have a yearly visit with her healthcare provider for a blood pressure check and for other indicated health care.

5.17 Drug-Laboratory Test Interactions

Sex hormone-binding globulin concentrations may be decreased for the first 6 months after IMPLANON insertion followed by a gradual recovery. Thyroxine concentrations may initially be slightly decreased followed by gradual recovery to baseline.

6 ADVERSE REACTIONS

The following adverse reactions reported with the use of hormonal contraception are discussed elsewhere in the labeling:

- Changes in Menstrual Bleeding Patterns [see Warnings and Precautions (5.2)]
- Ectopic Pregnancies [see Warnings and Precautions (5.3)]
- Thrombotic and Other Vascular Events [see Warnings and Precautions (5.4)]
- Liver Disease [see Warnings and Precautions (5.7)]

6.1 Clinical Trials Experience

Because clinical trials are conducted under widely varying conditions, adverse reaction rates observed in the clinical trials of a drug cannot be directly compared to rates in the clinical trials of another drug and may not reflect the rates observed in practice.

In clinical trials including 942 women who were evaluated for safety, change in menstrual bleeding patterns (irregular menses) was the most common adverse reaction causing discontinuation of use of IMPLANON (11.1% of women).

Adverse reactions that resulted in a rate of discontinuation of $\geq 1\%$ are shown in Table 3.

Table 3: Adverse Reactions Leading to Discontinuation of Treatment in 1% or More of Subjects in Clinical Trials of IMPLANON

Adverse Reactions	All Studies N = 942
Bleeding Irregularities*	11.1%
Emotional Lability†	2.3%
Weight Increase	2.3%
Headache	1.6%
Acne	1.3%
Depression‡	1.0%

* Includes "frequent", "heavy", "prolonged", "spotting", and other patterns of bleeding irregularity.

† Among US subjects (N=330), 6.1% experienced emotional lability that led to discontinuation.

‡ Among US subjects (N=330), 2.4% experienced depression that led to discontinuation.

Other adverse reactions that were reported by at least 5% of subjects in clinical trials of IMPLANON are listed in Table 4.

Table 4: Common Adverse Reactions Reported by $\geq 5\%$ of Subjects in Clinical Trials with IMPLANON

Adverse Reaction	All Studies N=942
Headache	24.9%
Vaginitis	14.5%
Weight increase	13.7%
Acne	13.5%
Breast pain	12.8%
Abdominal pain	10.9%
Pharyngitis	10.5%
Leukorrhea	9.6%
Influenza-like symptoms	7.6%
Dizziness	7.2%
Dysmenorrhea	7.2%
Back pain	6.8%
Emotional lability	6.5%
Nausea	6.4%
Pain	5.6%
Nervousness	5.6%
Depression	5.5%
Hypersensitivity	5.4%
Insertion site pain	5.2%

Implant site complications were reported by 3.6% of subjects during any of the assessments in clinical trials. Pain was the most frequent implant site complication, reported during and/or after insertion, occurring in 2.9% of subjects. Additionally, hematoma, redness, and swelling were reported by 0.1%, 0.3%, and 0.3% of patients, respectively [see *Warnings and Precautions* (5.1)].

6.2 Postmarketing Experience

The following additional adverse reactions have been identified during post-approval use of IMPLANON. Because these reactions are reported voluntarily from a population of uncertain size, it is not possible to reliably estimate their frequency or establish a causal relationship to drug exposure.

Gastrointestinal disorders: constipation, diarrhea, flatulence, vomiting.

General disorders and administration site conditions: edema, fatigue, implant site reaction, pyrexia.

Immune system disorders: anaphylactic reactions

Infections and infestations: rhinitis, urinary tract infection.

Investigations: clinically relevant rise in blood pressure, weight decreased.

Metabolism and nutrition disorders: increased appetite.

Musculoskeletal and connective tissue disorders: arthralgia, musculoskeletal pain, myalgia.

Nervous system disorders: convulsions, migraine, somnolence.

Pregnancy, puerperium and perinatal conditions: ectopic pregnancy.

Psychiatric disorders: anxiety, insomnia, libido decreased.

Renal and urinary disorders: dysuria.

Reproductive system and breast disorders: breast discharge, breast enlargement, ovarian cyst, pruritus genital, vulvovaginal discomfort.

Skin and subcutaneous tissue disorders: angioedema, aggravation of angioedema and/or aggravation of hereditary angioedema, alopecia, chloasma, hypertrichosis, pruritus, rash, seborrhea, urticaria.

Vascular disorders: hot flush.

Complications related to insertion or removal of the implant reported include: bruising, slight local irritation, pain or itching, fibrosis at the implant site, paresthesia or paresthesia-like events, scarring and abscess.

7 DRUG INTERACTIONS

7.1 Changes in Contraceptive Effectiveness Associated with Coadministration of Other Products

Drugs or herbal products that induce enzymes, including CYP3A4, that metabolize progestins may decrease the plasma concentrations of progestins, and may decrease the effectiveness of IMPLANON. In women on long-term treatment with hepatic enzyme inducing drugs, it is recommended to remove the implant and to advise a contraceptive method that is unaffected by the interacting drug.

Some of these drugs or herbal products that induce enzymes, including CYP3A4, include:

- barbiturates
- bosentan
- carbamazepine
- felbamate
- griseofulvin
- oxcarbazepine
- phenytoin
- rifampin
- St. John's wort
- Topiramate

HIV Antiretrovirals

Significant changes (increase or decrease) in the plasma levels of progestin have been noted in some cases of co-administration with HIV protease inhibitors or with non-nucleoside reverse transcriptase inhibitors. Consult the labeling of all concurrently-used drugs to obtain further information about interactions with hormonal contraceptives or the potential for enzyme alterations.

7.2 Increase in Plasma Concentrations of Etonogestrel Associated with Coadministered Drugs

CYP3A4 inhibitors such as itraconazole or ketoconazole may increase plasma concentrations of etonogestrel.

7.3 Changes in Plasma Concentrations of Coadministered Drugs

Hormonal contraceptives may affect the metabolism of other drugs. Consequently, plasma concentrations may either increase (for example, cyclosporin) or decrease (for example, lamotrigine). Consult the labeling of all concurrently-used drugs to obtain further information about interactions with hormonal contraceptives or the potential for enzyme alterations.

8 USE IN SPECIFIC POPULATIONS

8.1 Pregnancy

IMPLANON is not indicated for use during pregnancy [see *Contraindications (4)*].

Teratology studies have been performed in rats and rabbits using oral administration up to 390 and 790 times the human IMPLANON dose (based upon body surface) and revealed no evidence of fetal harm due to etonogestrel exposure.

Studies have revealed no increased risk of birth defects in women who have used combination oral contraceptives before pregnancy or during early pregnancy. There is no evidence that the risk associated with IMPLANON is different from that of combination oral contraceptives.

IMPLANON should be removed if maintaining a pregnancy.

8.3 Nursing Mothers

Based on limited clinical data, IMPLANON may be used during breastfeeding after the fourth postpartum week. Use of IMPLANON before the fourth postpartum week has not been studied. Small amounts of etonogestrel are excreted in breast milk. During the first months after insertion of IMPLANON, when maternal blood levels of etonogestrel are highest, about 100 ng of etonogestrel may be ingested by the child per day based on an average daily milk ingestion of 658 mL. Based on daily milk ingestion of 150 mL/kg, the mean daily infant etonogestrel dose one month after insertion of IMPLANON is about 2.2% of the weight-adjusted maternal daily dose, or about 0.2% of the estimated absolute maternal daily dose. The health of breast-fed infants whose mothers began using IMPLANON during the fourth to eighth week postpartum (n=38) was evaluated in a comparative study with infants of mothers using a non-hormonal IUD (n=33). They were breast-fed for a mean duration of 14 months and followed up to 36 months of age. No significant effects and no differences between the groups were observed on the physical and psychomotor development of these infants. No differences between groups in the production or quality of breast milk were detected.

Healthcare providers should discuss both hormonal and non-hormonal contraceptive options, as steroids may not be the initial choice for these patients.

8.4 Pediatric Use

Safety and efficacy of IMPLANON have been established in women of reproductive age. Safety and efficacy of IMPLANON are expected to be the same for postpubertal adolescents. However, no clinical studies have been conducted in women less than 18 years of age. Use of this product before menarche is not indicated.

8.5 Geriatric Use

This product has not been studied in women over 65 years of age and is not indicated in this population.

8.6 Hepatic Impairment

No studies were conducted to evaluate the effect of hepatic disease on the disposition of IMPLANON. The use of IMPLANON in women with active liver disease is contraindicated [see *Contraindications (4)*].

8.7 Renal Impairment

No studies were conducted to evaluate the effect of renal disease on the disposition of IMPLANON.

8.8 Overweight Women

The effectiveness of IMPLANON in women who weighed more than 130% of their ideal body weight has not been defined because such women were not studied in clinical trials. Serum concentrations of etonogestrel are inversely related to body weight and decrease with time after implant insertion. It is therefore possible that IMPLANON may be less effective in overweight women, especially in the presence of other factors that decrease serum etonogestrel concentrations such as concomitant use of hepatic enzyme inducers.

10 OVERDOSAGE

Overdosage may result if more than 1 implant is inserted. In case of suspected overdose, the implant should be removed.

11 DESCRIPTION

IMPLANON (etonogestrel implant) is a progestin-only, soft, flexible implant preloaded in a sterile, disposable applicator for subdermal use. The implant is off-white, non-biodegradable and 4 cm in length with a diameter of 2 mm (see Figure 22). Each implant consists of an ethylene vinylacetate (EVA) copolymer core, containing 68 mg of the synthetic progestin etonogestrel, surrounded by an EVA copolymer skin. Once inserted subdermally, the release rate is 60 to 70 mcg/day in Week 5 to 6 and decreases to approximately 35 to 45 mcg/day at the end of the first year, to approximately 30 to 40 mcg/day at the end of the second year, and then to approximately 25 to 30 mcg/day at the end of the third year. IMPLANON is a progestin-only contraceptive and does not contain estrogen. IMPLANON does not contain latex and is not radio-opaque.

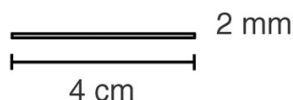

Figure 22 (Not to scale)

Etonogestrel [13-Ethyl-17-hydroxy-11-methylene-18,19-dinor-17 α -pregn-4-en-20-yn-3-one], structurally derived from 19-nortestosterone, is the synthetic biologically active metabolite of the synthetic progestin desogestrel. It has a molecular weight of 324.46 and the following structural formula (Figure 23).

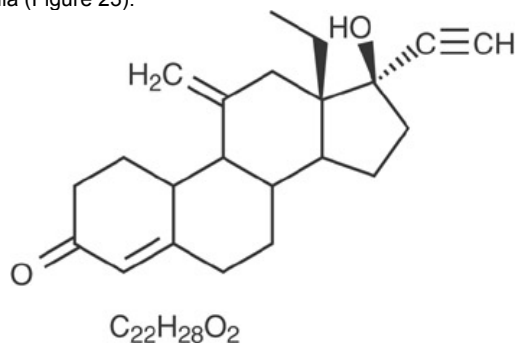

Figure 23

12 CLINICAL PHARMACOLOGY

12.1 Mechanism of Action

The contraceptive effect of IMPLANON is achieved by suppression of ovulation, increased viscosity of the cervical mucus, and alterations in the endometrium.

12.2 Pharmacodynamics

Exposure-response relationships of IMPLANON are unknown.

12.3 Pharmacokinetics

Absorption

After subdermal insertion of the etonogestrel implant, etonogestrel is released into the circulation and is approximately 100% bioavailable.

The mean peak serum concentrations in 3 pharmacokinetic studies ranged between 781 and 894 pg/mL and were reached within the first few weeks after insertion. The mean serum etonogestrel concentration decreases gradually over time declining to 192 to 261 pg/mL at 12 months (n=41), 154 to 194 pg/mL at 24 months (n=35), and 156 to 177 pg/mL at 36 months (n=17).

The pharmacokinetic profile of IMPLANON from 1 of 3 pharmacokinetic studies is shown in Figure 24.

Figure 24 Mean Serum Concentration-time Profile of Etonogestrel During 2 Years of IMPLANON Use and After Removal in 20 Healthy Women

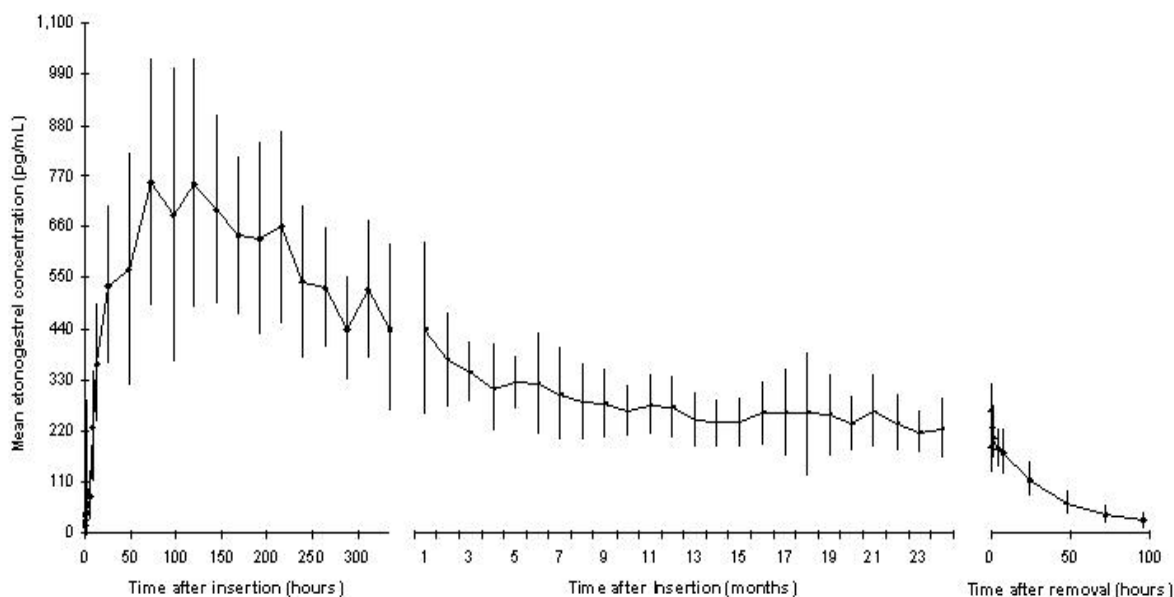

Figure 24

Distribution

The apparent volume of distribution averages about 201 L. Etonogestrel is approximately 32% bound to sex hormone binding globulin (SHBG) and 66% bound to albumin in blood.

Metabolism

In vitro data shows that etonogestrel is metabolized in liver microsomes by the cytochrome P450 3A4 isoenzyme. The biological activity of etonogestrel metabolites is unknown.

Excretion

The elimination half-life of etonogestrel is approximately 25 hours. Excretion of etonogestrel and its metabolites, either as free steroid or as conjugates, is mainly in urine and to a lesser extent in feces. After removal of the implant, etonogestrel concentrations decreased below sensitivity of the assay by 1 week.

13 NONCLINICAL TOXICOLOGY

13.1 Carcinogenesis, Mutagenesis, Impairment of Fertility

In a 24-month carcinogenicity study in rats with subdermal implants releasing 10 and 20 mcg etonogestrel per day (equal to approximately 1.8-3.6 times the systemic steady state exposure in women using IMPLANON), no drug-related carcinogenic potential was observed. Etonogestrel was not genotoxic in the *in vitro* Ames/Salmonella reverse mutation assay, the chromosomal aberration assay in Chinese hamster ovary cells or in the *in vivo* mouse micronucleus test. Fertility returned after withdrawal from treatment.

14 CLINICAL STUDIES

14.1 Pregnancy

In clinical trials of up to 3 years duration that involved 923 subjects, 18 - 40 years of age at entry, and 1,756 women-years of IMPLANON use, the total exposures expressed as 28-day cycle equivalents by study year were:

- Year 1: 10,866 cycles
- Year 2: 8,581 cycles
- Year 3: 3,442 cycles

The clinical trials excluded women who:

- Weighed more than 130% of their ideal body weight
- Were chronically taking medications that induce liver enzymes

In the subgroup of women 18 to 35 years of age at entry, 6 pregnancies during 20,648 cycles of use were reported. Two pregnancies occurred in each of Years 1, 2 and 3. Each conception was likely to have occurred shortly before or within 2 weeks after IMPLANON removal. With these 6 pregnancies, the cumulative Pearl Index was 0.38 pregnancies per 100 women-years of use.

14.2 Return to Ovulation

In clinical trials with IMPLANON, the etonogestrel levels in blood decreased below sensitivity of the assay by one week after removal of the implant. In addition, pregnancies were observed to occur as early as 7 to 14 days after removal. Therefore, a woman should re-start contraception immediately after removal of the implant if continued contraceptive protection is desired.

16 HOW SUPPLIED/STORAGE AND HANDLING

16.1 How Supplied

One IMPLANON package consists of a single implant containing 68 mg etonogestrel that is 4 cm in length and 2 mm in diameter, which is pre-loaded in the needle of a disposable applicator. The sterile applicator containing the implant is packed in a blister pack.

NDC 0052-0272-01

16.2 Storage and Handling

Store IMPLANON (etonogestrel implant) at 25°C (77°F); excursions permitted to 15°-30°C (59°-86°F) [see USP Controlled Room Temperature]. Protect from light. Avoid storing IMPLANON in direct sunlight or at temperatures above 30°C (86°F).

17 PATIENT COUNSELING INFORMATION

“See FDA-Approved Patient Labeling (Patient Information)”

- Counsel women about the insertion and removal procedure of the IMPLANON implant. Provide the woman with a copy of the Patient Labeling and ensure that she understands the information in the Patient Labeling before insertion and removal. A USER CARD and consent form are included in the packaging. Have the woman complete a consent form and retain it in your records. The USER CARD should be filled out and given to the patient after insertion of the IMPLANON implant so that she will have a record of the location of the implant in the upper arm and when it should be removed.
- Counsel women that IMPLANON does not protect against HIV infection (AIDS) or other sexually transmitted diseases.
- Counsel women that the use of IMPLANON may be associated with changes in their normal menstrual bleeding patterns so that they know what to expect.

FDA-Approved Patient Labeling

See the full patient product information for IMPLANON.

Manufactured for: Merck Sharp & Dohme Corp., a subsidiary of
 **MERCK & CO., INC.**, Whitehouse Station, NJ 08889, USA

Manufactured by: N.V. Organon, Oss, The Netherlands, a subsidiary of **Merck & Co., Inc.**, Whitehouse Station, NJ 08889, USA

For patent information: www.merck.com/product/patent/home.html

Copyright © 2006, 2009, 2012 Merck Sharp & Dohme B.V., a subsidiary of **Merck & Co., Inc.**
All rights reserved.

Revised: 07/2014

FDA-Approved Patient Labeling
IMPLANON® (etonogestrel implant)
Subdermal Use

IMPLANON® does not protect against HIV infection (the virus that causes AIDS) or other sexually transmitted diseases. Read this Patient Information leaflet carefully before you decide if IMPLANON is right for you. This information does not take the place of talking with your healthcare provider. If you have any questions about IMPLANON, ask your healthcare provider.

What is IMPLANON?

IMPLANON is a hormone-releasing birth control implant for use by women to prevent pregnancy for up to 3 years. The implant is a flexible plastic rod about the size of a matchstick that contains a progestin hormone called etonogestrel. Your healthcare provider will insert the implant just under the skin of the inner side of your upper arm. You can use a single IMPLANON implant for up to 3 years. IMPLANON does not contain estrogen.



What if I need birth control for more than 3 years?

The IMPLANON implant must be removed after 3 years. Your healthcare provider can insert a new implant under your skin after taking out the old one if you choose to continue using IMPLANON for birth control.

What if I change my mind about birth control and want to stop using IMPLANON before 3 years?

Your healthcare provider can remove the implant at any time. You may become pregnant as early as the first week after removal of the implant. If you do not want to get pregnant after your healthcare provider removes the IMPLANON implant, you should start another birth control method right away.

How does IMPLANON work?

IMPLANON prevents pregnancy in several ways. The most important way is by stopping the release of an egg from your ovary. IMPLANON also thickens the mucus in your cervix and this change may keep sperm from reaching the egg. IMPLANON also changes the lining of your uterus.

How well does IMPLANON work?

When the IMPLANON implant is placed correctly, your chance of getting pregnant is very low (less than 1 pregnancy per 100 women who use IMPLANON for 1 year). It is not known if IMPLANON is as effective in very overweight women because studies did not include many overweight women.

The following chart shows the chance of getting pregnant for women who use different methods of birth control. Each box on the chart contains a list of birth control methods that are similar in effectiveness. The most effective methods are at the top of the chart. The box on the bottom of the chart shows the chance of getting pregnant for women who do not use birth control and are trying to get pregnant.

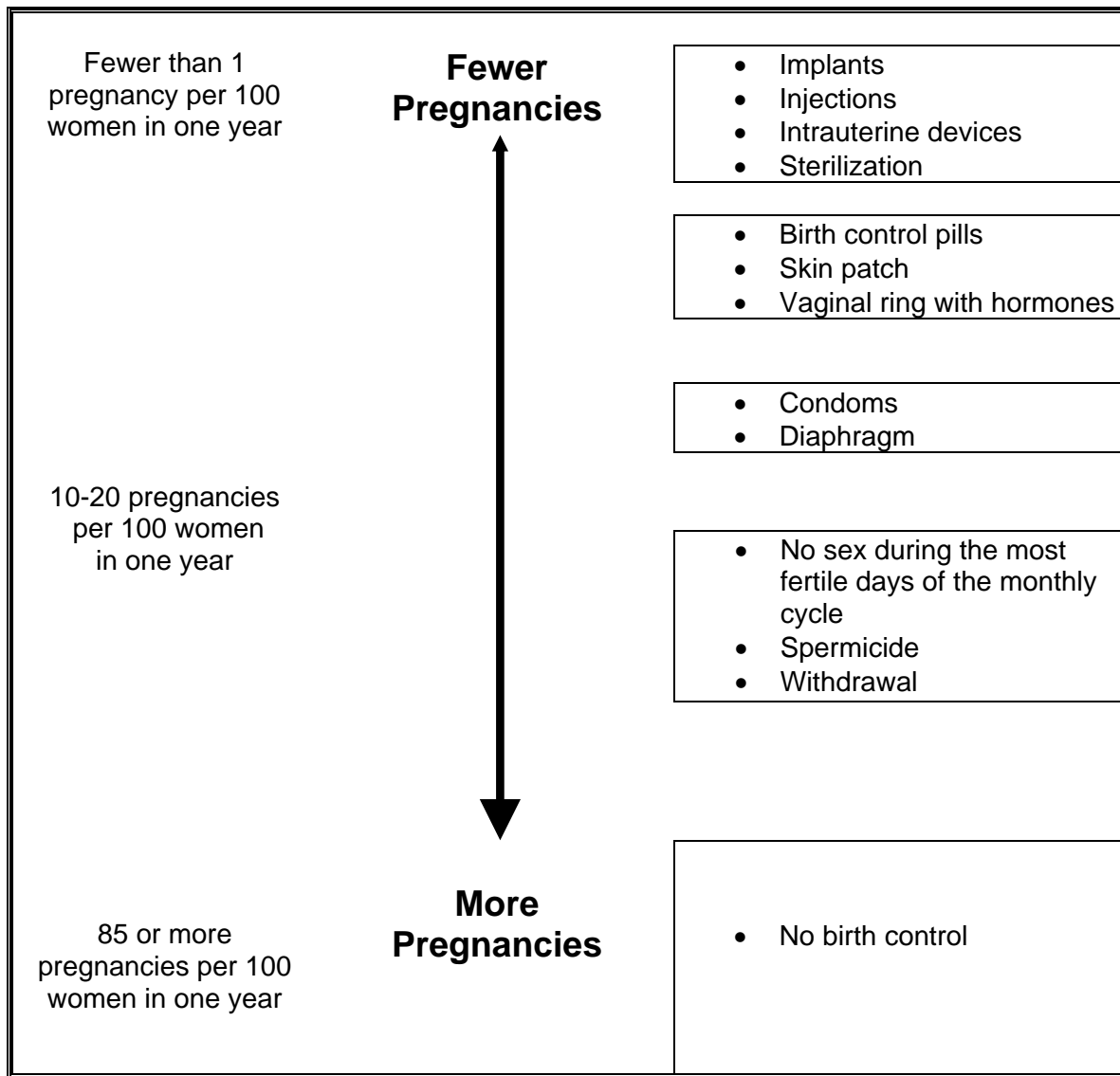

Who should not use IMPLANON?

Do not use IMPLANON if you

- Are pregnant or think you may be pregnant
- Have, or have had serious blood clots, such as blood clots in your legs (deep venous thrombosis), lungs (pulmonary embolism), eyes (total or partial blindness), heart (heart attack), or brain (stroke)
- Have liver disease or a liver tumor
- Have unexplained vaginal bleeding
- Have breast cancer or any other cancer that is sensitive to progestin (a female hormone), now or in the past
- Are allergic to anything in IMPLANON

Tell your healthcare provider if you have or have had any of the conditions listed above. Your healthcare provider can suggest a different method of birth control.

In addition, talk to your healthcare provider about using IMPLANON if you:

- Have diabetes
- Have high cholesterol or triglycerides
- Have headaches
- Have gallbladder or kidney problems
- Have a history of depressed mood
- Have high blood pressure
- Have an allergy to numbing medicines (anesthetics) or medicines used to clean your skin (antiseptics). These medicines will be used when the implant is placed into or removed from your arm.

Interaction with Other Medicines

Tell your healthcare provider about all the medicines you take, including prescription and non-prescription medicines, vitamins and herbal supplements. Certain medicines may make IMPLANON less effective, including:

- barbiturates
- bosentan
- carbamazepine
- felbamate
- griseofulvin
- oxcarbazepine
- phenytoin
- rifampin
- St. John's wort
- topiramate
- HIV medicines

Ask your healthcare provider if you are not sure if your medicine is one listed above.

If there are medicines that you have been taking for a long time, that make IMPLANON less effective, tell your healthcare provider. Your healthcare provider may remove the IMPLANON implant and recommend a birth control method that can be used effectively with these medicines.

When you are using IMPLANON, tell all of your healthcare providers that you have IMPLANON in place in your arm.

How is the IMPLANON implant placed and removed?

Your healthcare provider will place and remove the IMPLANON implant in a minor surgical procedure in his or her office. The implant is placed just under the skin on the inner side of your upper arm.

The timing of insertion is important. Your healthcare provider may:

- Perform a pregnancy test before inserting IMPLANON
- Schedule the insertion at a specific time of your menstrual cycle (for example, within the first days of your regular menstrual bleeding)

Immediately after the IMPLANON implant has been placed, you and your healthcare provider should check that the implant is in your arm by feeling for it.

If you and your healthcare provider cannot feel the IMPLANON implant, use a non-hormonal birth control method (such as condoms) until your healthcare provider confirms that the implant is in place. You may need special tests to check that the implant is in place or to help find the implant when it is time to take it out.

Your healthcare provider will cover the site where IMPLANON was placed with 2 bandages. Leave the top bandage on for 24 hours. Keep the smaller bandage clean, dry, and in place for 3 to 5 days.

You will be asked to review and sign a consent form prior to inserting the IMPLANON implant. You will also get a USER CARD to keep at home with your health records. Your healthcare provider will fill out the USER CARD with the date the implant was inserted and the date the implant is to be removed. Keep track of the date the implant is to be removed. Schedule an appointment with your healthcare provider to remove the implant on or before the removal date.

Be sure to have checkups as advised by your healthcare provider.

What are the most common side effects I can expect while using IMPLANON?

- **Changes in Menstrual Bleeding Patterns (menstrual periods)**

The most common side effect of IMPLANON is a change in your normal menstrual bleeding pattern. In studies, about one out of ten women stopped using the implant because of an unfavorable change in their bleeding pattern. You may experience longer or shorter bleeding during your periods or have no bleeding at all. The time between periods may vary, and in between periods you may also have spotting.

Talk with your healthcare provider right away if:

- You think you may be pregnant
- Your menstrual bleeding is heavy and prolonged

Besides changes in menstrual bleeding patterns, other frequent side effects that caused women to stop using the implant include:

- Mood swings
- Weight gain
- Headache
- Acne
- Depressed mood

Other common side effects include:

- Headache
- Vaginitis (inflammation of the vagina)
- Weight gain
- Acne
- Breast pain
- Viral infections such as sore throats or flu-like symptoms
- Stomach pain
- Painful periods
- Mood swings, nervousness, or depressed mood
- Back pain
- Nausea
- Dizziness
- Pain
- Pain at the site of insertion

This is not a complete list of possible side effects. For more information, ask your healthcare provider for advice about any side effects that concern you. You may report side effects to the FDA at 1-800-FDA-1088.

What are the possible risks of using IMPLANON?

- **Problems with Insertion and Removal**

The implant may not be placed in your arm at all due to a failed insertion or if the implant has fallen out of the needle. If this happens, you may become pregnant. Immediately after insertion, and with help from your healthcare provider, you should be able to feel the implant under your skin. If you can't feel the implant, tell your healthcare provider.

Removal of the implant may be very difficult or impossible because the implant is not where it should be. Special procedures, including surgery in the hospital, may be needed to remove the implant. If the implant is not removed, then the effects of IMPLANON will continue for a longer period of time.

Other problems related to insertion and removal are:

- Pain, irritation, swelling, or bruising at the insertion site
 - Scarring, including a thick scar called a keloid around the insertion site
 - Infection
 - Scar tissue may form around the implant making it difficult to remove
 - The implant may come out by itself. You may become pregnant if the implant comes out by itself. Use a back up birth control method and call your healthcare provider right away if the implant comes out.
 - The need for surgery in the hospital to remove the implant
 - Injury to nerves or blood vessels in your arm
 - The implant breaks making removal difficult
-
- **Ectopic Pregnancy**

If you become pregnant while using IMPLANON, you have a slightly higher chance that the pregnancy will be ectopic (occurring outside the womb) than do women who do not use birth control. Unusual vaginal bleeding or lower stomach (abdominal) pain may be a sign of ectopic pregnancy. Ectopic pregnancy is a medical emergency that often requires surgery. Ectopic pregnancies can cause serious internal bleeding, infertility, and even death. Call your healthcare provider right away if you think you are pregnant or have unexplained lower stomach (abdominal) pain.
-
- **Ovarian Cysts**

Cysts may develop on the ovaries and usually go away without treatment but sometimes surgery is needed to remove them.

- **Breast Cancer**

It is not known whether IMPLANON use changes a woman's risk for breast cancer. If you have breast cancer now, or have had it in the past, do not use IMPLANON because some breast cancers are sensitive to hormones.

- **Serious Blood Clots**

IMPLANON may increase your chance of serious blood clots, especially if you have other risk factors such as smoking. It is possible to die from a problem caused by a blood clot, such as a heart attack or a stroke.

Some examples of serious blood clots are blood clots in the:

- Legs (deep vein thrombosis)
- Lung (pulmonary embolism)
- Brain (stroke)
- Heart (heart attack)
- Eyes (total or partial blindness)

The risk of serious blood clots is increased in women who smoke. If you smoke and want to use IMPLANON, you should quit. Your healthcare provider may be able to help.

Tell your healthcare provider at least 4 weeks before if you are going to have surgery or will need to be on bed rest. You have an increased chance of getting blood clots during surgery or bed rest.

- **Other Risks**

A few women who use birth control that contains hormones may get:

- High blood pressure
- Gallbladder problems
- Rare cancerous or noncancerous liver tumors

When should I call my healthcare provider?

Call your healthcare provider right away if you have:

- Pain in your lower leg that does not go away

- Severe chest pain or heaviness in the chest
- Sudden shortness of breath, sharp chest pain, or coughing blood
- Symptoms of a severe allergic reaction, such as swollen face, tongue or throat; trouble breathing or swallowing
- Sudden severe headache unlike your usual headaches
- Weakness or numbness in your arm, leg, or trouble speaking
- Sudden partial or complete blindness
- Yellowing of your skin or whites of your eyes, especially with fever, tiredness, loss of appetite, dark colored urine, or light colored bowel movements
- Severe pain, swelling, or tenderness in the lower stomach (abdomen)
- Lump in your breast
- Problems sleeping, lack of energy, tiredness, or you feel very sad
- Heavy menstrual bleeding

What if I become pregnant while using IMPLANON?

You should see your healthcare provider right away if you think that you may be pregnant. It is important to remove the implant and make sure that the pregnancy is not ectopic (occurring outside the womb). Based on experience with other hormonal contraceptives, IMPLANON is not likely to cause birth defects.

Can I use IMPLANON when I am breastfeeding?

If you are breastfeeding your child, you may use IMPLANON if 4 weeks have passed since you had your baby. A small amount of the hormone contained in IMPLANON passes into your breast milk. The health of breast-fed children whose mothers were using the implant has been studied up to 3 years of age in a small number of children. No effects on the growth and development of the children were seen. If you are breastfeeding and want to use IMPLANON, talk with your healthcare provider for more information.

Additional Information

This Patient Information leaflet contains important information about IMPLANON. If you would like more information, talk with your healthcare provider. You can ask your healthcare provider for information about IMPLANON that is written for healthcare professionals. You may also call 1-877-IMPLANON (1-877-467-5266) or visit www.IMPLANON-USA.com

Manufactured for: Merck Sharp & Dohme Corp., a subsidiary of
 **MERCK & CO., INC.**, Whitehouse Station, NJ 08889, USA

Manufactured by: N.V. Organon, Oss, The Netherlands, a subsidiary of **Merck & Co., Inc.**,
Whitehouse Station, NJ 08889, USA

For patent information: www.merck.com/product/patent/home.html

Copyright © 2012 Merck Sharp & Dohme B.V., a subsidiary of **Merck & Co., Inc.**
All rights reserved.

Revised: 07/2014

HIGHLIGHTS OF PRESCRIBING INFORMATION

These highlights do not include all the information needed to use NEXPLANON safely and effectively. See full prescribing information for NEXPLANON.

NEXPLANON® (etonogestrel implant)

Radiopaque

Subdermal Use Only

Initial U.S. Approval: 2001

INDICATIONS AND USAGE

NEXPLANON is a progestin indicated for use by women to prevent pregnancy. (1)

DOSAGE AND ADMINISTRATION

Insert one NEXPLANON subdermally just under the skin at the inner side of the non-dominant upper arm. NEXPLANON must be removed no later than by the end of the third year. (2)

DOSAGE FORMS AND STRENGTHS

NEXPLANON consists of a single, radiopaque, rod-shaped implant, containing 68 mg etonogestrel, pre-loaded in the needle of a disposable applicator. (3)

CONTRAINDICATIONS

- Known or suspected pregnancy. (4)
- Current or past history of thrombosis or thromboembolic disorders. (4, 5.4)
- Liver tumors, benign or malignant, or active liver disease. (4, 5.7)
- Undiagnosed abnormal genital bleeding. (4, 5.2)
- Known or suspected breast cancer, personal history of breast cancer, or other progestin-sensitive cancer, now or in the past. (4, 5.6)
- Allergic reaction to any of the components of NEXPLANON. (4, 6)

WARNINGS AND PRECAUTIONS

- Insertion and removal complications: Pain, paresthesias, bleeding, hematoma, scarring or infection may occur. (5.1)
- Menstrual bleeding pattern: Counsel women regarding changes in bleeding frequency, intensity, or duration. (5.2)

- Ectopic pregnancies: Be alert to the possibility of an ectopic pregnancy in women using NEXPLANON who become pregnant or complain of lower abdominal pain. (5.3)
- Thrombotic and other vascular events: The NEXPLANON implant should be removed in the event of a thrombosis. (5.4)
- Liver disease: Remove the NEXPLANON implant if jaundice occurs. (5.7)
- Elevated blood pressure: The NEXPLANON implant should be removed if blood pressure rises significantly and becomes uncontrolled. (5.9)
- Carbohydrate and lipid metabolic effects: Monitor prediabetic and diabetic women using NEXPLANON. (5.11)

ADVERSE REACTIONS

Most common (≥10%) adverse reactions reported in clinical trials were change in menstrual bleeding pattern, headache, vaginitis, weight increase, acne, breast pain, abdominal pain, and pharyngitis. (6.1)

To report SUSPECTED ADVERSE REACTIONS, contact Merck Sharp & Dohme Corp., a subsidiary of Merck & Co., Inc., at 1-877-888-4231 or FDA at 1-800-FDA-1088 or www.fda.gov/medwatch.

DRUG INTERACTIONS

Drugs or herbal products that induce certain enzymes, such as CYP3A4, may decrease the effectiveness of progestin hormonal contraceptives or increase breakthrough bleeding. (7.1)

USE IN SPECIFIC POPULATIONS

- Pregnant women: NEXPLANON should be removed if maintaining a pregnancy. (8.1)
- Overweight women: NEXPLANON may become less effective in overweight women over time, especially in the presence of other factors that decrease etonogestrel concentrations, such as concomitant use of hepatic enzyme inducers. (8.8)

See 17 for PATIENT COUNSELING INFORMATION and FDA-approved patient labeling.

Revised: 07/2014

FULL PRESCRIBING INFORMATION: CONTENTS*

1 INDICATIONS AND USAGE

2 DOSAGE AND ADMINISTRATION

- 2.1 Initiating Contraception With NEXPLANON
- 2.2 Insertion of NEXPLANON
- 2.3 Removal of NEXPLANON
- 2.4 Replacing NEXPLANON

3 DOSAGE FORMS AND STRENGTHS

4 CONTRAINDICATIONS

5 WARNINGS AND PRECAUTIONS

- 5.1 Complications of Insertion and Removal
- 5.2 Changes in Menstrual Bleeding Patterns
- 5.3 Ectopic Pregnancies
- 5.4 Thrombotic and Other Vascular Events
- 5.5 Ovarian Cysts
- 5.6 Carcinoma of the Breast and Reproductive Organs
- 5.7 Liver Disease
- 5.8 Weight Gain
- 5.9 Elevated Blood Pressure
- 5.10 Gallbladder Disease
- 5.11 Carbohydrate and Lipid Metabolic Effects
- 5.12 Depressed Mood
- 5.13 Return to Ovulation
- 5.14 Fluid Retention
- 5.15 Contact Lenses
- 5.16 Monitoring
- 5.17 Drug-Laboratory Test Interactions

6 ADVERSE REACTIONS

- 6.1 Clinical Trials Experience
- 6.2 Postmarketing Experience

7 DRUG INTERACTIONS

- 7.1 Changes in Contraceptive Effectiveness Associated With Coadministration of Other Products

7.2 Increase in Plasma Concentrations of Etonogestrel Associated With Coadministered Drugs

7.3 Changes in Plasma Concentrations of Coadministered Drugs

8 USE IN SPECIFIC POPULATIONS

- 8.1 Pregnancy
- 8.3 Nursing Mothers
- 8.4 Pediatric Use
- 8.5 Geriatric Use
- 8.6 Hepatic Impairment
- 8.7 Renal Impairment
- 8.8 Overweight Women

10 OVERDOSAGE

11 DESCRIPTION

12 CLINICAL PHARMACOLOGY

- 12.1 Mechanism of Action
- 12.2 Pharmacodynamics
- 12.3 Pharmacokinetics

13 NONCLINICAL TOXICOLOGY

- 13.1 Carcinogenesis, Mutagenesis, Impairment of Fertility

14 CLINICAL STUDIES

- 14.1 Pregnancy
- 14.2 Return to Ovulation
- 14.3 Implant Insertion and Removal Characteristics

16 HOW SUPPLIED/STORAGE AND HANDLING

- 16.1 How Supplied
- 16.2 Storage and Handling

17 PATIENT COUNSELING INFORMATION

*Sections or subsections omitted from the full prescribing information are not listed.

FULL PRESCRIBING INFORMATION

1 INDICATIONS AND USAGE

NEXPLANON® is indicated for use by women to prevent pregnancy.

2 DOSAGE AND ADMINISTRATION

The efficacy of NEXPLANON does not depend on daily, weekly or monthly administration.

All healthcare providers should receive instruction and training prior to performing insertion and/or removal of NEXPLANON.

A single NEXPLANON implant is inserted subdermally in the upper arm. To reduce the risk of neural or vascular injury, the implant should be inserted at the inner side of the non-dominant upper arm about 8-10 cm (3-4 inches) above the medial epicondyle of the humerus. The implant should be inserted subdermally just under the skin to avoid the large blood vessels and nerves that lie deeper in the subcutaneous tissues in the sulcus between the triceps and biceps muscles. NEXPLANON must be inserted by the expiration date stated on the packaging. NEXPLANON is a long-acting (up to 3 years), reversible, hormonal contraceptive method. The implant must be removed by the end of the third year and may be replaced by a new implant at the time of removal, if continued contraceptive protection is desired.

2.1 Initiating Contraception With NEXPLANON

IMPORTANT: Rule out pregnancy before inserting the implant.

Timing of insertion depends on the woman's recent contraceptive history, as follows:

- No preceding hormonal contraceptive use in the past month

NEXPLANON should be inserted between Day 1 (first day of menstrual bleeding) and Day 5 of the menstrual cycle, even if the woman is still bleeding.

If inserted as recommended, back-up contraception is not necessary. If deviating from the recommended timing of insertion, the woman should be advised to use a barrier method until 7 days after insertion. If intercourse has already occurred, pregnancy should be excluded.

- Switching contraceptive method to NEXPLANON

Combination hormonal contraceptives:

NEXPLANON should preferably be inserted on the day after the last active tablet of the previous combined oral contraceptive or on the day of removal of the vaginal ring or transdermal patch. At the latest, NEXPLANON should be inserted on the day following the usual tablet-free, ring-free, patch-free or placebo tablet interval of the previous combined hormonal contraceptive.

If inserted as recommended, back-up contraception is not necessary. If deviating from the recommended timing of insertion, the woman should be advised to use a barrier method until 7 days after insertion. If intercourse has already occurred, pregnancy should be excluded.

Progestin-only contraceptives:

There are several types of progestin-only methods. NEXPLANON should be inserted as follows:

- **Injectable Contraceptives:** Insert NEXPLANON on the day the next injection is due.
- **Minipill:** A woman may switch to NEXPLANON on any day of the month. NEXPLANON should be inserted within 24 hours after taking the last tablet.
- **Contraceptive implant or intrauterine system (IUS):** Insert NEXPLANON on the same day the previous contraceptive implant or IUS is removed.

If inserted as recommended, back-up contraception is not necessary. If deviating from the recommended timing of insertion, the woman should be advised to use a barrier method until 7 days after insertion. If intercourse has already occurred, pregnancy should be excluded.

- Following abortion or miscarriage

- **First Trimester:** NEXPLANON should be inserted within 5 days following a first trimester abortion or miscarriage.
- **Second Trimester:** Insert NEXPLANON between 21 to 28 days following second trimester abortion or miscarriage.

If inserted as recommended, back-up contraception is not necessary. If deviating from the recommended timing of insertion, the woman should be advised to use a barrier method until 7 days after insertion. If intercourse has already occurred, pregnancy should be excluded.

- Postpartum

- Not Breastfeeding: NEXPLANON should be inserted between 21 to 28 days postpartum. If inserted as recommended, back-up contraception is not necessary. If deviating from the recommended timing of insertion, the woman should be advised to use a barrier method until 7 days after insertion. If intercourse has already occurred, pregnancy should be excluded.
- Breastfeeding: NEXPLANON should be inserted after the fourth postpartum week [see *Use in Specific Populations (8.3)*]. The woman should be advised to use a barrier method until 7 days after insertion. If intercourse has already occurred, pregnancy should be excluded.

2.2 Insertion of NEXPLANON

The basis for successful use and subsequent removal of NEXPLANON is a correct and carefully performed subdermal insertion of the single, rod-shaped implant in accordance with the instructions. Both the healthcare provider and the woman should be able to feel the implant under the skin after placement.

All healthcare providers performing insertions and/or removals of NEXPLANON should receive instructions and training prior to inserting or removing the implant. Information concerning the insertion and removal of NEXPLANON will be sent upon request free of charge [1-877-467-5266].

Preparation

Prior to inserting NEXPLANON carefully read the instructions for insertion as well as the full prescribing information.

Before insertion of NEXPLANON, the healthcare provider should confirm that:

- The woman is not pregnant nor has any other contraindication for the use of NEXPLANON [see *Contraindications (4)*].
- The woman has had a medical history and physical examination, including a gynecologic examination, performed.
- The woman understands the benefits and risks of NEXPLANON.
- The woman has received a copy of the Patient Labeling included in packaging.
- The woman has reviewed and completed a consent form to be maintained with the woman's chart.
- The woman does not have allergies to the antiseptic and anesthetic to be used during insertion.

Insert NEXPLANON under aseptic conditions.

The following equipment is needed for the implant insertion:

- An examination table for the woman to lie on
- Sterile surgical drapes, sterile gloves, antiseptic solution, sterile marker (optional)
- Local anesthetic, needles, and syringe
- Sterile gauze, adhesive bandage, pressure bandage

Insertion Procedure

Step 1. Have the woman lie on her back on the examination table with her non-dominant arm flexed at the elbow and externally rotated so that her wrist is parallel to her ear or her hand is positioned next to her head (Figure 1).

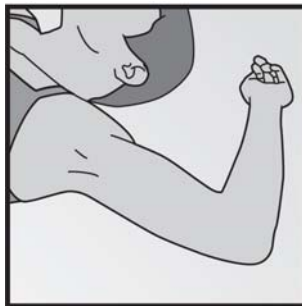

Figure 1

Step 2. Identify the insertion site, which is at the inner side of the non-dominant upper arm about 8-10 cm (3-4 inches) above the medial epicondyle of the humerus (Figure 2). **The implant should be inserted subdermally just under the skin to avoid the large blood vessels and nerves that lie deeper in the subcutaneous tissue in the sulcus between the triceps and biceps muscles** [see *Warnings and Precautions (5.1)*].

Step 3. Make two marks with a sterile marker: first, mark the spot where the etonogestrel implant will be inserted, and second, mark a spot a few centimeters proximal to the first mark (Figure 2). This second mark will later serve as a direction guide during insertion.

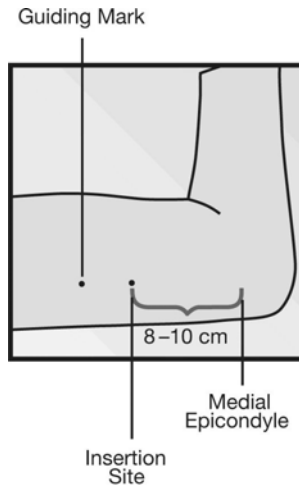

Figure 2

- Step 4. Clean the insertion site with an antiseptic solution.
- Step 5. Anesthetize the insertion area (for example, with anesthetic spray or by injecting 2 mL of 1% lidocaine just under the skin along the planned insertion tunnel).
- Step 6. Remove the sterile preloaded disposable NEXPLANON applicator carrying the implant from its blister. The applicator should not be used if sterility is in question.
- Step 7. Hold the applicator just above the needle at the textured surface area. Remove the transparent protection cap by sliding it horizontally in the direction of the arrow away from the needle (Figure 3). If the cap does not come off easily, the applicator should not be used. You can see the white colored implant by looking into the tip of the needle. **Do not touch the purple slider until you have fully inserted the needle subdermally, as it will retract the needle and prematurely release the implant from the applicator.**

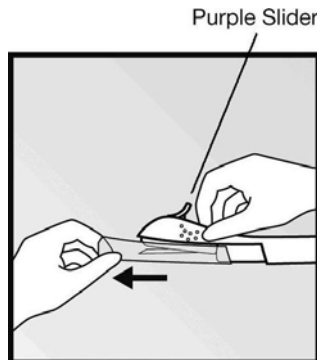

Figure 3

- Step 8. With your free hand, stretch the skin around the insertion site with thumb and index finger (Figure 4).

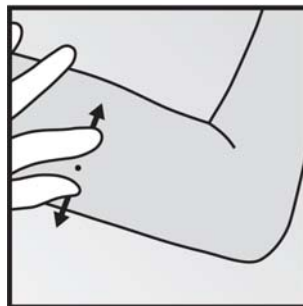

Figure 4

- Step 9. Puncture the skin with the tip of the needle angled about 30° (Figure 5).

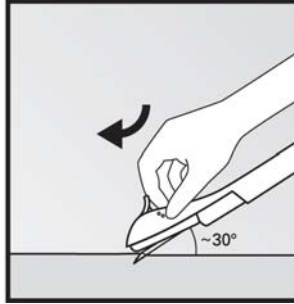

Figure 5

Step 10. Lower the applicator to a horizontal position. While lifting the skin with the tip of the needle (Figure 6), slide the needle to its full length. You may feel slight resistance but do not exert excessive force. **If the needle is not inserted to its full length, the implant will not be inserted properly.**

You can best see movement of the needle if you are seated and are looking at the applicator from the side and NOT from above. In this position, you can clearly see the insertion site and the movement of the needle just under the skin.

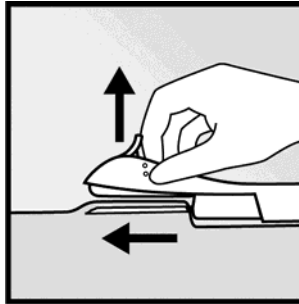

Figure 6

Step 11. Keep the applicator in the same position with the needle inserted to its full length. If needed, you may use your free hand to keep the applicator in the same position during the following procedure. Unlock the purple slider by pushing it slightly down. Move the slider fully back until it stops (Figure 7). The implant is now in its final subdermal position, and the needle is locked inside the body of the applicator. The applicator can now be removed. **If the applicator is not kept in the same position during this procedure or if the purple slider is not completely moved to the back, the implant will not be inserted properly.**

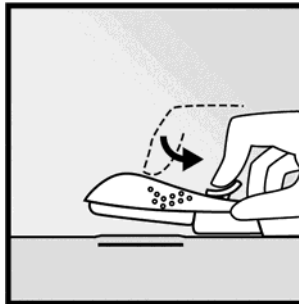

Figure 7

Step 12. **Always verify the presence of the implant in the woman's arm immediately after insertion by palpation.** By palpating both ends of the implant, you should be able to confirm the presence of the 4 cm rod (Figure 8).

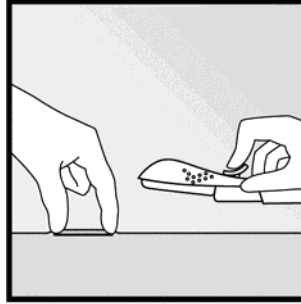

Figure 8

If you cannot feel the implant or are in doubt of its presence,

- Check the applicator. The needle should be fully retracted and only the purple tip of the obturator should be visible.
- Use other methods to confirm the presence of the implant. Suitable methods are: two-dimensional X-ray, X-ray computerized tomography (CT scan), ultrasound scanning (USS) with a high-frequency linear array transducer (10 MHz or greater) or magnetic resonance imaging (MRI). If these methods fail, call 1-877-467-5266 for information on the procedure for measuring etonogestrel blood levels.

Until the presence of the implant has been verified, the woman should be advised to use a non-hormonal contraceptive method, such as condoms.

Step 13. Place a small adhesive bandage over the insertion site. Request that the woman palpate the implant.

Step 14. Apply a pressure bandage with sterile gauze to minimize bruising. The woman may remove the pressure bandage in 24 hours and the small bandage over the insertion site after 3 to 5 days.

Step 15. Complete the USER CARD and give it to the woman to keep. Also, complete the PATIENT CHART LABEL and affix it to the woman's medical record.

Step 16. The applicator is for single use only and should be disposed in accordance with the Center for Disease Control and Prevention guidelines for handling of hazardous waste.

2.3 Removal of NEXPLANON

Preparation

Before initiating the removal procedure, the healthcare provider should carefully read the instructions for removal and consult the USER CARD and/or the PATIENT CHART LABEL for the location of the implant. The exact location of the implant in the arm should be verified by palpation. If the implant is not palpable, two-dimensional X-ray can be performed to verify its presence.

A non-palpable implant should always be first located prior to removal. Suitable methods for localization include: two-dimensional X-ray, X-ray computer tomography (CT), ultrasound scanning (USS) with a high-frequency linear array transducer (10 MHz or greater) or magnetic resonance imaging (MRI). If these imaging methods fail to locate the implant, etonogestrel blood level determination can be used for verification of the presence of the implant. For details on etonogestrel blood level determination, call 1-877-467-5266 for further instructions.

After localization of a non-palpable implant, consider conducting removal with ultrasound guidance.

There have been occasional reports of migration of the implant; usually this involves minor movement relative to the original position. This may complicate localization of the implant by palpation, CT, USS and/or MRI, and removal may require a larger incision and more time.

Exploratory surgery without knowledge of the exact location of the implant is strongly discouraged. Removal of deeply inserted implants should be conducted with caution in order to prevent injury to deeper neural or vascular structures in the arm and be performed by healthcare providers familiar with the anatomy of the arm.

Before removal of the implant, the healthcare provider should confirm that:

- The woman does not have allergies to the antiseptic or anesthetic to be used.

Remove the implant under aseptic conditions.

The following equipment is needed for removal of the implant:

- An examination table for the woman to lie on
- Sterile surgical drapes, sterile gloves, antiseptic solution, sterile marker (optional)
- Local anesthetic, needles, and syringe
- Sterile scalpel, forceps (straight and curved mosquito)
- Skin closure, sterile gauze, adhesive bandage and pressure bandages

Removal Procedure

Step 1. Clean the site where the incision will be made and apply an antiseptic. Locate the implant by palpation and mark the distal end (end closest to the elbow), for example, with a sterile marker (Figure 9).

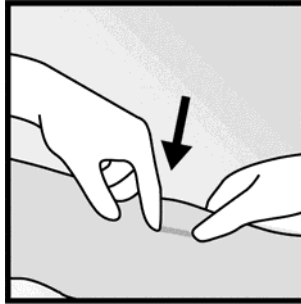

Figure 9

Step 2. Anesthetize the arm, for example, with 0.5 to 1 mL 1% lidocaine at the marked site where the incision will be made (Figure 10). Be sure to inject the local anesthetic under the implant to keep it close to the skin surface.

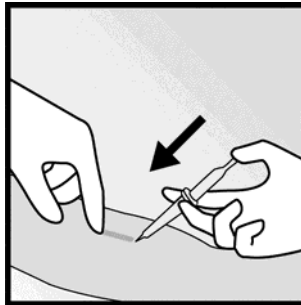

Figure 10

Step 3. Push down the proximal end of the implant (Figure 11) to stabilize it; a bulge may appear indicating the distal end of the implant. Starting at the distal tip of the implant, make a longitudinal incision of 2 mm towards the elbow.

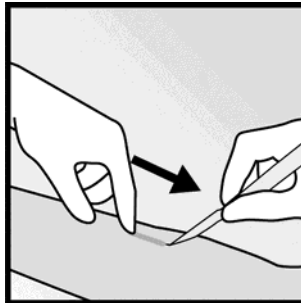

Figure 11

Step 4. Gently push the implant towards the incision until the tip is visible. Grasp the implant with forceps (preferably curved mosquito forceps) and gently remove the implant (Figure 12).

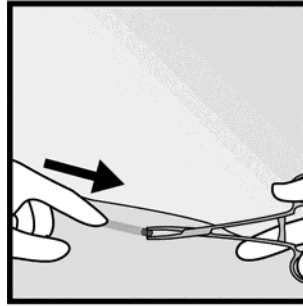

Figure 12

Step 5. If the implant is encapsulated, make an incision into the tissue sheath and then remove the implant with the forceps (Figures 13 and 14).

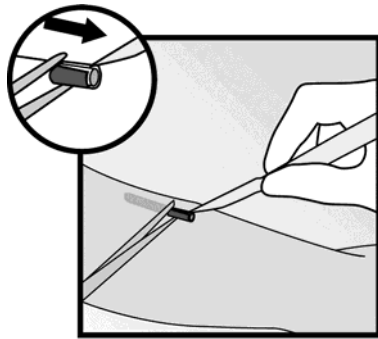

Figure 13

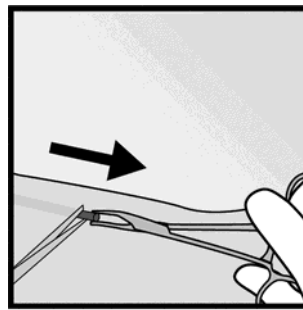

Figure 14

Step 6. If the tip of the implant does not become visible in the incision, gently insert a forceps into the incision (Figure 15). Flip the forceps over into your other hand (Figure 16).

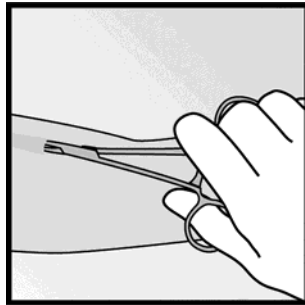

Figure 15

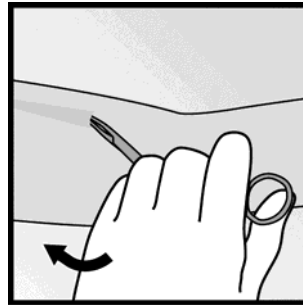

Figure 16

Step 7. With a second pair of forceps carefully dissect the tissue around the implant and grasp the implant (Figure 17). The implant can then be removed.

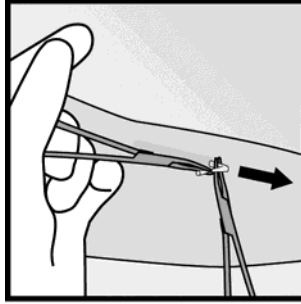

Figure 17

Step 8. Confirm that the entire implant, which is 4 cm long, has been removed by measuring its length. If a partial implant (less than 4 cm) is removed, the remaining piece should be removed by following the instructions in section 2.3. [See *Dosage and Administration (2.3)*.] If the woman would like to continue using NEXPLANON, a new implant may be inserted immediately after the old implant is removed using the same incision [see *Dosage and Administration (2.4)*].

Step 9. After removing the implant, close the incision with a steri-strip and apply an adhesive bandage.

Step 10. Apply a pressure bandage with sterile gauze to minimize bruising. The woman may remove the pressure bandage in 24 hours and the small bandage in 3 to 5 days.

2.4 Replacing NEXPLANON

Immediate replacement can be done after removal of the previous implant and is similar to the insertion procedure described in section 2.2 Insertion of NEXPLANON.

The new implant may be inserted in the same arm, and through the same incision from which the previous implant was removed. If the same incision is being used to insert a new implant, anesthetize the insertion site [for example, 2 mL lidocaine (1%)] applying it just under the skin along the 'insertion canal.'

Follow the subsequent steps in the insertion instructions [see *Dosage and Administration (2.2)*].

3 DOSAGE FORMS AND STRENGTHS

Single, white/off-white, soft, radiopaque, flexible, ethylene vinyl acetate (EVA) copolymer implant, 4 cm in length and 2 mm in diameter containing 68 mg etonogestrel and 15 mg of barium sulfate.

Single, white/off-white, soft, radiopaque, flexible, ethylene vinyl acetate (EVA) copolymer implant, 4 cm in length and 2 mm in diameter containing 68 mg etonogestrel, 15 mg of barium sulfate and 0.1 mg of magnesium stearate.

4 CONTRAINDICATIONS

NEXPLANON should not be used in women who have

- Known or suspected pregnancy
- Current or past history of thrombosis or thromboembolic disorders
- Liver tumors, benign or malignant, or active liver disease
- Undiagnosed abnormal genital bleeding
- Known or suspected breast cancer, personal history of breast cancer, or other progestin-sensitive cancer, now or in the past
- Allergic reaction to any of the components of NEXPLANON [see *Adverse Reactions (6)*]

5 WARNINGS AND PRECAUTIONS

The following information is based on experience with either the non-radiopaque etonogestrel implant (IMPLANON), other progestin-only contraceptives, or experience with combination (estrogen plus progestin) oral contraceptives.

5.1 Complications of Insertion and Removal

NEXPLANON should be inserted subdermally so that it will be palpable after insertion, and this should be confirmed by palpation immediately after insertion. Failure to insert NEXPLANON properly may go unnoticed unless it is palpated immediately after insertion. Undetected failure to insert the implant may lead to an unintended pregnancy. Complications related to insertion and removal procedures, such as pain, paresthesias, bleeding, hematoma, scarring or infection, may occur.

If NEXPLANON is inserted too deeply (intramuscular or in the fascia), neural or vascular injury may occur. To reduce the risk of neural or vascular injury, NEXPLANON should be inserted at the inner side of the non-dominant upper arm about 8-10 cm (3-4 inches) above the medial epicondyle of the humerus. NEXPLANON should be inserted subdermally just under the skin to avoid the large blood vessels and nerves that lie deeper in the subcutaneous tissues in the sulcus between the triceps and biceps muscles. Deep insertions of the non-radiopaque etonogestrel implant (IMPLANON) have been associated with paraesthesia (due to neural injury) and migration of the implant (due to intramuscular or fascial insertion), and in a very few cases with intravascular insertion. If infection develops at the insertion site, start suitable treatment. If the infection persists, the implant should be removed. Incomplete insertions or infections may lead to expulsion.

Implant removal may be difficult or impossible if the implant is not inserted correctly, is inserted too deeply, not palpable, encased in fibrous tissue, or has migrated. Deep insertions may lead to difficult localization of the implant and may also result in the need for a surgical procedure in an operating room in order to remove the implant. Exploratory surgery without knowledge of the exact location of the implant is strongly discouraged. Removal of deeply inserted implants should be conducted with caution in order to prevent injury to deeper neural or vascular structures in the arm and be performed by healthcare providers familiar with the anatomy of the arm. Failure to remove the implant may result in continued effects of etonogestrel, such as compromised fertility, ectopic pregnancy, or persistence or occurrence of a drug-related adverse event.

5.2 Changes in Menstrual Bleeding Patterns

After starting NEXPLANON, women are likely to have a change from their normal menstrual bleeding pattern. These may include changes in bleeding frequency (absent, less, more frequent or continuous), intensity (reduced or increased) or duration. In clinical trials of the non-radiopaque etonogestrel implant (IMPLANON), bleeding patterns ranged from amenorrhea (1 in 5 women) to frequent and/or prolonged bleeding (1 in 5 women). The bleeding pattern experienced during the first three months of NEXPLANON use is broadly predictive of the future bleeding pattern for many women. Women should be counseled regarding the bleeding pattern changes they may experience so that they know what to expect. Abnormal bleeding should be evaluated as needed to exclude pathologic conditions or pregnancy.

In clinical studies of the non-radiopaque etonogestrel implant, reports of changes in bleeding pattern were the most common reason for stopping treatment (11.1%). Irregular bleeding (10.8%) was the single most common reason women stopped treatment, while amenorrhea (0.3%) was cited less frequently. In these studies, women had an average of 17.7 days of bleeding or spotting every 90 days (based on 3,315 intervals of 90 days recorded by 780 patients). The percentages of patients having 0, 1-7, 8-21, or >21 days of spotting or bleeding over a 90-day interval while using the non-radiopaque etonogestrel implant are shown in Table 1.

Table 1: Percentages of Patients With 0, 1-7, 8-21, or >21 Days of Spotting or Bleeding Over a 90-Day Interval While Using the Non-Radiopaque Etonogestrel Implant (IMPLANON)

Total Days of Spotting or Bleeding	Percentage of Patients		
	Treatment Days 91-180 (N = 745)	Treatment Days 271-360 (N = 657)	Treatment Days 631-720 (N = 547)
0 Days	19%	24%	17%
1-7 Days	15%	13%	12%
8-21 Days	30%	30%	37%
>21 Days	35%	33%	35%

Bleeding patterns observed with use of the non-radiopaque etonogestrel implant for up to 2 years, and the proportion of 90-day intervals with these bleeding patterns, are summarized in Table 2.

Table 2: Bleeding Patterns Using the Non-Radiopaque Etonogestrel Implant (IMPLANON) During the First 2 Years of Use^A

BLEEDING PATTERNS	DEFINITIONS	% ^B
Infrequent	Less than three bleeding and/or spotting episodes in 90 days (excluding amenorrhea)	33.6
Amenorrhea	No bleeding and/or spotting in 90 days	22.2
Prolonged	Any bleeding and/or spotting episode lasting more than 14 days in 90 days	17.7
Frequent	More than 5 bleeding and/or spotting episodes in 90 days	6.7

^A Based on 3315 recording periods of 90 days duration in 780 women, excluding the first 90 days after implant insertion

^B % = Percentage of 90-day intervals with this pattern

In case of undiagnosed, persistent, or recurrent abnormal vaginal bleeding, appropriate measures should be conducted to rule out malignancy.

5.3 Ectopic Pregnancies

As with all progestin-only contraceptive products, be alert to the possibility of an ectopic pregnancy among women using NEXPLANON who become pregnant or complain of lower abdominal pain. Although ectopic pregnancies are uncommon among women using NEXPLANON, a pregnancy that occurs in a woman using NEXPLANON may be more likely to be ectopic than a pregnancy occurring in a woman using no contraception.

5.4 Thrombotic and Other Vascular Events

The use of combination hormonal contraceptives (progestin plus estrogen) increases the risk of vascular events, including arterial events (strokes and myocardial infarctions) or deep venous thrombotic events (venous thromboembolism, deep venous thrombosis, retinal vein thrombosis, and pulmonary embolism). NEXPLANON is a progestin-only contraceptive. It is unknown whether this increased risk is applicable to etonogestrel alone. It is recommended, however, that women with risk factors known to increase the risk of venous and arterial thromboembolism be carefully assessed.

There have been postmarketing reports of serious arterial and venous thromboembolic events, including cases of pulmonary emboli (some fatal), deep vein thrombosis, myocardial infarction, and strokes, in women using the non-radiopaque etonogestrel implant. NEXPLANON should be removed in the event of a thrombosis.

Due to the risk of thromboembolism associated with pregnancy and immediately following delivery, NEXPLANON should not be used prior to 21 days postpartum. Women with a history of thromboembolic disorders should be made aware of the possibility of a recurrence.

Evaluate for retinal vein thrombosis immediately if there is unexplained loss of vision, proptosis, diplopia, papilledema, or retinal vascular lesions.

Consider removal of the NEXPLANON implant in case of long-term immobilization due to surgery or illness.

5.5 Ovarian Cysts

If follicular development occurs, atresia of the follicle is sometimes delayed, and the follicle may continue to grow beyond the size it would attain in a normal cycle. Generally, these enlarged follicles disappear spontaneously. On rare occasion, surgery may be required.

5.6 Carcinoma of the Breast and Reproductive Organs

Women who currently have or have had breast cancer should not use hormonal contraception because breast cancer may be hormonally sensitive [see *Contraindications (4)*]. Some studies suggest that the use of combination hormonal contraceptives might increase the incidence of breast cancer; however, other studies have not confirmed such findings.

Some studies suggest that the use of combination hormonal contraceptives is associated with an increase in the risk of cervical cancer or intraepithelial neoplasia. However, there is controversy about the extent to which these findings are due to differences in sexual behavior and other factors.

Women with a family history of breast cancer or who develop breast nodules should be carefully monitored.

5.7 Liver Disease

Disturbances of liver function may necessitate the discontinuation of hormonal contraceptive use until markers of liver function return to normal. Remove NEXPLANON if jaundice develops.

Hepatic adenomas are associated with combination hormonal contraceptives use. An estimate of the attributable risk is 3.3 cases per 100,000 for combination hormonal contraceptives users. It is not known whether a similar risk exists with progestin-only methods like NEXPLANON.

The progestin in NEXPLANON may be poorly metabolized in women with liver impairment. Use of NEXPLANON in women with active liver disease or liver cancer is contraindicated [see *Contraindications (4)*].

5.8 Weight Gain

In clinical studies, mean weight gain in U.S. non-radiopaque etonogestrel implant (IMPLANON) users was 2.8 pounds after one year and 3.7 pounds after two years. How much of the weight gain was related to the non-radiopaque etonogestrel implant is unknown. In studies, 2.3% of the users reported weight gain as the reason for having the non-radiopaque etonogestrel implant removed.

5.9 Elevated Blood Pressure

Women with a history of hypertension-related diseases or renal disease should be discouraged from using hormonal contraception. For women with well-controlled hypertension, use of NEXPLANON can be considered. Women with hypertension using NEXPLANON should be closely monitored. If sustained hypertension develops during the use of NEXPLANON, or if a significant increase in blood pressure does not respond adequately to antihypertensive therapy, NEXPLANON should be removed.

5.10 Gallbladder Disease

Studies suggest a small increased relative risk of developing gallbladder disease among combination hormonal contraceptive users. It is not known whether a similar risk exists with progestin-only methods like NEXPLANON.

5.11 Carbohydrate and Lipid Metabolic Effects

Use of NEXPLANON may induce mild insulin resistance and small changes in glucose concentrations of unknown clinical significance. Carefully monitor prediabetic and diabetic women using NEXPLANON.

Women who are being treated for hyperlipidemia should be followed closely if they elect to use NEXPLANON. Some progestins may elevate LDL levels and may render the control of hyperlipidemia more difficult.

5.12 Depressed Mood

Women with a history of depressed mood should be carefully observed. Consideration should be given to removing NEXPLANON in patients who become significantly depressed.

5.13 Return to Ovulation

In clinical trials with the non-radiopaque etonogestrel implant (IMPLANON), the etonogestrel levels in blood decreased below sensitivity of the assay by one week after removal of the implant. In addition, pregnancies were observed to occur as early as 7 to 14 days after removal. Therefore, a woman should re-start contraception immediately after removal of the implant if continued contraceptive protection is desired.

5.14 Fluid Retention

Hormonal contraceptives may cause some degree of fluid retention. They should be prescribed with caution, and only with careful monitoring, in patients with conditions which might be aggravated by fluid retention. It is unknown if NEXPLANON causes fluid retention.

5.15 Contact Lenses

Contact lens wearers who develop visual changes or changes in lens tolerance should be assessed by an ophthalmologist.

5.16 Monitoring

A woman who is using NEXPLANON should have a yearly visit with her healthcare provider for a blood pressure check and for other indicated health care.

5.17 Drug-Laboratory Test Interactions

Sex hormone-binding globulin concentrations may be decreased for the first six months after NEXPLANON insertion followed by gradual recovery. Thyroxine concentrations may initially be slightly decreased followed by gradual recovery to baseline.

6 ADVERSE REACTIONS

The following adverse reactions reported with the use of hormonal contraception are discussed elsewhere in the labeling:

- Changes in Menstrual Bleeding Patterns [see Warnings and Precautions (5.2)]
- Ectopic Pregnancies [see Warnings and Precautions (5.3)]
- Thrombotic and Other Vascular Events [see Warnings and Precautions (5.4)]
- Liver Disease [see Warnings and Precautions (5.7)]

6.1 Clinical Trials Experience

Because clinical trials are conducted under widely varying conditions, adverse reaction rates observed in the clinical trials of a drug cannot be directly compared to rates in the clinical trials of another drug and may not reflect the rates observed in practice.

In clinical trials involving 942 women who were evaluated for safety, change in menstrual bleeding patterns (irregular menses) was the most common adverse reaction causing discontinuation of use of the non-radiopaque etonogestrel implant (IMPLANON) (11.1% of women).

Adverse reactions that resulted in a rate of discontinuation of $\geq 1\%$ are shown in Table 3.

Table 3: Adverse Reactions Leading to Discontinuation of Treatment in 1% or More of Subjects in Clinical Trials of the Non-Radiopaque Etonogestrel Implant (IMPLANON)

Adverse Reactions	All Studies N = 942
Bleeding Irregularities*	11.1%
Emotional Lability†	2.3%
Weight Increase	2.3%
Headache	1.6%
Acne	1.3%
Depression‡	1.0%

* Includes "frequent", "heavy", "prolonged", "spotting", and other patterns of bleeding irregularity.

† Among US subjects (N=330), 6.1% experienced emotional lability that led to discontinuation.

‡ Among US subjects (N=330), 2.4% experienced depression that led to discontinuation.

Other adverse reactions that were reported by at least 5% of subjects in the non-radiopaque etonogestrel implant clinical trials are listed in Table 4.

Table 4: Common Adverse Reactions Reported by ≥5% of Subjects in Clinical Trials With the Non-Radiopaque Etonogestrel Implant (IMPLANON)

Adverse Reactions	All Studies N = 942
Headache	24.9%
Vaginitis	14.5%
Weight increase	13.7%
Acne	13.5%
Breast pain	12.8%
Abdominal pain	10.9%
Pharyngitis	10.5%
Leukorrhea	9.6%
Influenza-like symptoms	7.6%
Dizziness	7.2%
Dysmenorrhea	7.2%
Back pain	6.8%
Emotional lability	6.5%
Nausea	6.4%
Pain	5.6%
Nervousness	5.6%
Depression	5.5%
Hypersensitivity	5.4%
Insertion site pain	5.2%

In a clinical trial of NEXPLANON, in which investigators were asked to examine the implant site after insertion, implant site reactions were reported in 8.6% of women. Erythema was the most frequent implant site complication, reported during and/or shortly after insertion, occurring in 3.3% of subjects. Additionally, hematoma (3.0%), bruising (2.0%), pain (1.0%), and swelling (0.7%) were reported.

6.2 Postmarketing Experience

The following additional adverse reactions have been identified during post-approval use of the non-radiopaque etonogestrel implant (IMPLANON). Because these reactions are reported voluntarily from a population of uncertain size, it is not possible to reliably estimate their frequency or establish a causal relationship to drug exposure.

Gastrointestinal disorders: constipation, diarrhea, flatulence, vomiting.

General disorders and administration site conditions: edema, fatigue, implant site reaction, pyrexia.

Immune system disorders: anaphylactic reactions.

Infections and infestations: rhinitis, urinary tract infection.

Investigations: clinically relevant rise in blood pressure, weight decreased.

Metabolism and nutrition disorders: increased appetite.

Musculoskeletal and connective tissue disorders: arthralgia, musculoskeletal pain, myalgia.

Nervous system disorders: convulsions, migraine, somnolence.

Pregnancy, puerperium and perinatal conditions: ectopic pregnancy.

Psychiatric disorders: anxiety, insomnia, libido decreased.

Renal and urinary disorders: dysuria.

Reproductive system and breast disorders: breast discharge, breast enlargement, ovarian cyst, pruritus genital, vulvovaginal discomfort.

Skin and subcutaneous tissue disorders: angioedema, aggravation of angioedema and/or aggravation of hereditary angioedema, alopecia, chloasma, hypertrichosis, pruritus, rash, seborrhea, urticaria.

Vascular disorders: hot flush.

Complications related to insertion or removal of the non-radiopaque etonogestrel implant reported include: bruising, slight local irritation, pain or itching, fibrosis at the implant site, paresthesia or paresthesia-like events, scarring and abscess.

7 DRUG INTERACTIONS

7.1 Changes in Contraceptive Effectiveness Associated With Coadministration of Other Products

Drugs or herbal products that induce enzymes, including CYP3A4, that metabolize progestins may decrease the plasma concentrations of progestins, and may decrease the effectiveness of NEXPLANON. In women on long-term treatment with hepatic enzyme inducing drugs, it is recommended to remove the implant and to advise a contraceptive method that is unaffected by the interacting drug.

Some of these drugs or herbal products that induce enzymes, including CYP3A4, include:

- barbiturates
- bosentan
- carbamazepine
- felbamate
- griseofulvin
- oxcarbazepine
- phenytoin
- rifampin
- St. John's wort
- topiramate

HIV Antiretrovirals

Significant changes (increase or decrease) in the plasma levels of progestin have been noted in some cases of co-administration with HIV protease inhibitors or with non-nucleoside reverse transcriptase inhibitors. Consult the labeling of all concurrently-used drugs to obtain further information about interactions with hormonal contraceptives or the potential for enzyme alterations.

7.2 Increase in Plasma Concentrations of Etonogestrel Associated With Coadministered Drugs

CYP3A4 inhibitors such as itraconazole or ketoconazole may increase plasma concentrations of etonogestrel.

7.3 Changes in Plasma Concentrations of Coadministered Drugs

Hormonal contraceptives may affect the metabolism of other drugs. Consequently, plasma concentrations may either increase (for example, cyclosporin) or decrease (for example, lamotrigine). Consult the labeling of all concurrently-used drugs to obtain further information about interactions with hormonal contraceptives or the potential for enzyme alterations.

8 USE IN SPECIFIC POPULATIONS

8.1 Pregnancy

NEXPLANON is not indicated for use during pregnancy [see *Contraindications (4)*].

Teratology studies have been performed in rats and rabbits using oral administration up to 390 and 790 times the human etonogestrel dose (based upon body surface), respectively, and revealed no evidence of fetal harm due to etonogestrel exposure.

Studies have revealed no increased risk of birth defects in women who have used combination oral contraceptives before pregnancy or during early pregnancy. There is no evidence that the risk associated with etonogestrel is different from that of combination oral contraceptives.

NEXPLANON should be removed if maintaining a pregnancy.

8.3 Nursing Mothers

Based on limited clinical data, NEXPLANON may be used during breastfeeding after the fourth postpartum week. Use of NEXPLANON before the fourth postpartum week has not been studied. Small amounts of etonogestrel are excreted in breast milk. During the first months after insertion of NEXPLANON, when maternal blood levels of etonogestrel are highest, about 100 ng of etonogestrel may be ingested by the child per day based on an average daily milk ingestion of 658 mL. Based on daily milk ingestion of 150 mL/kg, the mean daily infant etonogestrel dose one month after insertion of the non-radiopaque etonogestrel implant (IMPLANON) is about 2.2% of the weight-adjusted maternal daily dose, or about 0.2% of the estimated absolute maternal daily dose. The health of breastfed infants whose mothers began using the non-radiopaque etonogestrel implant during the fourth to eighth week postpartum (n=38) was evaluated in a comparative study with infants of mothers using a non-hormonal IUD (n=33). They were breastfed for a mean duration of 14 months and followed up to 36 months of age. No significant effects and no differences between the groups were observed on the physical and psychomotor development of these infants. No differences between groups in the production or quality of breast milk were detected.

Healthcare providers should discuss both hormonal and non-hormonal contraceptive options, as steroids may not be the initial choice for these patients.

8.4 Pediatric Use

Safety and efficacy of NEXPLANON have been established in women of reproductive age. Safety and efficacy of NEXPLANON are expected to be the same for postpubertal adolescents. However, no clinical studies have been conducted in women less than 18 years of age. Use of this product before menarche is not indicated.

8.5 Geriatric Use

This product has not been studied in women over 65 years of age and is not indicated in this population.

8.6 Hepatic Impairment

No studies were conducted to evaluate the effect of hepatic disease on the disposition of NEXPLANON. The use of NEXPLANON in women with active liver disease is contraindicated [see *Contraindications (4)*].

8.7 Renal Impairment

No studies were conducted to evaluate the effect of renal disease on the disposition of NEXPLANON.

8.8 Overweight Women

The effectiveness of the etonogestrel implant in women who weighed more than 130% of their ideal body weight has not been defined because such women were not studied in clinical trials. Serum concentrations of etonogestrel are inversely related to body weight and decrease with time after implant insertion. It is therefore possible that NEXPLANON may be less effective in overweight women, especially in the presence of other factors that decrease serum etonogestrel concentrations such as concomitant use of hepatic enzyme inducers.

10 OVERDOSAGE

Overdosage may result if more than one implant is inserted. In case of suspected overdose, the implant should be removed.

11 DESCRIPTION

NEXPLANON is a radiopaque, progestin-only, soft, flexible implant preloaded in a sterile, disposable applicator for subdermal use. The implant is white/off-white, non-biodegradable and 4 cm in length with a diameter of 2 mm (see Figure 18). Each implant consists of an ethylene vinyl acetate (EVA) copolymer core, containing 68 mg of the synthetic progestin etonogestrel, barium sulfate (radiopaque ingredient), and may also contain magnesium stearate, surrounded by an EVA copolymer skin. Once inserted subdermally, the release rate is 60-70 mcg/day in week 5-6 and decreases to approximately 35-45 mcg/day at the end of the first year, to approximately 30-40 mcg/day at the end of the second year, and then to approximately 25-30 mcg/day at the end of the third year. NEXPLANON is a progestin-only contraceptive and does not contain estrogen. NEXPLANON does not contain latex.

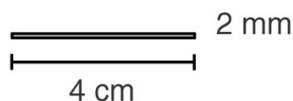

Figure 18 (Not to scale)

Etonogestrel [13-Ethyl-17-hydroxy-11-methylene-18,19-dinor-17 α -pregn-4-en-20-yn-3-one], structurally derived from 19-nortestosterone, is the synthetic biologically active metabolite of the synthetic progestin desogestrel. It has a molecular weight of 324.46 and the following structural formula (Figure 19).

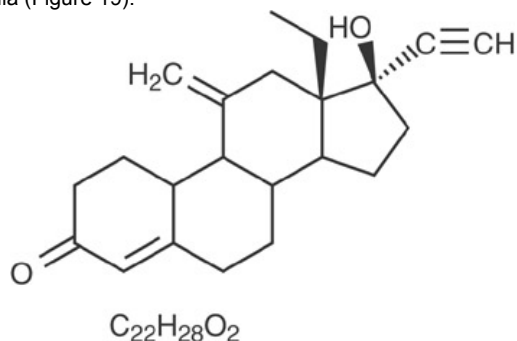

Figure 19

12 CLINICAL PHARMACOLOGY

12.1 Mechanism of Action

The contraceptive effect of NEXPLANON is achieved by suppression of ovulation, increased viscosity of the cervical mucus, and alterations in the endometrium.

12.2 Pharmacodynamics

Exposure-response relationships of NEXPLANON are unknown.

12.3 Pharmacokinetics

Absorption

After subdermal insertion of the etonogestrel implant, etonogestrel is released into the circulation and is approximately 100% bioavailable.

In a three year clinical trial, NEXPLANON and the non-radiopaque etonogestrel implant (IMPLANON) yielded comparable systemic exposure to etonogestrel. For NEXPLANON, the mean (\pm SD) maximum serum etonogestrel concentrations were 1200 (\pm 604) pg/mL and were reached within the first two weeks after insertion (n=50). The mean (\pm SD) serum etonogestrel concentration decreased gradually over time, declining to 202 (\pm 55) pg/mL at 12 months (n=41), 164 (\pm 58) pg/mL at 24 months (n=37), and 138 (\pm 43) pg/mL at 36 months (n=32). For the non-radiopaque etonogestrel implant (IMPLANON), the mean (\pm SD) maximum serum etonogestrel concentrations were 1145 (\pm 577) pg/mL and were reached within the first two weeks after insertion (n=53). The mean (\pm SD) serum etonogestrel concentration decreased gradually over time, declining to 223 (\pm 73) pg/mL at 12 months (n=40), 172 (\pm 77) pg/mL at 24 months (n=32), and 153 (\pm 52) pg/mL at 36 months (n=30).

The pharmacokinetic profile of NEXPLANON is shown in Figure 20.

Figure 20: Mean (\pm SD) Serum Concentration-Time Profile of Etonogestrel After Insertion of NEXPLANON During 3 Years of Use

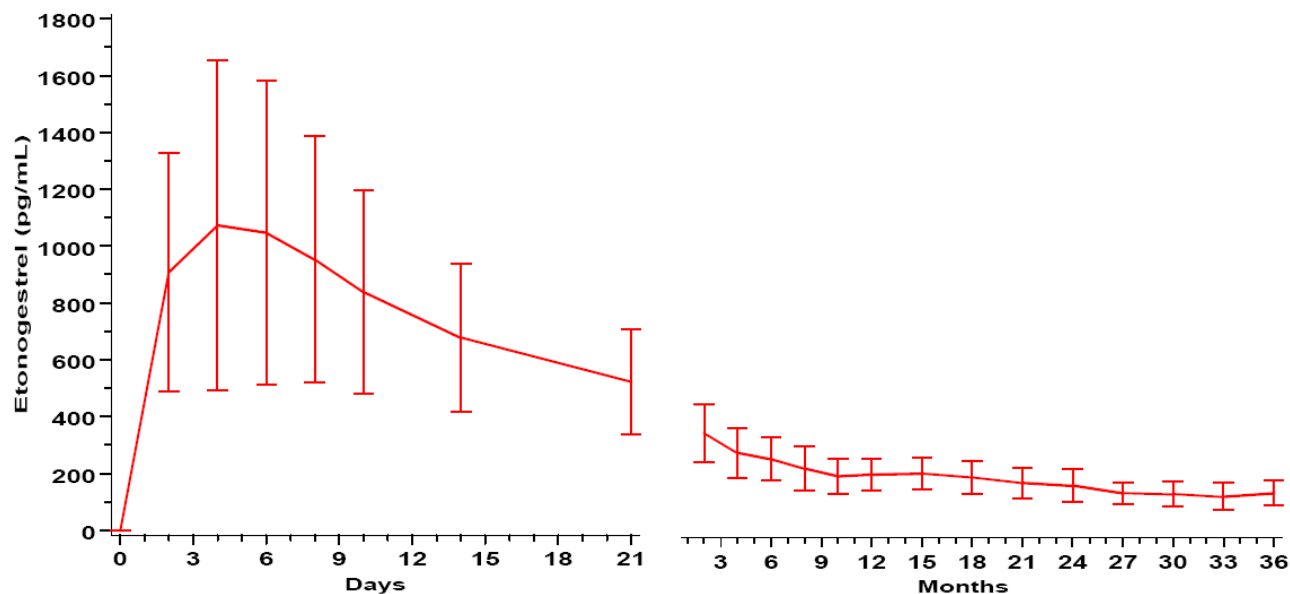

Distribution

The apparent volume of distribution averages about 201 L. Etonogestrel is approximately 32% bound to sex hormone binding globulin (SHBG) and 66% bound to albumin in blood.

Metabolism

In vitro data shows that etonogestrel is metabolized in liver microsomes by the cytochrome P450 3A4 isoenzyme. The biological activity of etonogestrel metabolites is unknown.

Excretion

The elimination half-life of etonogestrel is approximately 25 hours. Excretion of etonogestrel and its metabolites, either as free steroid or as conjugates, is mainly in urine and to a lesser extent in feces. After removal of the implant, etonogestrel concentrations decreased below sensitivity of the assay by one week.

13 NONCLINICAL TOXICOLOGY

13.1 Carcinogenesis, Mutagenesis, Impairment of Fertility

In a 24-month carcinogenicity study in rats with subdermal implants releasing 10 and 20 mcg etonogestrel per day (equal to approximately 1.8-3.6 times the systemic steady state exposure in women using NEXPLANON), no drug-related carcinogenic potential was observed. Etonogestrel was not genotoxic in the *in vitro* Ames/Salmonella reverse mutation assay, the chromosomal aberration assay in Chinese hamster ovary cells or in the *in vivo* mouse micronucleus test. Fertility in rats returned after withdrawal from treatment.

14 CLINICAL STUDIES

14.1 Pregnancy

In clinical trials of up to 3 years duration that involved 923 subjects, 18-40 years of age at entry, and 1756 women-years of use with the non-radiopaque etonogestrel implant (IMPLANON), the total exposures expressed as 28-day cycle equivalents by study year were:

- Year 1: 10,866 cycles
- Year 2: 8581 cycles
- Year 3: 3442 cycles

The clinical trials excluded women who:

- Weighed more than 130% of their ideal body weight
- Were chronically taking medications that induce liver enzymes

In the subgroup of women, 18-35 years of age at entry, 6 pregnancies during 20,648 cycles of use were reported. Two pregnancies occurred in each of Years 1, 2, and 3. Each conception was likely to have occurred shortly before or within 2 weeks after removal of the non-radiopaque etonogestrel implant. With these 6 pregnancies, the cumulative Pearl Index was 0.38 pregnancies per 100 women-years of use.

14.2 Return to Ovulation

In clinical trials with the non-radiopaque etonogestrel implant (IMPLANON), the etonogestrel levels in blood decreased below sensitivity of the assay by one week after removal of the implant. In addition, pregnancies were observed to occur as early as 7 to 14 days after removal. Therefore, a woman should re-start contraception immediately after removal of the implant if continued contraceptive protection is desired.

14.3 Implant Insertion and Removal Characteristics

Out of 301 insertions of the NEXPLANON implant in a clinical trial, the mean insertion time (from the removal of the protection cap of the applicator until retraction of the needle from the arm) was 27.9 ± 29.3 seconds. After insertion, 300 out of 301 (99.7%) NEXPLANON implants were palpable. The single, non-palpable implant was not inserted according to the instructions.

For 112 out of 114 (98.2%) subjects in 2 clinical trials for whom insertion and removal data were available, NEXPLANON implants were clearly visible with use of two-dimensional x-ray after insertion. The two implants that were not clearly visible after insertion were clearly visible with two-dimensional x-ray before removal.

16 HOW SUPPLIED/STORAGE AND HANDLING

16.1 How Supplied

NEXPLANON is supplied as follows:

NDC 0052-0274-01

One NEXPLANON package consists of a single implant containing 68 mg etonogestrel and 15 mg of barium sulfate that is 4 cm in length and 2 mm in diameter, which is pre-loaded in the needle of a disposable applicator. The sterile applicator containing the implant is packed in a blister pack.

NDC 0052-4330-01

One NEXPLANON package consists of a single implant containing 68 mg etonogestrel, 15 mg of barium sulfate and 0.1 mg of magnesium stearate that is 4 cm in length and 2 mm in diameter, which is pre-loaded in the needle of a disposable applicator. The sterile applicator containing the implant is packed in a blister pack.

16.2 Storage and Handling

Store NEXPLANON (etonogestrel implant) Radiopaque at 25°C (77°F); excursions permitted to 15-30°C (59-86°F) [see USP Controlled Room Temperature]. Avoid storing NEXPLANON at temperatures above 30°C (86°F).

17 PATIENT COUNSELING INFORMATION

See *FDA-Approved Patient Labeling*.

Information for Patients

- Counsel women about the insertion and removal procedure of the NEXPLANON implant. Provide the woman with a copy of the Patient Labeling and ensure that she understands the information in the Patient Labeling before insertion and removal. A USER CARD and consent form are included in the packaging. Have the woman complete a consent form and retain it in your records. The USER CARD should be filled out and given to the woman after insertion of the NEXPLANON implant so that she will have a record of the location of the implant in the upper arm and when it should be removed.
- Counsel women that NEXPLANON does not protect against HIV infection (AIDS) or other sexually transmitted diseases.
- Counsel women that the use of NEXPLANON may be associated with changes in their normal menstrual bleeding patterns so that they know what to expect.

FDA-Approved Patient Labeling

See the full patient product information for NEXPLANON.

Manufactured for: Merck Sharp & Dohme Corp., a subsidiary of
 **MERCK & CO., INC.**, Whitehouse Station, NJ 08889, USA

Manufactured by: N.V. Organon, Oss, The Netherlands, a subsidiary of **Merck & Co., Inc.**, Whitehouse Station, NJ 08889, USA

For patent information: www.merck.com/product/patent/home.html

Copyright © 2011 Merck Sharp & Dohme B.V., a subsidiary of **Merck & Co., Inc.**

All rights reserved.

Revised: 07/2014

FDA-Approved Patient Labeling

NEXPLANON® (etonogestrel implant) **Radiopaque** **Subdermal Use Only**

NEXPLANON® does not protect against HIV infection (the virus that causes AIDS) or other sexually transmitted diseases. Read this Patient Information leaflet carefully before you decide if NEXPLANON is right for you. This information does not take the place of talking with your healthcare provider. If you have any questions about NEXPLANON, ask your healthcare provider.

What is NEXPLANON?

NEXPLANON is a hormone-releasing birth control implant for use by women to prevent pregnancy for up to 3 years. The implant is a flexible plastic rod about the size of a matchstick that contains a progestin hormone called etonogestrel. It contains a small amount of barium sulfate so that the implant can be seen by X-ray, and may also contain magnesium stearate. Your healthcare provider will insert the implant just under the skin of the inner side of your upper arm. You can use a single NEXPLANON implant for up to 3 years. NEXPLANON does not contain estrogen.



What if I need birth control for more than 3 years?

The NEXPLANON implant must be removed after 3 years. Your healthcare provider can insert a new implant under your skin after taking out the old one if you choose to continue using NEXPLANON for birth control.

What if I change my mind about birth control and want to stop using NEXPLANON before 3 years?

Your healthcare provider can remove the implant at any time. You may become pregnant as early as the first week after removal of the implant. If you do not want to get pregnant after your healthcare provider removes the NEXPLANON implant, you should start another birth control method right away.

How does NEXPLANON work?

NEXPLANON prevents pregnancy in several ways. The most important way is by stopping the release of an egg from your ovary. NEXPLANON also thickens the mucus in your cervix and this change may keep sperm from reaching the egg. NEXPLANON also changes the lining of your uterus.

How well does NEXPLANON work?

When the NEXPLANON implant is placed correctly, your chance of getting pregnant is very low (less than 1 pregnancy per 100 women who use NEXPLANON for 1 year). It is not known if NEXPLANON is as effective in very overweight women because studies did not include many overweight women.

The following chart shows the chance of getting pregnant for women who use different methods of birth control. Each box on the chart contains a list of birth control methods that are similar in effectiveness. The most effective methods are at the top of the chart. The box on the bottom of the chart shows the chance of getting pregnant for women who do not use birth control and are trying to get pregnant.

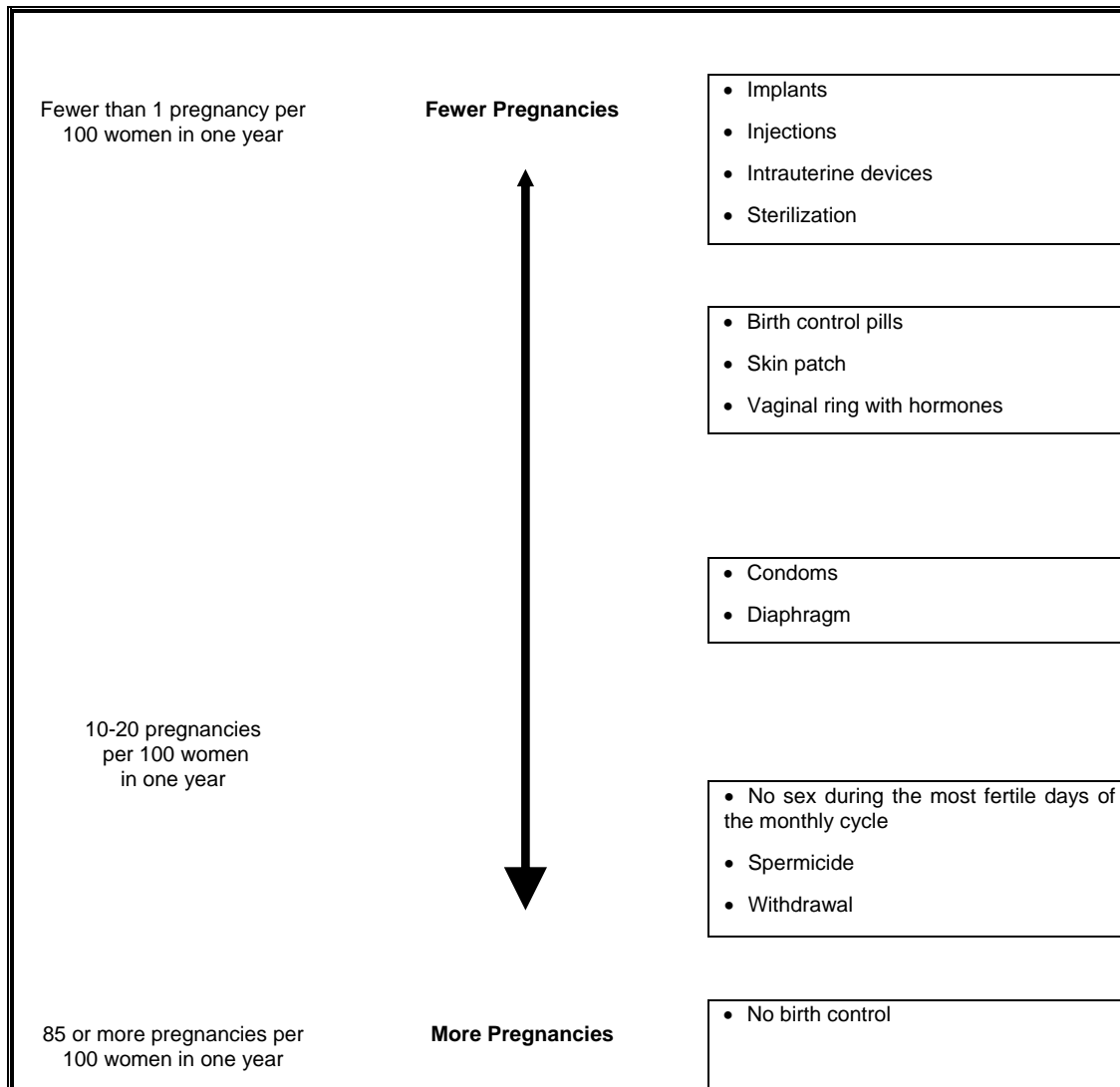

Who should not use NEXPLANON?

Do not use NEXPLANON if you:

- Are pregnant or think you may be pregnant
- Have, or have had blood clots, such as blood clots in your legs (deep venous thrombosis), lungs (pulmonary embolism), eyes (total or partial blindness), heart (heart attack), or brain (stroke)
- Have liver disease or a liver tumor
- Have unexplained vaginal bleeding
- Have breast cancer or any other cancer that is sensitive to progesterin (a female hormone), now or in the past
- Are allergic to anything in NEXPLANON

Tell your healthcare provider if you have or have had any of the conditions listed above. Your healthcare provider can suggest a different method of birth control.

In addition, talk to your healthcare provider about using NEXPLANON if you:

- Have diabetes
- Have high cholesterol or triglycerides
- Have headaches
- Have gallbladder or kidney problems
- Have a history of depressed mood
- Have high blood pressure
- Have an allergy to numbing medicines (anesthetics) or medicines used to clean your skin (antiseptics). These medicines will be used when the implant is placed into or removed from your arm.

Interaction with Other Medicines

Tell your healthcare provider about all the medicines you take, including prescription and non-prescription medicines, vitamins and herbal supplements. Certain medicines may make NEXPLANON less effective, including:

- barbiturates
- bosentan
- carbamazepine
- felbamate
- griseofulvin
- oxcarbazepine
- phenytoin
- rifampin
- St. John's wort
- topiramate
- HIV medicines

Ask your healthcare provider if you are not sure if your medicine is one listed above.

If there are medicines that you have been taking for a long time, that make NEXPLANON less effective, tell your healthcare provider. Your healthcare provider may remove the NEXPLANON implant and recommend a birth control method that can be used effectively with these medicines.

When you are using NEXPLANON, tell all of your healthcare providers that you have NEXPLANON in place in your arm.

How is the NEXPLANON implant placed and removed?

Your healthcare provider will place and remove the NEXPLANON implant in a minor surgical procedure in his or her office. The implant is placed just under the skin on the inner side of your upper arm.

The timing of insertion is important. Your healthcare provider may:

- Perform a pregnancy test before inserting NEXPLANON
- Schedule the insertion at a specific time of your menstrual cycle (for example, within the first days of your regular menstrual bleeding)

Immediately after the NEXPLANON implant has been placed, you and your healthcare provider should check that the implant is in your arm by feeling for it.

If you and your healthcare provider cannot feel the NEXPLANON implant, use a non-hormonal birth control method (such as condoms) until your healthcare provider confirms that the implant is in place. You may need special tests to check that the implant is in place or to help find the implant when it is time to take it out.

Your healthcare provider will cover the site where NEXPLANON was placed with 2 bandages. Leave the top bandage on for 24 hours. Keep the smaller bandage clean, dry, and in place for 3 to 5 days.

You will be asked to review and sign a consent form prior to inserting the NEXPLANON implant. You will also get a USER CARD to keep at home with your health records. Your healthcare provider will fill out the USER CARD with the date the implant was inserted and the date the implant is to be removed. Keep track of the date the implant is to be removed. Schedule an appointment with your healthcare provider to remove the implant on or before the removal date.

Be sure to have checkups as advised by your healthcare provider.

What are the most common side effects I can expect while using NEXPLANON?

• Changes in Menstrual Bleeding Patterns (menstrual periods)

The most common side effect of NEXPLANON is a change in your normal menstrual bleeding pattern. In studies, one out of ten women stopped using the implant because of an unfavorable change in their bleeding pattern. You may experience longer or shorter bleeding during your periods or have no bleeding at all. The time between periods may vary, and in between periods you may also have spotting.

Tell your healthcare provider right away if:

- You think you may be pregnant
- Your menstrual bleeding is heavy and prolonged

Besides changes in menstrual bleeding patterns, other frequent side effects that caused women to stop using the implant include:

- Mood swings
- Weight gain
- Headache

- Acne
- Depressed mood

Other common side effects include:

- Headache
- Vaginitis (inflammation of the vagina)
- Weight gain
- Acne
- Breast pain
- Viral infections such as sore throats or flu-like symptoms
- Stomach pain
- Painful periods
- Mood swings, nervousness, or depressed mood
- Back pain
- Nausea
- Dizziness
- Pain
- Pain at the site of insertion

This is not a complete list of possible side effects. For more information, ask your healthcare provider for advice about any side effects that concern you. You may report side effects to the FDA at 1-800-FDA-1088.

What are the possible risks of using NEXPLANON?

- **Problems with Insertion and Removal**

The implant may not be placed in your arm at all due to a failed insertion. If this happens, you may become pregnant. Immediately after insertion, and with help from your healthcare provider, you should be able to feel the implant under your skin. If you can't feel the implant, tell your healthcare provider.

Removal of the implant may be very difficult or impossible because the implant is not where it should be. Special procedures, including surgery in the hospital, may be needed to remove the implant. If the implant is not removed, then the effects of NEXPLANON will continue for a longer period of time.

Other problems related to insertion and removal are:

- Pain, irritation, swelling, or bruising at the insertion site
- Scarring, including a thick scar called a keloid around the insertion site
- Infection
- Scar tissue may form around the implant making it difficult to remove
- The implant may come out by itself. You may become pregnant if the implant comes out by itself. Use a back up birth control method and call your healthcare provider right away if the implant comes out.
- The need for surgery in the hospital to remove the implant
- Injury to nerves or blood vessels in your arm
- The implant breaks making removal difficult

- **Ectopic Pregnancy**

If you become pregnant while using NEXPLANON, you have a slightly higher chance that the pregnancy will be ectopic (occurring outside the womb) than do women who do not use birth control. Unusual vaginal bleeding or lower stomach (abdominal) pain may be a sign of ectopic pregnancy. Ectopic pregnancy is a medical emergency that often requires surgery. Ectopic pregnancies can cause serious internal bleeding, infertility, and even death. Call your healthcare provider right away if you think you are pregnant or have unexplained lower stomach (abdominal) pain.

- **Ovarian Cysts**

Cysts may develop on the ovaries and usually go away without treatment but sometimes surgery is needed to remove them.

- **Breast Cancer**

It is not known whether NEXPLANON use changes a woman's risk for breast cancer. If you have breast cancer now, or have had it in the past, do not use NEXPLANON because some breast cancers are sensitive to hormones.

- **Serious Blood Clots**

NEXPLANON may increase your chance of serious blood clots, especially if you have other risk factors such as smoking. It is possible to die from a problem caused by a blood clot, such as a heart attack or a stroke.

Some examples of serious blood clots are blood clots in the:

- Legs (deep vein thrombosis)
- Lungs (pulmonary embolism)
- Brain (stroke)

- Heart (heart attack)
- Eyes (total or partial blindness)

The risk of serious blood clots is increased in women who smoke. If you smoke and want to use NEXPLANON, you should quit. Your healthcare provider may be able to help.

Tell your healthcare provider at least 4 weeks before if you are going to have surgery or will need to be on bed rest. You have an increased chance of getting blood clots during surgery or bed rest.

- **Other Risks**

A few women who use birth control that contains hormones may get:

- High blood pressure
- Gallbladder problems
- Rare cancerous or noncancerous liver tumors

When should I call my healthcare provider?

Call your healthcare provider right away if you have:

- Pain in your lower leg that does not go away
- Severe chest pain or heaviness in the chest
- Sudden shortness of breath, sharp chest pain, or coughing blood
- Symptoms of a severe allergic reaction, such as swollen face, tongue or throat; trouble breathing or swallowing
- Sudden severe headache unlike your usual headaches
- Weakness or numbness in your arm, leg, or trouble speaking
- Sudden partial or complete blindness
- Yellowing of your skin or whites of your eyes, especially with fever, tiredness, loss of appetite, dark colored urine, or light colored bowel movements
- Severe pain, swelling, or tenderness in the lower stomach (abdomen)
- Lump in your breast
- Problems sleeping, lack of energy, tiredness, or you feel very sad
- Heavy menstrual bleeding

What if I become pregnant while using NEXPLANON?

You should see your healthcare provider right away if you think that you may be pregnant. It is important to remove the implant and make sure that the pregnancy is not ectopic (occurring outside the womb). Based on experience with other hormonal contraceptives, NEXPLANON is not likely to cause birth defects.

Can I use NEXPLANON when I am breastfeeding?

If you are breastfeeding your child, you may use NEXPLANON if 4 weeks have passed since you had your baby. A small amount of the hormone contained in NEXPLANON passes into your breast milk. The health of breast-fed children whose mothers were using the implant has been studied up to 3 years of age in a small number of children. No effects on the growth and development of the children were seen. If you are breastfeeding and want to use NEXPLANON, talk with your healthcare provider for more information.

Additional Information

This Patient Information leaflet contains important information about NEXPLANON. If you would like more information, talk with your healthcare provider. You can ask your healthcare provider for information about NEXPLANON that is written for healthcare professionals. You may also call 1-877-467-5266 or visit www.NEXPLANON-USA.com.

Manufactured for: Merck Sharp & Dohme Corp., a subsidiary of
 **MERCK & CO., INC.**, Whitehouse Station, NJ 08889, USA

Manufactured by: N.V. Organon, Oss, The Netherlands, a subsidiary of **Merck & Co., Inc.**, Whitehouse Station, NJ 08889, USA

For patent information: www.merck.com/product/patent/home.html

Copyright © 2011 Merck Sharp & Dohme B.V., a subsidiary of **Merck & Co., Inc.**

All rights reserved.

Revised: 07/2014