

## HIGHLIGHTS OF PRESCRIBING INFORMATION

These highlights do not include all the information needed to use ARIKAYCE safely and effectively. See full prescribing information for ARIKAYCE.

ARIKAYCE® (amikacin liposome inhalation suspension), for oral inhalation use

Initial U.S. Approval: 2018

LIMITED POPULATION

### WARNING: RISK OF INCREASED RESPIRATORY ADVERSE REACTIONS

See full prescribing information for complete boxed warning.

ARIKAYCE has been associated with a risk of increased respiratory adverse reactions, including, hypersensitivity pneumonitis, hemoptysis, bronchospasm, and exacerbation of underlying pulmonary disease that have led to hospitalizations in some cases. (5.1, 5.2, 5.3, 5.4)

## INDICATIONS AND USAGE

LIMITED POPULATION: ARIKAYCE is an aminoglycoside antibacterial indicated in adults who have limited or no alternative treatment options, for the treatment of *Mycobacterium avium* complex (MAC) lung disease as part of a combination antibacterial drug regimen in patients who do not achieve negative sputum cultures after a minimum of 6 consecutive months of a multidrug background regimen therapy. As only limited clinical safety and effectiveness data for ARIKAYCE are currently available, reserve ARIKAYCE for use in adults who have limited or no alternative treatment options. This drug is indicated for use in a limited and specific population of patients. (1)

This indication is approved under accelerated approval based on achieving sputum culture conversion (defined as 3 consecutive negative monthly sputum cultures) by Month 6. Clinical benefit has not yet been established. (1)

### Limitation of Use:

ARIKAYCE has only been studied in patients with refractory MAC lung disease defined as patients who did not achieve negative sputum cultures after a minimum of 6 consecutive months of a multidrug background regimen therapy. The use of ARIKAYCE is not recommended for patients with non-refractory MAC lung disease.

## DOSAGE AND ADMINISTRATION

- For oral inhalation use only. (2.1)
- Use ARIKAYCE vials only with the Lamira Nebulizer System. (2.1)
- Pre-treatment with inhaled bronchodilator should be considered in patients with a history of hyperreactive airway disease. (2.1)
- The recommended dosage in adults is once daily oral inhalation of the contents of one 590 mg/8.4 mL ARIKAYCE vial. (2.2)

## DOSAGE FORMS AND STRENGTHS

ARIKAYCE is supplied as a sterile, aqueous, liposome suspension for oral inhalation in a unit-dose glass vial containing amikacin 590 mg/8.4 mL. (3)

## CONTRAINDICATIONS

ARIKAYCE is contraindicated in patients with a known hypersensitivity to any aminoglycoside. (4)

## WARNINGS AND PRECAUTIONS

- **Hypersensitivity Pneumonitis:** Reported with ARIKAYCE treatment; if hypersensitivity pneumonitis occurs, discontinue ARIKAYCE and manage patients as medically appropriate. (5.1)
- **Hemoptysis:** Higher frequency of hemoptysis has been reported with ARIKAYCE treatment. If hemoptysis occurs, manage the patients as medically appropriate. (5.2)
- **Bronchospasm:** Higher frequency of bronchospasm has been reported with ARIKAYCE treatment. Treat patients as medically appropriate if this occurs during treatment with ARIKAYCE. (5.3)
- **Exacerbations of Underlying Pulmonary Disease:** Higher frequency of exacerbations of underlying pulmonary disease has been reported with ARIKAYCE treatment. Treat patients as medically appropriate if this occurs during treatment with ARIKAYCE. (5.4)
- **Anaphylaxis and Hypersensitivity Reactions:** Serious and potentially life-threatening hypersensitivity reactions, including anaphylaxis, have been reported in patients taking ARIKAYCE. If anaphylaxis or a hypersensitivity reaction occurs, discontinue ARIKAYCE and institute appropriate supportive measures. (5.5)
- **Ototoxicity:** Higher frequency of ototoxicity has been reported with ARIKAYCE treatment. Closely monitor patients with known or suspected auditory or vestibular dysfunction. If patients develop tinnitus this may be an early symptom of ototoxicity. (5.6)
- **Nephrotoxicity:** Nephrotoxicity was observed during the clinical trials of ARIKAYCE in patients with MAC lung disease but not at a higher frequency than the background regimen alone. Aminoglycosides have been associated with nephrotoxicity. Close monitoring of patients with known or suspected renal dysfunction may be needed when prescribing ARIKAYCE. (5.7)
- **Neuromuscular Blockade:** Aminoglycosides may aggravate muscle weakness by blocking the release of acetylcholine at neuromuscular junctions. Closely monitor patients with known or suspected neuromuscular disorders, such as myasthenia gravis. If neuromuscular blockade occurs, it may be reversed by the administration of calcium salts but mechanical respiratory assistance may be necessary. (5.8)
- **Embryo-Fetal Toxicity:** Aminoglycosides can cause fetal harm when administered to a pregnant woman. Aminoglycosides, including ARIKAYCE, may be associated with total, irreversible, bilateral congenital deafness in pediatric patients exposed *in utero*. Advise pregnant women of the potential risk to a fetus. (5.9, 8.1)

## ADVERSE REACTIONS

Most common adverse reactions (incidence  $\geq 10\%$  and higher than control) in the patients with refractory MAC lung disease were: dysphonia, cough, bronchospasm, hemoptysis, musculoskeletal pain, upper airway irritation, ototoxicity, fatigue/asthenia, exacerbation of underlying pulmonary disease, diarrhea, nausea, and headache. (6.1)

To report SUSPECTED ADVERSE REACTIONS, contact Inmed Incorporated at 1-844-4-INSMED or FDA at 1-800-FDA-1088 or [www.fda.gov/medwatch](http://www.fda.gov/medwatch).

See 17 for PATIENT COUNSELING INFORMATION and Medication Guide.

Revised: 10/2020

---

**FULL PRESCRIBING INFORMATION: CONTENTS\***

**WARNING: RISK OF INCREASED RESPIRATORY ADVERSE REACTIONS**

**1 INDICATIONS AND USAGE**

**2 DOSAGE AND ADMINISTRATION**

- 2.1 Important Administration Instructions
- 2.2 Recommended Dosage

**3 DOSAGE FORMS AND STRENGTHS**

**4 CONTRAINDICATIONS**

**5 WARNINGS AND PRECAUTIONS**

- 5.1 Hypersensitivity Pneumonitis
- 5.2 Hemoptysis
- 5.3 Bronchospasm
- 5.4 Exacerbation of Underlying Pulmonary Disease
- 5.5 Anaphylaxis and Hypersensitivity Reactions
- 5.6 Ototoxicity
- 5.7 Nephrotoxicity
- 5.8 Neuromuscular Blockade
- 5.9 Embryo-Fetal Toxicity

**6 ADVERSE REACTIONS**

- 6.1 Clinical Trials Experience
- 6.2 Postmarketing Experience

**7 DRUG INTERACTIONS**

- 7.1 Drugs with Neurotoxic, Nephrotoxic, or Ototoxic Potential
- 7.2 Ethacrynic Acid, Furosemide, Urea, or Mannitol

**8 USE IN SPECIFIC POPULATIONS**

- 8.1 Pregnancy
- 8.2 Lactation
- 8.4 Pediatric Use
- 8.5 Geriatric Use
- 8.6 Hepatic Impairment
- 8.7 Renal Impairment

**10 OVERDOSAGE**

**11 DESCRIPTION**

**12 CLINICAL PHARMACOLOGY**

- 12.1 Mechanism of Action
- 12.2 Pharmacodynamics
- 12.3 Pharmacokinetics
- 12.4 Microbiology

**13 NONCLINICAL TOXICOLOGY**

- 13.1 Carcinogenesis, Mutagenesis, Impairment of Fertility
- 13.2 Animal Toxicology and/or Pharmacology

**14 CLINICAL STUDIES**

**16 HOW SUPPLIED/STORAGE AND HANDLING**

- 16.1 How Supplied
- 16.2 Storage and Handling

**17 PATIENT COUNSELING INFORMATION**

\* Sections or subsections omitted from the full prescribing information are not listed.

---

## FULL PRESCRIBING INFORMATION

### **WARNING: RISK OF INCREASED RESPIRATORY ADVERSE REACTIONS**

**ARIKAYCE has been associated with an increased risk of respiratory adverse reactions including, hypersensitivity pneumonitis, hemoptysis, bronchospasm, exacerbation of underlying pulmonary disease that have led to hospitalizations in some cases [see *Warnings and Precautions* (5.1, 5.2, 5.3, 5.4)].**

## 1 INDICATIONS AND USAGE

**LIMITED POPULATION:** ARIKAYCE® is indicated in adults, who have limited or no alternative treatment options, for the treatment of *Mycobacterium avium* complex (MAC) lung disease as part of a combination antibacterial drug regimen in patients who do not achieve negative sputum cultures after a minimum of 6 consecutive months of a multidrug background regimen therapy. As only limited clinical safety and effectiveness data for ARIKAYCE are currently available, reserve ARIKAYCE for use in adults who have limited or no alternative treatment options. This drug is indicated for use in a limited and specific population of patients.

This indication is approved under accelerated approval based on achieving sputum culture conversion (defined as 3 consecutive negative monthly sputum cultures) by Month 6. Clinical benefit has not yet been established [see *Clinical Studies* (14)]. Continued approval for this indication may be contingent upon verification and description of clinical benefit in confirmatory trials.

### Limitation of Use:

ARIKAYCE has only been studied in patients with refractory MAC lung disease defined as patients who did not achieve negative sputum cultures after a minimum of 6 consecutive months of a multidrug background regimen therapy. The use of ARIKAYCE is not recommended for patients with non-refractory MAC lung disease.

## 2 DOSAGE AND ADMINISTRATION

### 2.1 Important Administration Instructions

ARIKAYCE is for oral inhalation use only. Administer by nebulization only with the Lamira® Nebulizer System. Refer to the Instructions for Use for full administration information on use of ARIKAYCE with the Lamira Nebulizer System.

Instruct patients using a bronchodilator (‘reliever’) to first use the bronchodilator following the bronchodilator leaflet for use information before using ARIKAYCE.

Pre-treatment with short-acting selective beta-2 agonists should be considered for patients with known hyperreactive airway disease, chronic obstructive pulmonary disease, asthma, or bronchospasm [see *Warnings and Precautions* (5.3)].

### 2.2 Recommended Dosage

The recommended dosage of ARIKAYCE in adults is once daily inhalation of the contents of one 590 mg/8.4 mL ARIKAYCE vial (590 mg of amikacin) using the Lamira Nebulizer System [see *Clinical Studies* (14)].

Administer ARIKAYCE with the Lamira Nebulizer System only. ARIKAYCE should be at room temperature before use. Prior to opening, shake the ARIKAYCE vial well for at least 10 to 15 seconds until the contents appear uniform and well mixed. The ARIKAYCE vial is opened by flipping up the plastic top of the vial then pulling downward to loosen the metal ring. The metal ring and the rubber stopper should be removed carefully. The contents of the ARIKAYCE vial can then be poured into the medication reservoir of the nebulizer handset.

If a daily dose of ARIKAYCE is missed, administer the next dose the next day. Do **NOT** double the dose to make up for the missed dose.

### 3 DOSAGE FORMS AND STRENGTHS

ARIKAYCE is supplied as a sterile, white, milky, aqueous, liposome suspension for oral inhalation in a unit-dose glass vial containing amikacin 590 mg/8.4 mL (equivalent to amikacin sulfate 623 mg/8.4 mL).

### 4 CONTRAINDICATIONS

ARIKAYCE is contraindicated in patients with a known hypersensitivity to any aminoglycoside.

### 5 WARNINGS AND PRECAUTIONS

#### 5.1 Hypersensitivity Pneumonitis

Hypersensitivity pneumonitis has been reported with the use of ARIKAYCE in the clinical trials. Hypersensitivity pneumonitis (reported as allergic alveolitis, pneumonitis, interstitial lung disease, allergic reaction to ARIKAYCE) was reported at a higher frequency in patients treated with ARIKAYCE plus a background regimen (3.1%) compared to patients treated with a background regimen alone (0%). Most patients with hypersensitivity pneumonitis discontinued treatment with ARIKAYCE and received treatment with corticosteroids [see *Adverse Reactions (6.1)*]. If hypersensitivity pneumonitis occurs, discontinue ARIKAYCE and manage the patient as medically appropriate.

#### 5.2 Hemoptysis

Hemoptysis has been reported with the use of ARIKAYCE in the clinical trials. Hemoptysis was reported at a higher frequency in patients treated with ARIKAYCE plus a background regimen (18.4%) compared to patients treated with a background regimen alone (13.4%) [see *Adverse Reactions (6.1)*]. If hemoptysis occurs, manage the patients as medically appropriate.

#### 5.3 Bronchospasm

Bronchospasm has been reported with the use of ARIKAYCE in the clinical trials. Bronchospasm (reported as asthma, bronchial hyperreactivity, bronchospasm, dyspnea, dyspnea exertional, prolonged expiration, throat tightness, wheezing) was reported at a higher frequency in patients treated with ARIKAYCE plus a background regimen (28.7%) compared to patients treated with a background regimen alone (10.7%) [see *Adverse Reactions (6.1)*]. If bronchospasm occurs during the use of ARIKAYCE, treat the patients as medically appropriate.

#### 5.4 Exacerbation of Underlying Pulmonary Disease

Exacerbations of underlying pulmonary disease have been reported with the use of ARIKAYCE in the clinical trials. Exacerbations of underlying pulmonary disease (reported as chronic obstructive pulmonary disease, infective exacerbation of chronic obstructive pulmonary disease, infective exacerbation of bronchiectasis) have been reported at a higher frequency in patients treated with ARIKAYCE plus a background regimen (15.2%) compared to patients treated with background regimen alone (9.8%) [see *Adverse Reactions (6.1)*]. If exacerbations of underlying pulmonary disease occur during the use of ARIKAYCE, treat the patients as medically appropriate.

#### 5.5 Anaphylaxis and Hypersensitivity Reactions

Serious and potentially life-threatening hypersensitivity reactions, including anaphylaxis, have been reported in patients taking ARIKAYCE. Signs and symptoms include acute onset of skin and mucosal tissue hypersensitivity reactions (hives, itching, flushing, swollen lips/tongue/uvula), respiratory difficulty (shortness of breath, wheezing, stridor, cough), gastrointestinal symptoms (nausea, vomiting, diarrhea, crampy abdominal pain), and cardiovascular signs and symptoms of anaphylaxis (tachycardia, low blood pressure, syncope, incontinence, dizziness). Before therapy with ARIKAYCE is instituted, evaluate for previous hypersensitivity reactions to aminoglycosides. If anaphylaxis or a hypersensitivity reaction occurs, discontinue ARIKAYCE and institute appropriate supportive measures.

#### 5.6 Ototoxicity

Ototoxicity has been reported with the use of ARIKAYCE in the clinical trials. Ototoxicity (including deafness, dizziness, presyncope, tinnitus, and vertigo) were reported with a higher frequency in patients treated with ARIKAYCE plus a background regimen (17%) compared to patients treated with background regimen alone (9.8%). This was primarily driven by tinnitus (8.1% in ARIKAYCE plus background regimen vs. 0.9% in the background regimen alone arm) and dizziness (6.3% in ARIKAYCE plus background regimen vs. 2.7% in the background regimen alone arm). [see *Adverse Reactions (6.1)*].

Closely monitor patients with known or suspected auditory or vestibular dysfunction during treatment with ARIKAYCE. If ototoxicity occurs, manage the patient as medically appropriate, including potentially discontinuing ARIKAYCE.

### 5.7 Nephrotoxicity

Nephrotoxicity was observed during the clinical trials of ARIKAYCE in patients with MAC lung disease but not at a higher frequency than the background regimen alone [see *Adverse Reactions (6.1)*]. Nephrotoxicity has been associated with the aminoglycosides. Close monitoring of patients with known or suspected renal dysfunction may be needed when prescribing ARIKAYCE.

### 5.8 Neuromuscular Blockade

Patients with neuromuscular disorders were not enrolled in ARIKAYCE clinical trials. Aminoglycosides may aggravate muscle weakness by blocking the release of acetylcholine at neuromuscular junctions. Closely monitor patients with known or suspected neuromuscular disorders, such as myasthenia gravis. If neuromuscular blockade occurs, it may be reversed by the administration of calcium salts but mechanical respiratory assistance may be necessary.

### 5.9 Embryo-Fetal Toxicity

Aminoglycosides can cause fetal harm when administered to a pregnant woman. Aminoglycosides, including ARIKAYCE, may be associated with total, irreversible, bilateral congenital deafness in pediatric patients exposed *in utero*. Patients who use ARIKAYCE during pregnancy, or become pregnant while taking ARIKAYCE should be apprised of the potential hazard to the fetus [see *Use in Specific Populations (8.1)*].

## 6 ADVERSE REACTIONS

The following clinically significant adverse reactions are described in greater detail in other sections of labeling:

- Hypersensitivity pneumonitis [see *Boxed Warning and Warnings and Precautions (5.1)*]
- Hemoptysis [see *Boxed Warning and Warnings and Precautions (5.2)*]
- Bronchospasm [see *Boxed Warning and Warnings and Precautions (5.3)*]
- Exacerbation of Underlying Pulmonary Disease [see *Boxed Warning and Warnings and Precautions (5.4)*]
- Anaphylaxis and Hypersensitivity Reactions [see *Warnings and Precautions (5.5)*]
- Ototoxicity [see *Warnings and Precautions (5.6)*]
- Nephrotoxicity [see *Warnings and Precautions (5.7)*]
- Neuromuscular Blockade [see *Warnings and Precautions (5.8)*]

### 6.1 Clinical Trials Experience

Because clinical trials are conducted under widely varying conditions, adverse reaction rates observed in the clinical trials of a drug cannot be directly compared to rates in the clinical trials of another drug and may not reflect the rates observed in practice.

#### Overview of Clinical Trials for Safety Evaluation

Within the refractory NTM clinical program, 404 patients that participated in three clinical trials were treated with ARIKAYCE at the dose of 590 mg/day (median duration of exposure to ARIKAYCE was 236.5 days).

Trial 1 (NCT#02344004) was an open-label, randomized (2:1), multi-center Phase 3 trial in patients with refractory *Mycobacterium avium* complex (MAC) lung disease. Patients were randomized to either 8 months of ARIKAYCE plus a background regimen (n=223) or background regimen alone (n=112).

Trial 2 (NCT#02628600) was a single-arm extension of Trial 1 for refractory MAC lung disease patients that failed to achieve negative sputum cultures after 6 months of treatment or had a relapse or recurrence by Month 6 from either study arm of Trial 1. A total of 163 patients (n=90 from the prior background regimen alone arm of Trial 1, and n=73 from the prior ARIKAYCE plus background regimen arm in Trial 1) participated in the trial.

Trial 3 (NCT#01315236) was a double-blind, randomized, placebo-controlled Phase 2 study in patients with refractory nontuberculous mycobacterial (NTM) lung disease caused by MAC and *Mycobacterium*

*abscessus*. Patients were randomized to either ARIKAYCE plus background regimen (N=44) or an inhaled diluted empty liposome placebo plus background regimen (N=45) for 84 days.

Across all clinical trials of patients with and without refractory NTM lung infection, 818 patients were exposed to multiple doses of ARIKAYCE.

#### Adverse Reactions Leading to Treatment Discontinuation

In the three NTM studies, there was a higher incidence of premature discontinuation of ARIKAYCE. In Trial 1, 34.5% discontinued ARIKAYCE prematurely; most were due to adverse reactions (18.8%) and withdrawal by subject (9.9%). In the comparator arm, 10.7% of subjects discontinued their background regimen, with 0.9% due to adverse reactions and 5.4% due to withdrawal by subject. In Trial 2 (the single-arm extension of Trial 1), 37.8% of patients starting on ARIKAYCE discontinued prematurely with 24.4% discontinuing due to adverse reactions. In Trial 3, all 9 (20.5%) premature discontinuations occurred in the ARIKAYCE plus background regimen-treated patients and there were no premature discontinuations in the placebo plus background regimen arm.

#### Serious Adverse Reactions in Trials 1 and 3

In Trial 1, 19.7% of patients treated with ARIKAYCE plus background regimen reported SAR as compared to 16.1% of patients treated with background regimen alone. In addition, in Trial 1 [2 to 1 randomization, ARIKAYCE plus background regimen versus background regimen alone], there were 80 hospitalizations in 41 patients (18.4%) treated with ARIKAYCE plus background regimen compared to 29 hospitalizations in 15 patients (13.4%) treated with background regimen alone. The most common SARs and reasons for hospitalization in the ARIKAYCE plus background regimen arm were related to exacerbation of underlying pulmonary disease and lower respiratory tract infections, such as pneumonia.

In Trial 3, 18.2% of patients treated with ARIKAYCE plus background regimen reported SARs compared to 8.9% of patients treated with background regimen plus inhaled placebo.

#### Common Adverse Reactions

The incidence of adverse reactions in Trial 1 are displayed in Table 1. Only those adverse reactions with a rate of at least 5% in the ARIKAYCE plus background regimen group and greater than the background regimen alone group, are shown.

<b>Adverse Reaction</b>	<b>ARIKAYCE plus Background Regimen (N=223) n (%)</b>	<b>Background Regimen Alone (N=112) n (%)</b>
Dysphonia <sup>a</sup>	106 (48)	2 (2)
Cough <sup>b</sup>	88 (40)	19 (17)
Bronchospasm <sup>c</sup>	64 (29)	12 (11)
Hemoptysis	41 (18)	15 (13)
Musculoskeletal pain <sup>d</sup>	40 (18)	10 (9)
Upper airway irritation <sup>c</sup>	39 (18)	2 (2)
Ototoxicity <sup>f</sup>	38 (17)	11 (10)
Fatigue and asthenia	36 (16)	11 (10)
Exacerbation of underlying pulmonary disease <sup>g</sup>	34 (15)	11 (10)
Diarrhea	28 (13)	5 (5)
Nausea	26 (12)	4 (4)
Headache	22 (10)	5 (5)
Pneumonia <sup>h</sup>	20 (9)	10 (9)
Pyrexia	17 (8)	5 (5)
Weight decreased	16 (7)	1 (1)
Vomiting <sup>i</sup>	15 (7)	4 (4)
Rash <sup>i</sup>	14 (6)	1 (1)
Change in sputum <sup>k</sup>	13 (6)	1 (1)
Chest discomfort	12 (5)	3 (3)

<sup>a</sup>Includes aphonia and dysphonia

<sup>b</sup>Includes cough, productive cough, and upper airway cough syndrome

<sup>c</sup>Includes asthma, bronchial hyperreactivity, bronchospasm, dyspnea, dyspnea exertional, prolonged expiration, throat tightness, and wheezing

<sup>d</sup>Includes back pain, arthralgia, myalgia, pain/body aches, muscle spasm and musculoskeletal pain

<sup>e</sup>Includes oropharyngeal pain, oropharyngeal discomfort, throat irritation, pharyngeal erythema, upper airway inflammation, pharyngeal edema, vocal cord inflammation, laryngeal pain, laryngeal erythema, laryngitis

<sup>f</sup>Includes deafness, deafness neurosensory, deafness unilateral, dizziness, hypoacusis, presyncope, tinnitus, vertigo, balance disorders

<sup>g</sup>Includes COPD, infective exacerbation of COPD, infective exacerbation of bronchiectasis

<sup>h</sup>Includes atypical pneumonia, empyema, infection pleural effusion, lower respiratory tract infection, lung infection, lung infection pseudomonas, pneumonia, pneumonia aspiration, pneumonia pseudomonas, pseudomonas infection, and respiratory tract infection

<sup>i</sup>Includes vomiting and post-tussive vomiting

<sup>j</sup>Includes rash, rash maculo-papular, drug eruption, and urticaria

<sup>k</sup>Includes increased sputum, sputum purulent, and sputum discolored

Selected adverse drug reactions that occurred in <5% of patients and at higher frequency in ARIKAYCE-treated patients in Trial 1 are presented in Table 2.

<b>Adverse Reaction</b>	<b>ARIKAYCE plus Background Regimen N=223 n (%)</b>	<b>Background Regimen Alone N=112 n (%)</b>
Anxiety <sup>a</sup>	10 (5)	0 (0)
Oral fungal infection <sup>b</sup>	9 (4)	2 (2)
Bronchitis	8 (4)	3 (3)
Dysgeusia	7 (3)	0 (0)
Hypersensitivity pneumonitis <sup>c</sup>	7 (3)	0 (0)
Dry mouth	6 (3)	0 (0)
Epistaxis	6 (3)	1 (1)
Respiratory failure <sup>d</sup>	6 (3)	2 (2)
Pneumothorax <sup>e</sup>	5 (2)	1 (1)
Exercise tolerance decreased	3 (1)	0 (0)
Balance disorder	3 (1)	0 (0)
Neuromuscular disorder <sup>f</sup>	2 (1)	0 (0)

<sup>a</sup>Includes anxiety and anxiety disorder

<sup>b</sup>Includes oral candidiasis and oral fungal infection

<sup>c</sup>Includes allergic alveolitis, interstitial lung disease, and pneumonitis

<sup>d</sup>Includes acute respiratory failure and respiratory failure

<sup>e</sup>Includes pneumothorax, pneumothorax spontaneous and pneumomediastinum

<sup>f</sup>Includes muscle weakness and neuropathy peripheral

Refer to Table 1 and Table 2 for the incidence rate of hypersensitivity pneumonitis, bronchospasm, cough, dysphonia, exacerbation of underlying disease, hemoptysis, ototoxicity, upper airway irritation, and neuromuscular disorders [see *Warnings and Precautions (5.1, 5.2, 5.3, 5.4, 5.6, 5.7)*]

## 6.2 Postmarketing Experience

The following adverse reactions have been identified from postmarketing surveillance. Because these adverse reactions are reported voluntarily from a population of unknown size, precise estimates of frequency cannot be made and a causal relationship to drug exposure cannot be established.

Immune System Disorders: hypersensitivity, anaphylaxis [see *Warnings and Precautions (5.5)*]

## 7 DRUG INTERACTIONS

### 7.1 Drugs with Neurotoxic, Nephrotoxic, or Ototoxic Potential

Avoid concomitant use of ARIKAYCE with medications associated with neurotoxicity, nephrotoxicity, and ototoxicity.

## 7.2 Ethacrynic Acid, Furosemide, Urea, or Mannitol

Some diuretics can enhance aminoglycoside toxicity by altering aminoglycoside concentrations in serum and tissue. Avoid concomitant use of ARIKAYCE with ethacrynic acid, furosemide, urea, or intravenous mannitol.

## 8 USE IN SPECIFIC POPULATIONS

### 8.1 Pregnancy

#### Risk Summary

There are no data on ARIKAYCE use in pregnant women to evaluate for any drug-associated risk of major birth defects, miscarriage or adverse maternal or fetal outcomes. Although systemic absorption of amikacin following oral inhalation is expected to be low [see *Clinical Pharmacology (12.3)*], systemic exposure to aminoglycoside antibacterial drugs, including ARIKAYCE, may be associated with total, irreversible, bilateral congenital deafness when administered to pregnant women [see *Warnings and Precautions (5.9)*]. Advise pregnant women of the potential risk to a fetus.

Animal reproductive toxicology studies have not been conducted with inhaled amikacin. Subcutaneous administration of amikacin to pregnant rats (up to 100 mg/kg/day) and mice (up to 400 mg/kg/day) during organogenesis was not associated with fetal malformations. Ototoxicity was not adequately evaluated in offspring in animal studies.

The estimated background risk of major birth defects and miscarriage for the indicated populations is unknown. All pregnancies have a background risk of birth defect, loss, or other adverse outcomes. In the U.S. general population, the estimated background risk of major birth defects and miscarriage in clinically recognized pregnancies is 2-4% and 15-20%, respectively.

#### Data

##### *Animal Data*

No animal reproductive toxicology studies have been conducted with ARIKAYCE or non-liposomal amikacin administered by inhalation.

Amikacin was subcutaneously administered to pregnant rats (Gestation Days 8-14) and mice (Gestation Days 7-13) at doses of 25, 100, or 400 mg/kg to assess developmental toxicity. These doses did not cause fetal visceral or skeletal malformations in mice. The high dose was excessively maternally toxic in rats (nephrotoxicity and mortality were observed), precluding the evaluation of offspring at this dose. Fetal malformations were not observed at the low or mid dose in rats. Postnatal development of the rats and mice exposed to these doses of amikacin *in utero* did not differ significantly from control.

Ototoxicity was not adequately evaluated in offspring in animal developmental toxicology studies.

### 8.2 Lactation

#### Risk Summary

There is no information regarding the presence of ARIKAYCE in human milk, the effects on the breastfed infant, or the effects on milk production after administration of ARIKAYCE by inhalation. Although limited published data on other routes of administration of amikacin indicate that amikacin is present in human milk, systemic absorption of ARIKAYCE following inhaled administration is expected to be low [see *Clinical Pharmacology (12.3)*]. The developmental and health benefits of breastfeeding should be considered along with the mother's clinical need for ARIKAYCE and any potential adverse effects on the breastfed child from ARIKAYCE or from the underlying maternal condition.

### 8.4 Pediatric Use

Safety and effectiveness of ARIKAYCE in pediatric patients below 18 years of age have not been established.

### 8.5 Geriatric Use

In the NTM clinical trials, of the total number of patients receiving ARIKAYCE, 208 (51.5%) were  $\geq$  65 years and 59 (14.6%) were  $\geq$  75 years. No overall differences in safety and effectiveness were observed between elderly subjects and younger subjects. Because elderly patients are more likely to have decreased renal function, it may be useful to monitor renal function [see *Warnings and Precautions (5.7)*].



## 8.6 Hepatic Impairment

ARIKAYCE has not been studied in patients with hepatic impairment. No dose adjustments based on hepatic impairment are required since amikacin is not hepatically metabolized [see *Clinical Pharmacology (12.3)*].

## 8.7 Renal Impairment

ARIKAYCE has not been studied in patients with renal impairment. Given the low systemic exposure to amikacin following administration of ARIKAYCE, clinically relevant accumulation of amikacin is unlikely to occur in patients with renal impairment. However, renal function should be monitored in patients with known or suspected renal impairment, including elderly patients with potential age-related decreases in renal function [see *Warnings and Precautions (5.7)*, *Use in Specific Populations (8.5)*].

## 10 OVERDOSAGE

Adverse reactions specifically associated with overdose of ARIKAYCE have not been identified. Acute toxicity should be treated with immediate withdrawal of ARIKAYCE, and baseline tests of renal function should be undertaken.

Hemodialysis may be helpful in removing amikacin from the body.

In all cases of suspected overdosage, physicians should contact the Regional Poison Control Center for information about effective treatment. In the case of any overdosage, the possibility of drug interactions with alterations in drug disposition should be considered.

## 11 DESCRIPTION

The active ingredient in ARIKAYCE (amikacin liposome inhalation suspension) is amikacin sulfate USP, an aminoglycoside antibacterial. Its chemical name is D-Streptomine, *O*-3-amino-3-deoxy- $\alpha$ -D-glucopyranosyl-(1 $\rightarrow$ 6)-*O*-[6-amino-6-deoxy- $\alpha$ -D-glucopyranosyl-(1 $\rightarrow$ 4)]-*N*<sup>1</sup>-(4-amino-2-hydroxy-1-oxobutyl)-2-deoxy-, (*S*)-, sulfate (1:2) salt with a chemical formula of C<sub>22</sub>H<sub>43</sub>N<sub>5</sub>O<sub>13</sub>•2H<sub>2</sub>SO<sub>4</sub> with a molecular weight of 781.76. Its structural formula is:

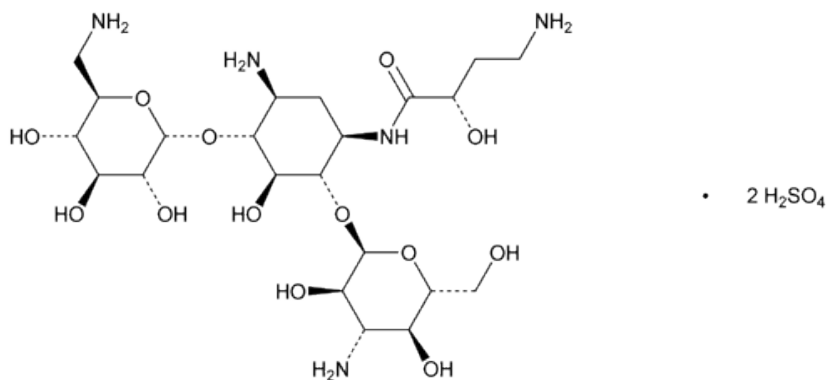

ARIKAYCE is a white milky suspension consisting of amikacin sulfate encapsulated in liposomes and is supplied in a unit-dose 10 mL clear glass vial containing amikacin 590 mg/8.4 mL (equivalent to amikacin sulfate 623 mg/8.4 mL) as a sterile aqueous liposomal suspension for oral inhalation. ARIKAYCE consists of amikacin sulfate encapsulated in liposomes at a targeted concentration of 70 mg amikacin/mL with the pH range of 6.1 to 7.1 and lipid to amikacin weight ratio in the range of 0.60 to 0.79. The inactive ingredients are cholesterol, dipalmitoylphosphatidylcholine (DPPC), sodium chloride, sodium hydroxide (for pH adjustment), and water for injection.

ARIKAYCE is administered only using a Lamira Nebulizer System [see *Dosage and Administration (2.1)*]. Like all other nebulized treatments, the amount delivered to the lungs will depend upon patient factors. Under standardized *in vitro* testing per USP<1601> adult breathing pattern (500 mL tidal volume, 15 breaths per minute, and inhalation: exhalation ratio of 1:1), the mean delivered dose from the mouthpiece was approximately 312 mg of amikacin sulfate (53% of label claim). The mass median aerodynamic diameter (MMAD) of the nebulized aerosol droplets is about 4.7  $\mu$ m (4.1 – 5.3  $\mu$ m) as determined using the Next Generation Impactor (NGI) method. A percentage of the amikacin in the liposome is released by the nebulization process, thus nebulized ARIKAYCE delivers a combination of free and liposomal amikacin.

## 12 CLINICAL PHARMACOLOGY

### 12.1 Mechanism of Action

ARIKAYCE is an antibacterial drug [see *Microbiology (12.4)*].

### 12.2 Pharmacodynamics

ARIKAYCE exposure-response relationships and the time course of pharmacodynamic response are unknown.

### 12.3 Pharmacokinetics

#### Sputum Concentrations

Following once daily inhalation of 590 mg ARIKAYCE in *Mycobacterium avium* complex (MAC) patients, sputum concentrations at 1 to 4 hours post-inhalation were 1720, 884, and 1300 mcg/g at 1, 3, and 6 months, respectively. High variability in amikacin concentrations were observed (CV% >100%). After 48 to 72 hours post-inhalation, amikacin sputum concentrations decreased to approximately 5% of those at 1 to 4 hours post-inhalation.

#### Serum Concentrations

Following 3 months of once daily inhalation of 590 mg ARIKAYCE in MAC patients, the mean serum AUC<sub>0-24</sub> was 23.5 mcg\*hr/mL (range: 8.0 to 46.5 mcg\*hr/mL; n=12) and the mean serum C<sub>max</sub> was 2.8 mcg/mL (range: 1.0 to 4.4 µg/mL; n=12). The maximum C<sub>max</sub> and AUC<sub>0-24</sub> were below the mean C<sub>max</sub> of approximately 76 mcg/mL and AUC<sub>0-24</sub> of 154 mcg\*hr/mL observed for intravenous administration of amikacin sulfate for injection at the approved dosage of 15 mg/kg once daily in healthy adults.

#### Absorption

The bioavailability of ARIKAYCE is expected to vary primarily from individual differences in nebulizer efficiency and airway pathology.

#### Distribution

The protein binding of amikacin in serum is ≤ 10%.

#### Elimination

Following inhalation of ARIKAYCE in MAC patients, the apparent serum half-life of amikacin ranged from approximately 5.9 to 19.5 hrs.

#### *Metabolism*

Amikacin does not undergo appreciable metabolism.

#### *Excretion*

Systemically absorbed amikacin following ARIKAYCE administration is eliminated principally via glomerular filtration. On average, 7.42% (ranging from 0.72 to 22.60%; n=14) of the total ARIKAYCE dose was excreted in urine as unchanged drug compared to 94% following intravenous administration of amikacin sulfate for injection. Unabsorbed amikacin, following ARIKAYCE inhalation, is probably eliminated primarily by cellular turnover and expectoration.

#### Drug Interaction Studies

No clinical drug interaction studies have been conducted with ARIKAYCE [see *Drug Interactions (7)*].

### 12.4 Microbiology

#### Mechanism of Action

Amikacin is a polycationic, semisynthetic, bactericidal aminoglycoside. Amikacin enters the bacterial cell by binding to negatively charged components of the bacterial cell wall disrupting the overall architecture of the cell wall. The primary mechanism of action is the disruption and inhibition of protein synthesis in the target bacteria by binding to the 30S ribosomal subunit.

#### Resistance

The mechanism of resistance to amikacin in mycobacteria has been linked to mutations in the *rrs* gene of the 16S rRNA. In clinical trials, MAC isolates developing an amikacin MIC of > 64 mcg/mL after baseline were observed in a higher proportion of subjects treated with ARIKAYCE [see *Clinical Studies (14)*].

#### Interaction with Other Antimicrobials

There has been no *in vitro* signal for antagonism between amikacin and other antimicrobials against MAC based on fractional inhibitory concentration (FIC) and macrophage survival assays. In select instances, some degree of synergy between amikacin and other agents has been observed, as for example, synergy between aminoglycosides, including amikacin, and the beta-lactam class has been documented.

### **13 NONCLINICAL TOXICOLOGY**

#### **13.1 Carcinogenesis, Mutagenesis, Impairment of Fertility**

In a 2-year inhalation carcinogenicity study, rats were exposed to ARIKAYCE for 15-25, 50-70, or 155-170 minutes per day for 96-104 weeks. These provided approximate inhaled doses of 5, 15, and 45 mg/kg/day. Squamous cell carcinoma was observed in the lungs of 2 of 120 rats administered the highest dose tested. Maximum serum AUC levels of amikacin in the rats at steady state were approximately 1.3, 2.8, and 7.6 mcg·hr/mL at the low, mid, and high doses, respectively, compared with 23.5 mcg·hr/mL (8.0 to 46.5 mcg·hr/mL) measured in humans. The squamous cell carcinomas may be the result of a high lung burden of particulates from ARIKAYCE in the rat lung. The relevance of the lung tumor findings with regards to humans receiving ARIKAYCE is unknown.

No evidence of mutagenicity or genotoxicity was observed in a battery of *in vitro* and *in vivo* genotoxicity studies with a liposome-encapsulated amikacin formulation similar to ARIKAYCE (*in vitro* microbial mutagenesis test, *in vitro* mouse lymphoma mutation assay, *in vitro* chromosomal aberration study, and an *in vivo* micronucleus study in rats).

No fertility studies were conducted with ARIKAYCE. Intraperitoneal administration of amikacin to male and female rats at doses up to 200 mg/kg/day prior to mating through Day 7 of gestation were not associated with impairment of fertility or adverse effects on early embryonic development.

#### **13.2 Animal Toxicology and/or Pharmacology**

To provide information about chronic dosing of ARIKAYCE to another animal species, a 9-month inhalation toxicology study was conducted in dogs. Foamy alveolar macrophages associated with clearance of the inhaled product were present at dose-related incidence and severity, but they were not associated with inflammation, tissue hyperplasia, or the presence of preneoplastic or neoplastic changes. Dogs were exposed to ARIKAYCE for up to 90 minutes per day, providing inhaled amikacin doses of approximately 5, 10, and 30 mg/kg/day.

### **14 CLINICAL STUDIES**

Trial 1 (NCT#02344004) was an open-label, randomized (2:1), multi-center trial in patients with refractory *Mycobacterium avium* complex (MAC) lung disease as confirmed by at least 2 sputum culture results. Patients were considered to have refractory MAC lung disease if they did not achieve negative sputum cultures after a minimum duration of 6 consecutive months of background regimen therapy that was either ongoing or stopped no more than 12 months before the screening visit. Patients were randomized to either ARIKAYCE plus a background regimen or background regimen alone. The surrogate endpoint for assessing efficacy was based on achieving culture conversion (3 consecutive monthly negative sputum cultures) by Month 6. The date of conversion was defined as the date of the first of the 3 negative monthly cultures, which had to be achieved by Month 4 in order to meet the endpoint by Month 6. Patients who achieved culture conversion by Month 6 were continued on study drug (ARIKAYCE plus background regimen or background regimen alone based on their randomization) for a total of 12 months after the first negative sputum culture.

A total of 336 patients were randomized (ARIKAYCE plus background regimen, n=224; background regimen alone, n=112) (ITT population), with a mean age of 64.7 years and there was a higher percentage of females (69.3%) than males (30.7%) in the study. At the time of enrollment, of the 336 subjects in the ITT population, 302 (89.9%) were either on a guideline-based regimen for MAC or off guideline-based therapy for MAC for less than 3 months while 34 (10.1%) were off treatment for 3 to 12 months prior to enrollment. At screening, patients were stratified by smoking status (current smoker or not) and by whether patients were on treatment or off treatment for at least 3 months. Most patients at screening were not current smokers (89.3%) and had underlying bronchiectasis (62.5%). At baseline, 329 patients were on

a multidrug background regimen that included a macrolide (93.3%), a rifamycin (86.3%), or ethambutol (81.4%). Overall, 55.6% of subjects were receiving a triple-drug background regimen consisting of a macrolide, a rifamycin and ethambutol.

The proportion of patients achieving culture conversion (3 consecutive monthly negative sputum cultures) by Month 6 was significantly ( $p < 0.0001$ ) greater for ARIKAYCE plus background regimen (65/224, 29.0%) compared to background regimen alone (10/112, 8.9%). Of those receiving ARIKAYCE plus background regimen, 18.3% (41/224) achieved culture conversion by Month 6 and sustained sputum culture conversion (defined as consecutive negative sputum cultures with no positive culture on solid media or no more than 2 consecutive positive cultures on liquid media following culture conversion) for up to 12 months of treatment after the first culture that defined culture conversion, compared to 2.7% (3/112) of patients receiving background regimen alone ( $p < 0.0001$ ). At 3 months after the completion of treatment, 16.1% (36/224) of patients who had received ARIKAYCE plus background regimen maintained durable culture conversion, compared to 0% of patients who had received background regimen alone ( $p < 0.0001$ ).

**Cumulative Proportion of Subjects Achieving Culture Conversion Shown by the First Month of Conversion Intent to Treat (ITT) Population**

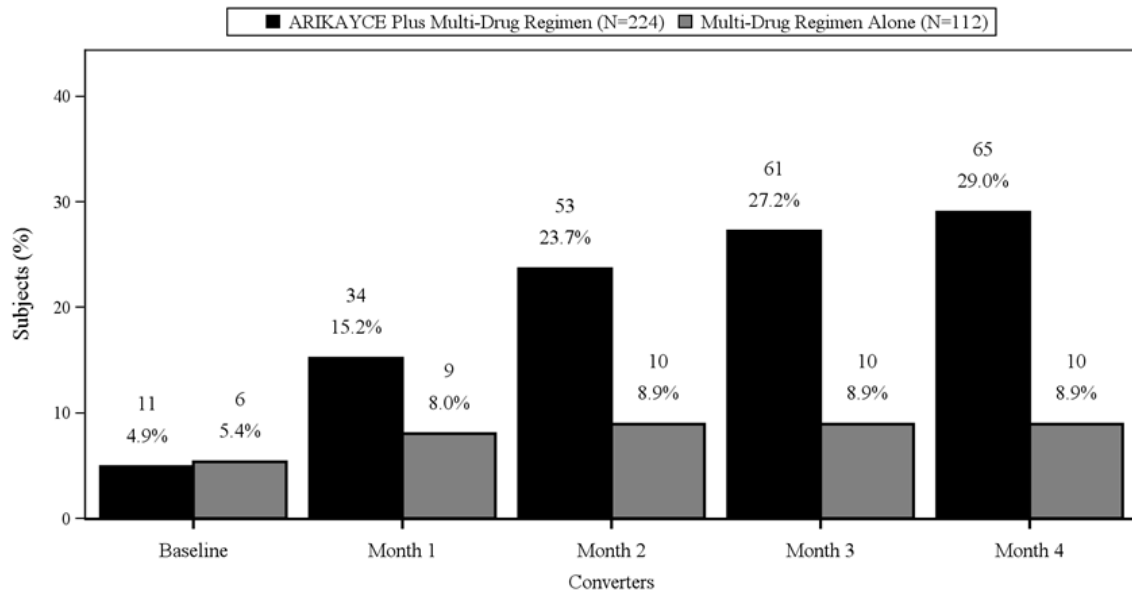

In Trial 1, 23/224 (10.3%) of patients had MAC isolates that developed MIC of  $> 64$  mcg/mL while receiving treatment with ARIKAYCE. In the background regimen alone arm, 4/112 (3.6%) of patients had MAC isolates that developed amikacin MIC of  $> 64$  mcg/mL.

Additional endpoints to assess the clinical benefit of ARIKAYCE, for example, change from baseline in six-minute walk test distance and the Saint George's Respiratory Questionnaire, did not demonstrate clinical benefit by Month 6.

## 16 HOW SUPPLIED/STORAGE AND HANDLING

### 16.1 How Supplied

ARIKAYCE (amikacin liposome inhalation suspension), 590 mg/8.4 mL, is supplied in a sterile, unit-dose 10-mL glass vial. The product is dispensed as a 28-vial kit.

Each carton contains a 28-day supply of medication (28 vials). In addition to the ARIKAYCE vials in the carton, one Lamira Nebulizer Handset and four Lamira Aerosol Heads are provided.

NDC 71558-590-28

The Lamira Nebulizer System contains a controller, a spare Aerosol Head, a spare Handset, Power Cord and accessories.

### 16.2 Storage and Handling

Store ARIKAYCE vials refrigerated at  $2^{\circ}\text{C}$  to  $8^{\circ}\text{C}$  ( $36^{\circ}\text{F}$  to  $46^{\circ}\text{F}$ ) until expiration date on vial. *Do not freeze.* Once expired, discard any unused drug.

ARIKAYCE can be stored at room temperature up to 25°C (77°F) for up to 4 weeks. Once at room temperature, any unused drug must be discarded at the end of 4 weeks.

## 17 PATIENT COUNSELING INFORMATION

Advise the patient to read the FDA-approved patient labeling (Medication Guide and Patient Instructions for Use).

### Important Instructions for Administration of ARIKAYCE

Instruct patients to read the *Instructions for Use* before starting ARIKAYCE. Instruct patients to only use the Lamira® Nebulizer System to administer ARIKAYCE. Advise the patient or caregiver not to use the Lamira Nebulizer System with any other medicine.

### Hypersensitivity Pneumonitis and Bronchospasm (Difficulty Breathing)

Advise patients to inform their healthcare provider if they experience shortness of breath or wheezing after administration of ARIKAYCE. Advise patients with a history of reactive airway disease, asthma, or bronchospasm, to administer ARIKAYCE after using a short-acting bronchodilator [see *Warnings and Precautions (5.1, 5.3)*].

### Hemoptysis or Cough

Advise patients to inform their healthcare provider if they cough up blood or experience episodic cough either during or after ARIKAYCE administration particularly in the first month after starting ARIKAYCE [see *Warnings and Precautions (5.2) and Adverse Reactions (6.1)*].

### Exacerbations of Underlying Pulmonary Disease

Advise patients to inform their healthcare provider if they experience worsening of their lung disease after starting ARIKAYCE [see *Warnings and Precautions (5.4)*].

### Dysphonia or Difficulty Speaking

Advise patients to inform their healthcare provider if they have difficulty speaking. Difficulty speaking or loss of ability to speak has been reported with ARIKAYCE [see *Adverse Reactions (6.1)*].

### Anaphylaxis and Hypersensitivity Reactions

Advise patients and caregivers that serious and potentially life-threatening hypersensitivity reactions, that require immediate treatment could occur. Advise the patient to discontinue ARIKAYCE and seek immediate medical attention if any signs or symptoms of a hypersensitivity reaction occur [see *Warnings and Precautions (5.5)*].

### Ototoxicity (Ringing in the Ears)

Advise patients to inform their healthcare provider if they experience ringing in the ears, dizziness, or any changes in hearing because ARIKAYCE has been associated with hearing loss [see *Warnings and Precautions (5.6)*].

Advise the patient not to operate heavy machinery or do dangerous activities while inhaling ARIKAYCE through the Lamira Nebulizer System because ARIKAYCE can cause symptoms such as dizziness or respiratory symptoms.

### Nephrotoxicity or Kidney Damage

Advise patients to inform their health care provider if they have kidney problems because kidney damage has been reported with aminoglycosides [see *Warnings and Precautions (5.7)*].

### Neuromuscular Blockade

Advise patients to inform their healthcare provider of known neuromuscular disease (e.g., myasthenia gravis) [see *Warnings and Precautions (5.8)*].

### Embryo-Fetal Toxicity

Advise pregnant women that aminoglycosides, including ARIKAYCE, may cause irreversible congenital deafness when administered during pregnancy [see *Warnings and Precautions (5.9) and Use in Special Populations (8.1)*].

Manufactured for:

Insmed<sup>®</sup>, Bridgewater, NJ 08807

Insmed<sup>®</sup> and, ARIKAYCE<sup>®</sup> are trademarks of Insmed Incorporated. Lamira<sup>®</sup> is a trademark of PARI Pharma GmbH.

© Insmed Incorporated. All rights reserved. 2010 7,718,189; 2012 8,226,975; 2014 8,632,804, 8,642,075, 8,679,532 and 8,802,137; 2017 9,566,234 and 9,827,317 and 2018 9,895,385.

**MEDICATION GUIDE**  
**ARIKAYCE (ar' i kase) LIMITED POPULATION**  
(amikacin liposome inhalation suspension)  
for oral inhalation use

**Important: For oral inhalation only.**

**What is the most important information I should know about ARIKAYCE?**

**ARIKAYCE can cause serious side effects, including:**

- **allergic inflammation of the lungs:** These respiratory problems may be symptoms of allergic inflammation of the lungs and often come with:
  - fever
  - coughing
  - fast breathing
  - wheezing
  - shortness of breath
- **coughing up of blood (hemoptysis):** Coughing up blood is a serious and common side effect of ARIKAYCE.
- **severe breathing problems:** Severe breathing problems can be symptoms of bronchospasm. Bronchospasm is a serious and common side effect of ARIKAYCE. Bronchospasm symptoms include:
  - shortness of breath
  - wheezing
  - difficult or labored breathing
  - coughing or chest tightness
- **worsening of chronic obstructive pulmonary disease (COPD):** This is a serious and common side effect of ARIKAYCE.
- **serious allergic reactions:** Serious allergic reactions that may lead to death have happened to people who take ARIKAYCE. Stop taking ARIKAYCE right away and get emergency medical help if you have any of the following symptoms of a serious allergic reaction:
  - hives
  - itching
  - redness or blushing of the skin (flushing)
  - swollen lips, tongue or throat
  - trouble breathing or wheezing
  - shortness of breath
  - noisy high-pitched breathing (stridor)
  - cough
  - nausea
  - vomiting
  - diarrhea
  - feel cramps in your stomach area
  - fast heart rate
  - feeling light headed
  - feeling faint
  - loss of control of the bowels or bladder (incontinence)
  - dizziness

**While using ARIKAYCE these side effects may become serious enough that treatment in a hospital is needed.**

**Call your healthcare provider or get medical help right away if you have any of these serious side effects while taking ARIKAYCE.** Your healthcare provider may ask you to stop using ARIKAYCE for a short period of time or completely stop using ARIKAYCE.

**What is ARIKAYCE?**

ARIKAYCE is a prescription medicine used to treat adults with refractory (difficult to treat) *Mycobacterium avium* complex (MAC) lung disease as part of a combination antibacterial drug treatment plan (regimen).

It is not known if ARIKAYCE is safe and effective in children younger than 18 years of age.

This product was approved by FDA using the Limited Population pathway. This means FDA has approved this drug for a limited and specific patient population, and studies on the drug may have only answered focused questions about its safety and effectiveness.

**Do not use ARIKAYCE if you:**

- are allergic to any aminoglycoside, or any of the ingredients in ARIKAYCE. See **“What are the ingredients in ARIKAYCE?”** at the end of this leaflet for a complete list of ingredients in ARIKAYCE.

**Before using ARIKAYCE, tell your healthcare provider about all of your medical conditions, including if you:**

- have asthma, chronic obstructive pulmonary disease (COPD), shortness of breath or wheezing (bronchospasm).
- have been told you have poor lung function.
- have hearing problems such as ringing in your ears or hearing loss.
- have dizziness or sense of the room spinning.
- have kidney problems.
- have neuromuscular disease such as myasthenia gravis.
- are pregnant or plan to become pregnant. It is not known if ARIKAYCE can harm your unborn baby. ARIKAYCE is in a class of medicines that may be connected with complete deafness in babies at birth. The deafness affects both ears and cannot be changed.
- are breastfeeding or plan to breastfeed. It is not known if the medicine in ARIKAYCE passes into your breast milk and if it can harm your baby. Talk to your healthcare provider about the best way to feed your baby during treatment with ARIKAYCE.

**Tell your healthcare provider about all the medicines you take, including** prescription medicines and over-the-counter medicines, vitamins, and herbal supplements.

**How should I use ARIKAYCE?**

- **Read the step-by-step instructions for using ARIKAYCE at the end of the Medication Guide and the full Instructions for Use provided in your kit.** The manufacturer's Instructions for Use provides complete information about how to put together (assemble), prepare, use, clean, and disinfect your Lamira® Nebulizer System.
- **Do not** use ARIKAYCE unless you understand the directions provided. If you have questions talk to your health care provider or call Arikares Support at 1-833-ARIKARE (1-833-274-5273).
- Use ARIKAYCE exactly as your healthcare provider tells you to use it. Do not use ARIKAYCE more often than prescribed for you.
- Only use ARIKAYCE with the Lamira Nebulizer System.
- Inhale each daily dose of ARIKAYCE 1 time each day through the Lamira Nebulizer Handset. **Do not** use more than 1 vial of ARIKAYCE in a day.
- Do not use ARIKAYCE after the expiration date on the vial. If you forget to take your daily dose of ARIKAYCE, take your next dose at your usual time the next day.
- **Do not** double the dose to make up for the missed dose.
- **Do not** stop using ARIKAYCE or other medicines to treat your MAC lung disease unless told to do so by your healthcare provider.
- If you use too much ARIKAYCE, call your healthcare provider or go to the nearest emergency room right away.

**What are the possible side effects of ARIKAYCE?**

**ARIKAYCE may cause serious side effects, including:**

- **See “What is the most important information I should know about ARIKAYCE?”**
- **hearing loss or ringing in the ears (ototoxicity).** Ototoxicity is a serious and common side effect of ARIKAYCE. Tell your healthcare provider right away if you have hearing loss or you hear noises in your ears such as ringing or hissing. Tell your healthcare provider if you start having problems with balance or dizziness (vertigo).
- **worsening kidney problems (nephrotoxicity).** ARIKAYCE is in a class of medicines which may cause worsening kidney problems. Your healthcare provider may do a blood test to check how well your kidneys are working during your treatment with ARIKAYCE.
- **worsening muscle weakness (neuromuscular blockade).** ARIKAYCE is in a class of medicines which can cause muscle weakness to get worse in people who already have problems with muscle weakness (myasthenia gravis).

**The most common side effects of ARIKAYCE include:**

- changes in your voice and hoarseness (dysphonia)
- sore throat
- diarrhea
- muscle pain
- nausea



- tiredness (fatigue)
- headache
- rash
- cough during or after a dose of ARIKAYCE, especially in the first month after starting treatment.
- fever
- decreased weight
- chest discomfort
- vomiting
- increased sputum

These are not all of the possible side effects of ARIKAYCE.

Call your doctor or pharmacist for medical advice about side effects. You may report side effects to FDA at 1-800-FDA-1088

#### **How should I store ARIKAYCE?**

- Store ARIKAYCE vials refrigerated between 36°F to 46°F (2°C to 8°C) until the expiration date on the vial. Do not freeze.
- After ARIKAYCE has been stored in the refrigerator, any unused medicine must be thrown away (disposed of) after the expiration date on the vial.
- Store ARIKAYCE vials at room temperature between 68°F to 77°F (20°C to 25°C) for up to 4 weeks
- After ARIKAYCE has been stored at room temperature any unused medicine must be thrown away (disposed of) at the end of 4 weeks.
- Use an opened ARIKAYCE vial right away.
- Throw away the ARIKAYCE vial right away after use.

#### **Keep ARIKAYCE and all medicines out of the reach of children.**

#### **General information about safe and effective use of ARIKAYCE**

Medicines are sometimes prescribed for purposes other than those listed in a Medication Guide. Do not use ARIKAYCE for a condition for which it was not prescribed. Do not give ARIKAYCE to other people even if they have the same symptoms that you have. It may harm them. You can ask your pharmacist or healthcare provider for information about ARIKAYCE that is written for health professionals.

#### **What are the ingredients in ARIKAYCE?**

**Active ingredient:** amikacin sulfate

**Inactive ingredients:** Dipalmitoylphosphatidylcholine (DPPC), cholesterol, sodium chloride, sodium hydroxide (for pH adjustment), and water for injection

Manufactured for: Insmmed Incorporated, 700 US Highway 202/206, Bridgewater, NJ 08807-1704

Insmmed Incorporated, All rights reserved.

For more information, call Insmmed Arikares Support at: 1- 833-ARIKARE (1-833-274-5273)

This Medication Guide has been approved by the U.S. Food and Drug Administration

Issued: 02/2020

## Instructions for Use

### ARIKAYCE® LIMITED POPULATION (amikacin liposome inhalation suspension)

#### For oral inhalation use Lamira™ Nebulizer System

Before using your Lamira Nebulizer System, be sure you read and understand the detailed information in the full Instructions for Use that comes with the Lamira Nebulizer System. This will provide more complete information about how to put together (assemble), prepare, use, clean, and disinfect your Lamira Nebulizer System. If you do not understand any part of the instructions, contact **Arikares Support at 1-833-ARIKARE (1-833-274-5273)** before using the Lamira Nebulizer System.

#### Gather your ARIKAYCE medicine. The ARIKAYCE 28-day kit contains:

- 1 ARIKAYCE Quick Start Guide
- 1 Instructions for Use insert
- 1 Full Prescribing Information insert
- 1 Lamira Nebulizer Handset
- 4 Lamira Aerosol Heads (1 in each weekly box)
- 28 vials (1 vial each day) of ARIKAYCE (7 in each weekly box)

#### Check to make sure you have all the necessary parts for your Lamira Nebulizer System:

- a. Carrying Case
- b. Connection Cord
- c. Controller
- d. A/C Power Supply
- e. "AA" Batteries

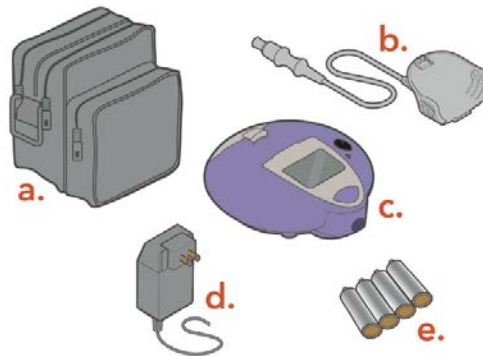

#### Spare Lamira Nebulizer Handset:

- f. Medication Cap and Seal
- g. Medication Reservoir
- h. Blue Valve
- i. Aerosol Chamber
- j. Mouthpiece
- k. Spare Aerosol Head

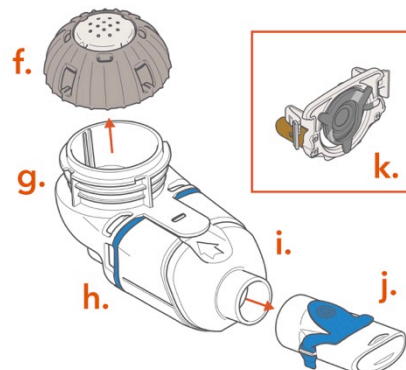

You will also need the following supplies that do not come in your ARIKAYCE 28-day kit that will help you care for your Lamira Nebulizer System:

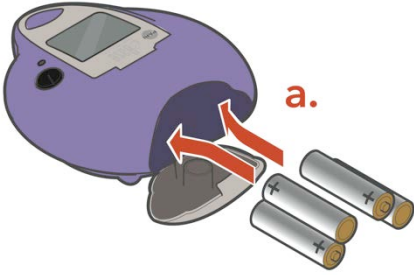
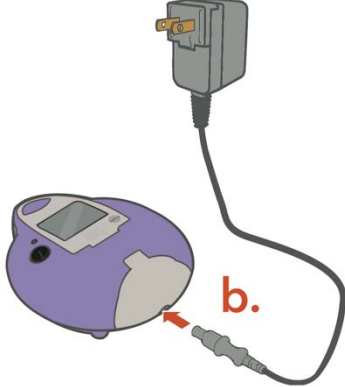
<ul style="list-style-type: none"> <li>• Clear liquid soap for cleaning the Handset and Aerosol Head</li> <li>• Distilled water for disinfecting the Handset and Aerosol Head</li> </ul>	
<p><b>Choose your power supply and get it ready.</b></p>	
<p><b>a. 4 “AA” batteries</b></p>	
<p><b>or</b></p>	
<p><b>b. A/C Power Supply</b></p> <ul style="list-style-type: none"> <li>• Plug the A/C Power Supply into the Controller.</li> <li>• Plug the A/C Power Supply into the wall outlet.</li> </ul> <p><b>Do not insert the A/C Power into the front of the Controller.</b></p>	

### Cleaning and Disinfecting

**Clean and disinfect your Handset and Aerosol Head before you use it for the first time, and immediately after each use.**

When you receive your Handset and Aerosol Head, they will not be sterile. Cleaning and disinfecting your Handset and Aerosol Head is important to reduce the risk of infection, illness, and contamination.

<p><b>1. Cleaning the Handset and Aerosol Head Reminder:</b> Clean the Handset and Aerosol Head before first use and immediately after each use.</p>	
<ul style="list-style-type: none"> <li>• Take apart (disassemble) the Handset for cleaning</li> <li>• <b>Gently wipe away any drops of medicine</b> from the</li> </ul>	

Medication Reservoir (a), Aerosol Chamber (b), and Mouthpiece (c) before rinsing, to reduce antibiotics added to water systems.

**Use only plain, dry paper towels or wipes.** Do not use towels or wipes that have any chemicals added to them such as alcohol, lotion, or baby wipes.

**Be careful not to harm the parts. Do not wipe Aerosol Head.**

**Throw away paper towels by disposing in trash with solid waste.**

- Rinse each of the parts under warm running tap water for **10 seconds**. Rinse the Aerosol Head for **10 seconds on each side**.

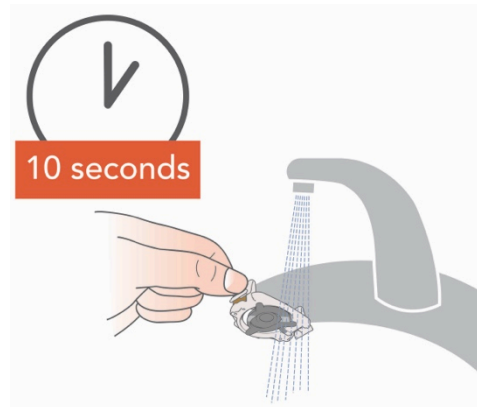
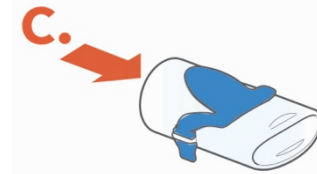
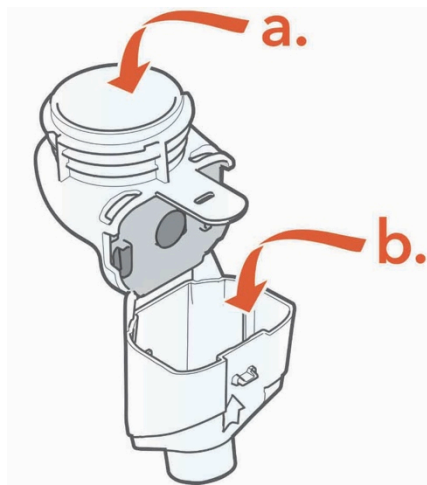

- Clean all Handset parts by adding a few drops of clear liquid dish soap and warm tap water to a clean tub or bowl. Cover the Handset parts in the warm soapy water and soak for **5 minutes**, shaking them periodically. Then rinse them thoroughly under warm running tap water.

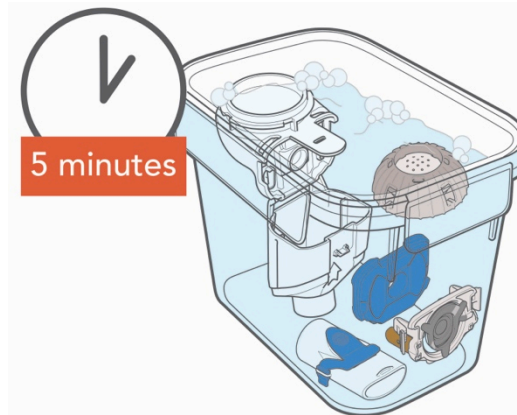

## 2. Disinfecting the Handset and Aerosol Head Before First Use

**Reminder:** Disinfect the Handset and Aerosol Head before first use.

- Be sure your Handset and Aerosol Head are clean before you disinfect.
- Boil the Handset parts, including the Aerosol Head, in a clean pot of **distilled** water for a full **5 minutes**.

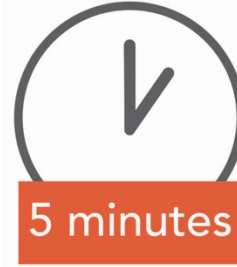

- Air dry on a **lint-free** towel. When fully dry, wrap up the parts in a lint-free towel for storage. You can put them together again just before taking your next treatment.

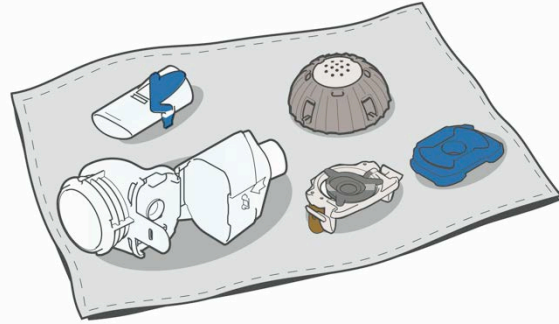

### Assembling Your Handset

**Step 1: Wash your hands with soap and water, and dry them well.**

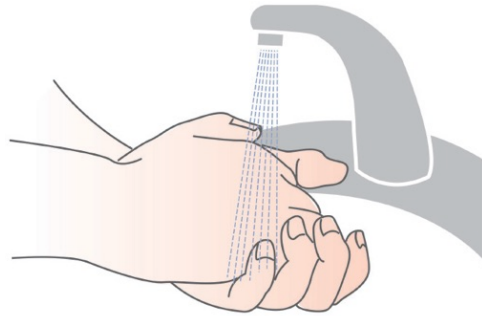

**Step 2: Insert the Blue Valve.**

Open the Handset by gently pulling up on the tab of the Medication Reservoir.

Insert the Blue Valve so that it rests on top of the Aerosol Chamber with the 2 valve flaps facing down.

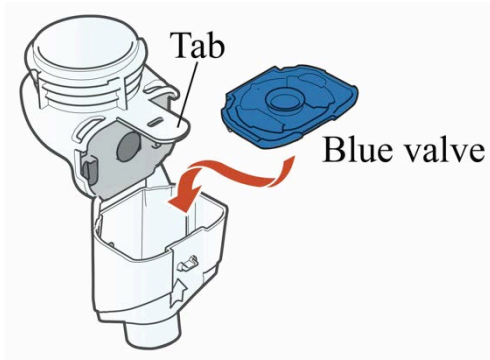

**Step 3: Insert the Aerosol Head.**

Grasp the Aerosol Head by the 2 flexible plastic tabs on each side. Be sure the text "For amikacin liposome

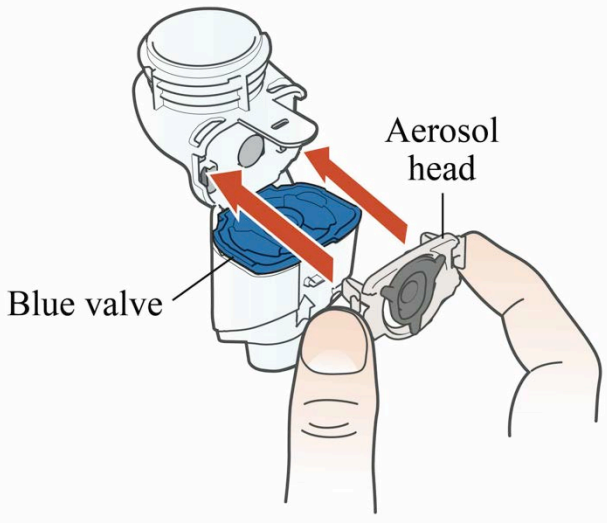
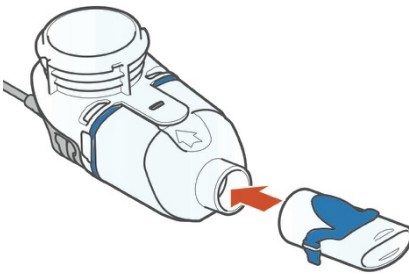
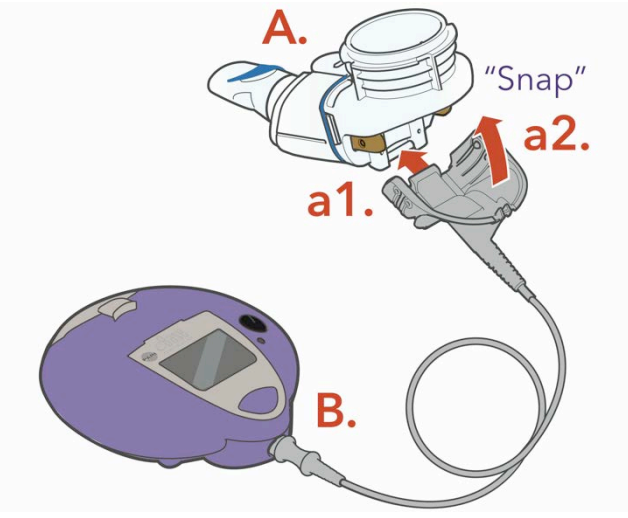
<p>inhalation suspension” is facing toward you and is at the top of the Aerosol Head.</p> <p>Squeeze the 2 flexible plastic tabs together while inserting the Aerosol Head into the Medication Reservoir.</p> <p>Close the Handset when you are done.</p> <p><b>Do not touch the silver part of the Aerosol Head at any time.</b></p> <p><b>After the Aerosol Head has been used 7 times, throw away (dispose of) and replace with a new one during the cleaning process.</b></p>	
<p><b>Step 4: Attach the Mouthpiece to your Handset with the Blue Flap facing up.</b></p>	
<p><b>Step 5: Finally, attach the Handset to the Controller.</b></p> <p><b>a. Attach the Connection Cord to the Handset.</b></p> <p>a1. Line up the bottom of the Connector with the bottom of the Handset.</p> <p>a2. Push upward against the Handset until you hear the pieces snap together.</p> <p><b>b. Connect the Connection Cord to the Controller.</b></p>	

### Taking ARIKAYCE

Your ARIKAYCE should be at room temperature before use to make sure that your Lamira Nebulizer System operates properly. **Do not use other medicines in your Handset.**

Bring ARIKAYCE to room temperature by removing it from the refrigerator at least 45 minutes before use. **Do not use if your ARIKAYCE has been frozen.**

**Step 1: Get your ARIKAYCE ready.**

- Place the Handset on a clean, flat, stable surface.
- Shake the ARIKAYCE vial well for **at least 10 to 15 seconds**, until the medicine looks the same throughout and well mixed.



**How to open the ARIKAYCE vial**

- **Lift the orange cap** from the vial.
- **Grip the metal ring** on top of the vial and pull it down gently until 1 side breaks away from the vial.
- **Pull the metal band** from around the vial top in a circular motion until it comes off completely.
- **Carefully remove** the rubber stopper.

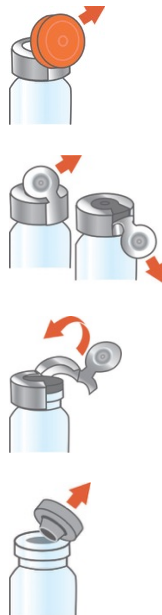

- a. Open the vial and pour the ARIKAYCE into the Medication Reservoir.
- b. Attach the Medication Cap.

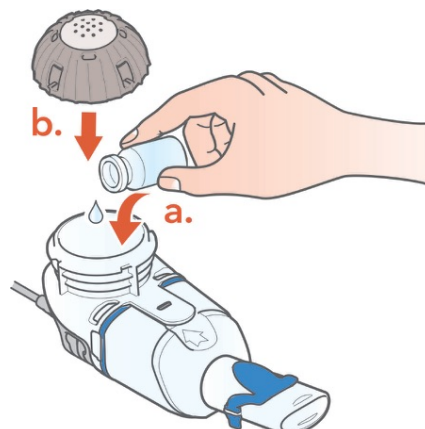

**Step 2: Sit in a relaxed, upright position.**

- Press and hold down on the On/Off button for a few seconds to turn the Lamira on.
- Mist will begin to flow.

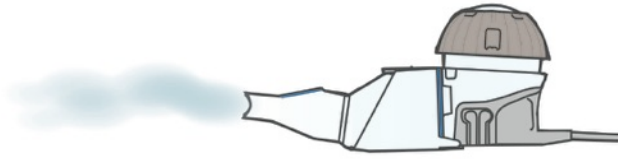

**Step 3: Insert the Mouthpiece and take slow, deep breaths.**

- Then, breathe normally in and out through the Mouthpiece until your treatment is complete.
- Treatment should take about 14 minutes but could take up to 20 minutes.

**Be sure to hold the Handset level throughout the treatment.**

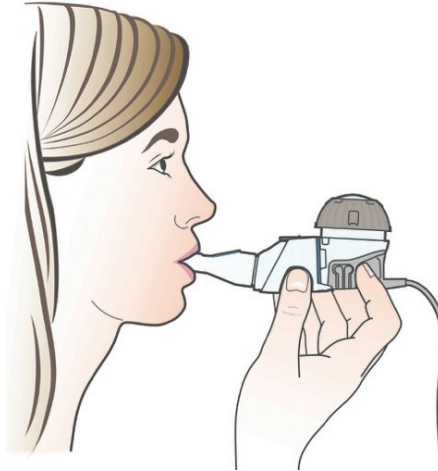

**Step 4: Check that your treatment has ended.**

- The Lamira will beep 2 times.
- The LED light will flash red 2 times.
- A Checkmark will briefly appear on the screen.
- The Controller will automatically shut off.
- Remove the Medication Cap and **check the Medication Reservoir to make sure that no more than a few drops of ARIKAYCE remains. If ARIKAYCE remains, replace the Medication Cap, press the On/Off button, and complete your dose.**

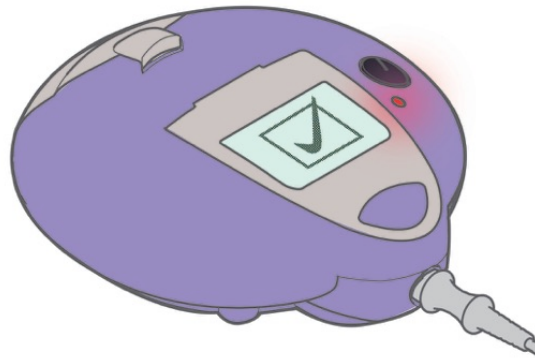



**For any issues you may have with your Lamira Nebulizer System, see Section K – Troubleshooting of the full Instructions for Use that comes with your medicine.**

#### **Cleaning your Lamira Handset and Aerosol Head After Use**

- **Rinse, clean, and disinfect handset right away after each use to reduce infection, illness, and contamination.**
- **Disinfect the Handset and Aerosol Head every day.**
- **See “Cleaning and Disinfecting” at the beginning of the Instructions for Use on how to properly clean and disinfect your handset and aerosol head.**

This Instructions for Use has been approved by the U.S. Food and Drug Administration.

Issued: 09/2018



# LAMIRA™ NEBULIZER SYSTEM

## INSTRUCTIONS FOR USE



### ▲ WARNING

Read and understand these **Instructions For Use** and all safety precautions it contains. Improper use can cause serious or fatal injury or illness.

### ▲ WARNING

Read and understand the **Prescribing Information** leaflet for information and warnings for the drug ARIKAYCE.

For use only with:

  
**ARIKAYCE®**  
(amikacin liposome  
inhalation suspension)

**Limited Population\***



**Prescription Only**

Assembly required. ARIKAYCE vials packaged separately.  
\*See the full prescribing information for ARIKAYCE for information about the limited population.

## Table of Contents

A. Introduction	1
B. Safety Precautions	2
C. Getting Started	3
D. Using Batteries or the A/C Power Supply	4
E. Maintaining Your Lamira	5
F. Cleaning Your Lamira	6
G. Disinfecting Your Lamira	9
H. Assembling your Lamira Handset	10
I. Taking ARIKAYCE	13
J. Frequently Asked Questions	16
K. Troubleshooting	17
L. Specifications	19

## Introduction

The Lamira™ Nebulizer System (Lamira) is a battery operated electronic nebulizer, which vibrates and forces liquid ARIKAYCE through thousands of small holes to form an aerosol mist for inhalation.

These Instructions for Use contain information and safety precautions for the Lamira nebulizer that is made just for the medicine ARIKAYCE® (amikacin liposome inhalation suspension). **Do not** use any other medicine in the Lamira nebulizer.

### Warning

Before using your Lamira nebulizer, read and understand all the Instructions for Use and save them for future reference. If you do not understand any part of these directions, contact the Arikares Support Program at 1-833-ARIKARE (1-833-274-5273) before using the Lamira nebulizer.

To reduce the risk of infection, illness, or injury from contamination or improper use, it is important to complete the following 2 steps:

- 1) Rinse and clean the Handset including the Aerosol Head before first use and right after each use.** (see Section F) Do not wash the Controller, Connection Cord, or A/C Power Supply. Use clear liquid soap made for washing dishes to clean the Handset including the Aerosol Head. Do not use liquid dish soaps that are white or antibacterial liquid dish soaps because these may contain additives harmful to the Aerosol Head.
- 2) Disinfect the Handset including the Aerosol Head every day (see Section G).**

Take special note of all safety precautions marked **Danger and Warning**.

### Indications for use

Limited by Federal Law for use only with ARIKAYCE.

# B Safety Precautions

Read all dangers and warnings before using.

## Danger

To reduce the risk of fatal injury from electrocution:

- **Do not** place or store the Lamira Nebulizer System near water or other liquid such as bathtub or sink. **Do not** place or drop into water or other liquid. **Do not** use while bathing.
- **Do not** reach for the Lamira Nebulizer System if it has fallen into water or other liquid. Unplug right away. Pick up the Lamira only after it has been unplugged.

## Warning

To reduce the risk of serious injury:

- The Lamira Nebulizer Handset (Handset) is for single patient use. **Do not** share your Handset with other people.
- The Handset is made just for ARIKAYCE. Never use other medicine in the Handset. Using other medicine in the Lamira nebulizer can result in severe injury or death.
- Read, understand and follow all warnings and instructions in these Instructions for Use before using the Lamira nebulizer.
- To reduce the risk of fire, burns and damage or malfunction of the Controller:
  - ✓ **Do not** overload wall outlets or use extension cords.
  - ✓ Keep all electrical cords away from heated surfaces.
  - ✓ **Do not** spray liquids onto the housing of the Controller (Controller). (See Section C: Getting Started) Liquid may cause damage to the electrical parts and could lead to a malfunction. If liquids enter the Controller, contact the Arikares Support Program at 1-833-ARIKARE (1-833-274-5273).
  - ✓ **Do not** insert any object into any opening on the Lamira.
  - ✓ **Do not** operate where oxygen is being given in a closed environment such as an oxygen tent.
- Always unplug the Lamira right after using and before cleaning.
- Before use, check your Lamira for proper assembly. All parts must be connected and firmly in place. Use of an improperly assembled Lamira could decrease or stop the effectiveness of your treatment.
- Use only adapters and accessories that are made for the Lamira. Use of unapproved adapters or accessories can lead to improper administration, injury, leading to damage to the Controller.
- Never substitute the Handset for any other eFlow® Technology Handset such as Altera®, eRapid® or any other eFlow®. Never use the Lamira Aerosol Head (Aerosol Head) in any other eFlow® Technology Handset. This Aerosol Head has unique performance characteristics for ARIKAYCE.
- Never operate the Controller if it is improperly or incompletely assembled or damaged. See Section K: Troubleshooting for more information about alerts that appear when the Lamira is improperly assembled or might be damaged.
- Never operate the Lamira if:
  - ✓ It has damaged cords or plugs,
  - ✓ it is not working properly,
  - ✓ it has been dropped or damaged,
  - ✓ the Controller has been exposed to liquids

- To reduce the risk of infection, illness, or injury from contamination, clean and dry all parts of the Handset after each use. Follow the instructions in Section E to maintain and clean the Lamira.
- Cleaning the Handset properly will help prevent the Aerosol Head from clogging. **Replace the Aerosol Head with a new one after 7 uses.** If the Aerosol Head becomes clogged, the aerosol mist will be reduced, which may increase your inhalation time of therapy. If clogging occurs, use the instructions in Section F to clean the Aerosol Head.
- Cleaning the Handset and Aerosol Head only removes the medicine and saliva. To reduce the risk of serious or fatal illness caused by contamination of the Handset, you must also disinfect the Handset and Aerosol Head after every cleaning. See Section G for disinfection instructions.
- The Lamira contains small parts that may become a choking hazard to small children. The Lamira Connection Cord (Connection Cord) also may become a strangulation hazard.
- **Do not** allow pets, for example dogs or rodents, near the cables.
- Keep the Lamira out of reach of children.
- Keep the Handset level when in use. Excessive tilting can cause the Controller to shut off leaving unused ARIKAYCE in the Medication Reservoir and resulting in incomplete dosing.
- Closely supervise use when the Lamira is used near children or the physically or mentally impaired.
- **Do not** use your Lamira while driving or in any situation which takes away your full attention.
- If the Lamira has been damaged or is not operating properly, contact the Arikares Support Program at 1-833-ARIKARE (1-833-274-5273).
- **Do not** take the Controller apart at any time. There are no user serviceable parts inside the Controller. Contact the Arikares Support Program at 1-833-ARIKARE (1-833-274-5273) for all Controller service needs.
- **Do not** modify this equipment without authorization from the manufacturer.
- **Do not** use the device in areas exposed to elevated electromagnetic or electrical radiation such as a MRI scanner or high frequency surgical equipment.
- **Do not** place near other medical devices during operation unless both devices are monitored constantly to make sure both are operating properly.
- **Do not** use within 12 inches (30 cm) of portable wireless communication devices such as cell phones or antenna cables or external antennas.
- **Do not** use near airplane or train control systems. Do not use aboard aircraft.
- **Do not** use the nebulizer near anti-theft systems and Radio Frequency Identification (RFID) readers, which are used in a wide variety of settings, including stores, libraries, and hospitals. Do not power on the nebulizer when passing through security screening or theft protection (RFID) systems at entrances or exits of stores, libraries or hospitals. Note that some entrance and exit security systems are not visible.

Technical electromagnetic compatibility data is available in table form upon request from PARI Pharma GmbH or on the internet at <https://www.pari.com/fileadmin/Electromagnetic-compatibility-4.pdf>

## C

## Getting Started

## Step C1: Gather your dosing supplies:

- Clear liquid soap for cleaning the Handset
- Distilled water for disinfecting the Handset
- The ARIKAYCE 28-day drug kit will contain the following:
  - 28 vials of ARIKAYCE (1 vial to be used each day for 28 days)
  - 4 Lamira Aerosol Heads (1 Aerosol Head to be used for 7 days and then replaced)
  - 1 Lamira Handset (to be used for 28 days until the next ARIKAYCE drug box arrives)
  - 1 ARIKAYCE Quick Start Guide
  - 1 Instructions For Use Insert
  - 1 Full Prescribing Information Insert

Step C2: Check your Lamira Nebulizer System package to make sure you have the items shown below. Note that the package contains a Handset that should be set aside as a spare. If anything looks damaged, contact the Arikares Support Program at 1-833-ARIKARE (1-833-274-5273).

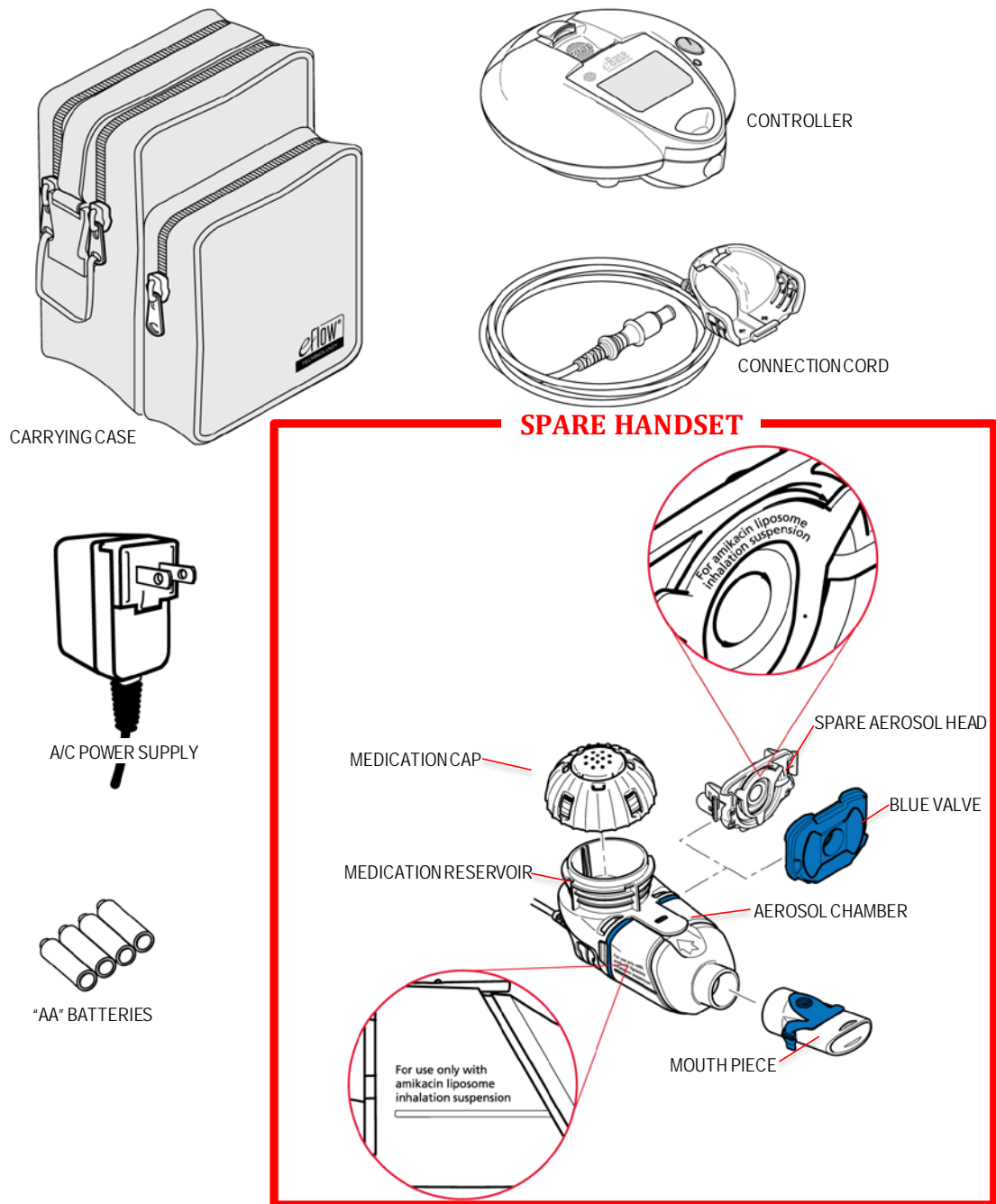

# D

## Using Batteries or the A/C Power Supply

The Lamira is made to be used with “AA” batteries or with the A/C Power Supply.

**Using Batteries:** Four (4) high quality “AA” batteries should provide 2 hours of total use.

**Step D1:** **Open the Battery Door** on the Controller by placing your thumb on the tab of the Battery Door and firmly pulling the tab to open the Door (D-1).

**Step D2:** **Load the Batteries.** Each Battery Chamber has a small figure that shows the proper position of each battery (D-2). Using the battery “tips” as guides and starting left-to-right for each row, insert the batteries: Tip Out, Tip In, Tip Out, Tip In.

**Close the Battery Door.** To close the Battery Door, push it closed until you hear it “click” into place.

**NOTE:** Rechargeable and Disposable Batteries have differences in storage life and output. If you plan to store the Controller for more than 30 days, it is recommended to remove the batteries to reduce the risk of battery leakage.

If you choose not to use the A/C Power Supply, you should have an extra battery set with you at all times.

**Using the A/C Power Supply:** The A/C Power Supply will automatically adjust to the incoming voltage and will power the Controller with or without installed batteries. It can be used worldwide, but requires “Plug Converters” for use outside the USA.

**Step D3:** **Plug the A/C Power Supply into the Controller.** To connect the A/C Power Supply to the Controller, place the Controller on a clean, flat, stable surface. The plug inlet port is located on the underside of the gray Battery Door. Push the round end of the A/C Power Supply plug into the plug inlet port (D-3). **Do not** try to insert the A/C Power Supply into the front of the Controller.

**Step D4:** **Plug the A/C Power Supply into the wall outlet.** Note that the A/C Power Supply will not charge the batteries in the Controller.

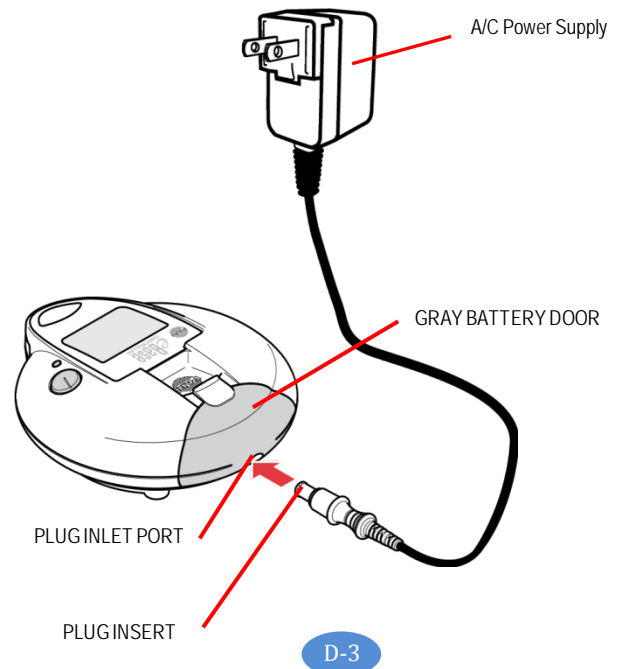
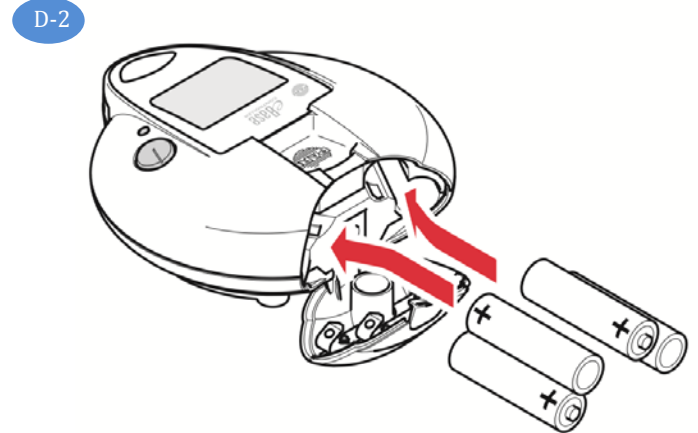
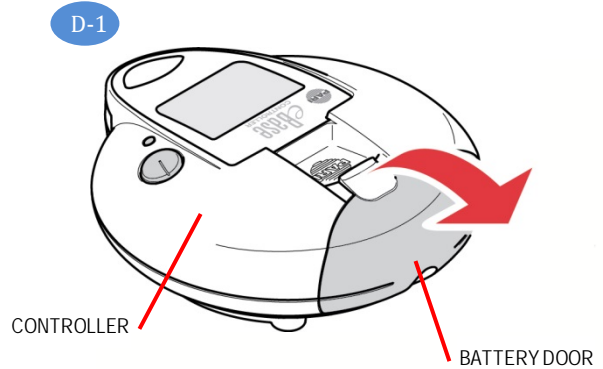

# E

## Maintaining Your Lamira

### Warning

To reduce the risk of infection, illness, or injury from contamination or improper use, it is important to complete the following 2 steps:

- 1) Rinse and clean the Handset including the Aerosol Head before first use and right after each use. (see Section F) Do not wash the Controller, Connection Cord, or A/C Power Supply. Use clear liquid soap made for washing dishes to clean the Handset. Do not use liquid dish soaps that are white or antibacterial liquid dish soaps because these may contain additives harmful to the Aerosol Head.
- 2) Disinfect the Handset every day (see Section G).

### Caution

- Do not put the Handset or the Aerosol Head in the microwave oven.
- Do not try to clean the Handset or Aerosol Head in a dishwasher.
- Do not try to clean the Handset or the Aerosol Head with brushes or abrasives.

## Handset Maintenance Summary (see the next page for complete instructions)

Instruction	When	Parts cleaned	Method	How Long	Comments
Wipe	After each use	<ul style="list-style-type: none"> <li>• Medication Reservoir and Aerosol Chamber</li> <li>• Mouthpiece</li> </ul>	Wipe with clean disposable paper towel.	1 second per part	Wipe to remove residual medicine and then dispose of paper towel in trash with solid waste.
Rinse	Prior to first use and after each use	<ul style="list-style-type: none"> <li>• Aerosol Head</li> <li>• Medication Cap and Seal</li> <li>• Blue Valve</li> <li>• Medication Reservoir and Aerosol Chamber</li> <li>• Mouthpiece</li> </ul>	Warm running tap water.	10 seconds	Rinse each side of the Aerosol Head for 10 seconds.
Clean	Prior to first use and after each use	<ul style="list-style-type: none"> <li>• Aerosol Head</li> <li>• Medication Cap and Seal</li> <li>• Blue Valve</li> <li>• Medication Reservoir and Aerosol Chamber</li> <li>• Mouthpiece</li> </ul>	Soak each piece in warm soapy water.  While soaking swish or shake each piece.	5 minutes	Use 3 to 5 drops of clear liquid dish soap in a bowl with enough warm water to cover all pieces.  Soak longer if Handset has dried or if visibly dirty.
Rinse	Prior to first use and after each use	<ul style="list-style-type: none"> <li>• Aerosol Head</li> <li>• Medication Cap and Seal</li> <li>• Blue Valve</li> <li>• Medication Reservoir and Aerosol Chamber</li> <li>• Mouthpiece</li> </ul>	Warm running tap water.	Until soap is removed.	Check each part and soak for another 5 minutes if any part looks dirty.
Disinfect	Prior to first use and after each use	<ul style="list-style-type: none"> <li>• Aerosol Head</li> <li>• Medication Cap and Seal</li> <li>• Blue Valve</li> <li>• Medication Reservoir and Aerosol Chamber</li> <li>• Mouthpiece</li> </ul>	Boil in <b>distilled</b> water.	5 minutes	Air-dry in a dust-free environment.

**WARNING** Your Handset including the Aerosol Head is not sterile. Contamination and moisture may cause the growth of bacteria and the Aerosol Head can be affected by ARIKAYCE left over in it. It is important to rinse, clean, and disinfect your Handset including the Aerosol Head before first use and right after every use. If your Handset or Aerosol Head looks dirty, soak the parts in soapy water for longer than 5 minutes. Do not place the Handset or the Aerosol Head in a dishwasher.

### Cleaning your Handset

Step F1: Disconnect your Handset from the Connection Cord (F-1).

F-1

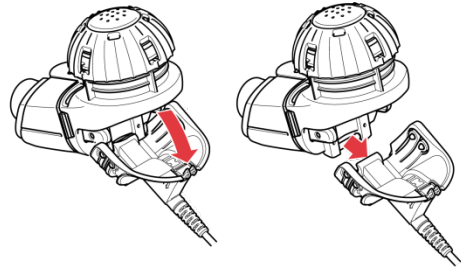

Step F2: Remove the Medication Cap by turning counterclockwise and pulling straight up (F-2).

F-2

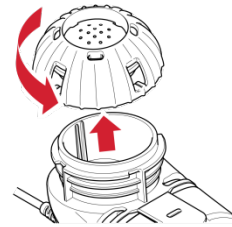

Step F3: Remove the Mouthpiece from the Aerosol Chamber by pulling straight off (F-3). The Blue Flap must still be attached to the mouthpiece as shown in the picture.

F-3

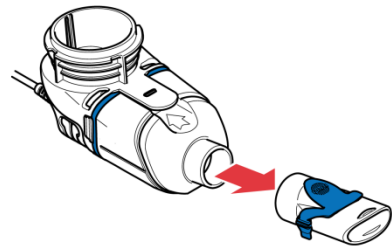



**Step F4:** Gently pull up on the tab to open the Handset and remove the Blue Valve (F-4).

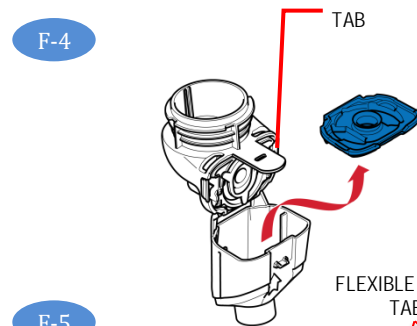

**Step F5:** Being careful to touch only the plastic outer ring of the Aerosol Head, press the 2 flexible plastic tabs on the side of the Aerosol Head towards each other and remove (F-5). After the Aerosol Head has been used 7 times, throw away (dispose of) and replace with a new one.

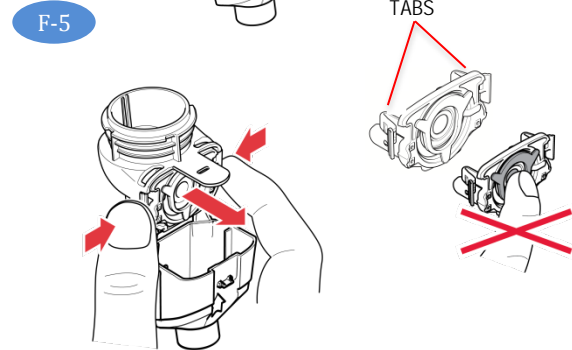

Do not touch the center silver part of the Aerosol Head.

**Step F6:** Gently wipe away any drops of medicine from the Medication Reservoir (F-6a), Aerosol Chamber (F-6b) and Mouthpiece (F-6c) before rinsing to reduce antibiotics added to water systems.

Use only plain, dry paper towels or wipes. Do not use towels or wipes that have any chemicals added to them such as alcohol, lotion, or baby wipes.

Be careful not to harm the parts.

Do not wipe the Aerosol Head.

Throw away paper towels by disposing in trash with solid waste.

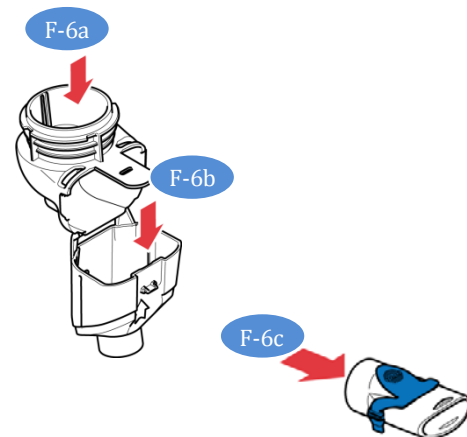

**Step F7:** Rinse each of the parts under warm running tap water for 10 seconds. Pay special attention to rinsing the Aerosol Head and rinse each side of the Aerosol Head for 10 seconds (F-7). Thorough rinsing of both sides of the Aerosol Head helps to prevent clogging and makes sure the Aerosol Head works properly. Never use a brush or any other object to clean the Aerosol Head.

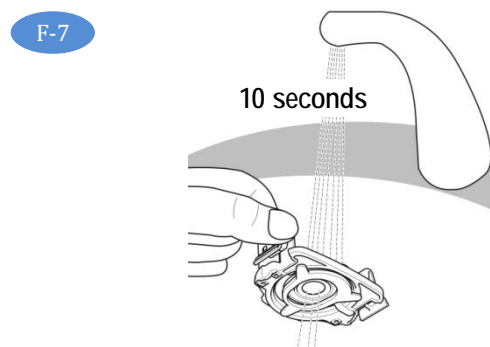

**F****Cleaning Your Lamira (continued)**

**Step F8:** Clean all Handset parts by adding a few drops of clear liquid dish soap and warm tap water to a clean tub or bowl. Cover the Handset parts in the warm soapy water and soak for 5 minutes, shaking them periodically (F-8).

F-8

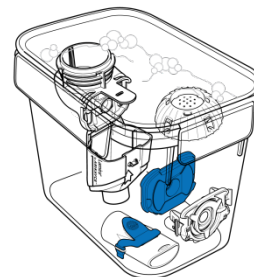

**Step F9:** Rinse all parts thoroughly under warm running tap water to remove soap (F-9). Check each part and soak for another 5 minutes if any of the parts look dirty. After all parts are cleaned and free from soap, disinfect your Handset.

F-9

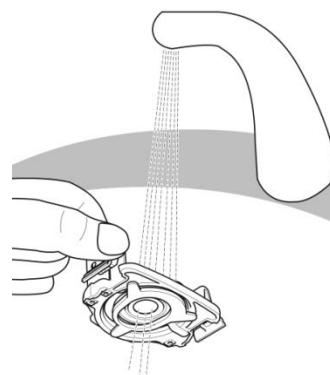

**Step F10:** Disinfect the Handset including the Aerosol Head after cleaning. In addition to cleaning ARIKAYCE from your Handset, you must also disinfect your Handset to remove bacteria and avoid infection. See Section G for instructions on how to disinfect your Lamira Handset.

**Cleaning your Controller and Connection Cord**

**Step F11:** To reduce the risk of electric shock, disconnect all connections before cleaning. Switch off the Controller. Remove the Connection Cord and A/C Power Supply cord from the Controller.

**Step F12:** Clean the Controller housing and Connection Cord as needed with a soft, clean, damp cloth. Do not place the Controller unit under water or allow liquid to get inside the Controller. Make sure moisture from the cloth does not enter the Controller.

**Caution** Never let the Controller come in contact with water or cleaning agents. If liquid does get into the Controller, contact the Arikares Support Program.

## G

# Disinfecting Your Lamira

**Warning** To prevent serious or fatal illness or injury caused by contamination, disinfect your Handset including the Aerosol Head at the end of every day.

**Step G1:** Clean your Handset right after every use with soapy water as described in Section F.

**Step G2:** Disinfect your Handset at the end of every day by boiling in distilled water.

To disinfect with boiling water, boil the Handset parts, including the Aerosol Head, in a clean pot of **distilled** water for a full 5 minutes.

**Step G3:** Air dry on a lint-free towel (G-3). After the parts are completely dry, wrap them in a lint-free towel for storage. Reassemble just before taking your next treatment. This is to make sure the Blue Valve will not become damaged.

G-3

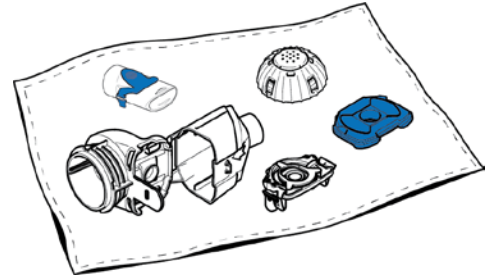

**Warning**

**Your Handset including the Aerosol Head is not sterile.**

Clean and disinfect your Handset before the first time you use it and after each use (See Sections F and G). Inspect all parts to make sure they are cleaned and are not visibly damaged. Do not use dirty or damaged parts.

**Step H1: Clean and Disinfect your Handset before the first time you use it.** See Sections F and G.

**Step H2: Wash your hands with soap and water and dry them well (H-2).**

**Step H3: Open the Handset.** The Medication Reservoir and the Aerosol Chamber are attached using a "hinge". First, gently pull up on the tab of the hinge (H-3). This will release the Medication Reservoir (H-3). This will release the Aerosol Chamber so that you may open it.

**Step H4: Insert the Blue Valve on top of the Aerosol Chamber (H-4).** Make sure the 2 valve flaps are positioned down as shown in H-4a. **Do not** push the Blue Valve inside of the Aerosol Chamber. The Blue Valve should be placed on top of the Aerosol Chamber.

Clean and disinfect your Handset before the first time you use it.

H-2

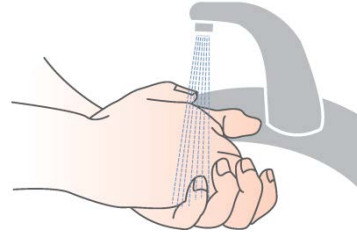

H-3

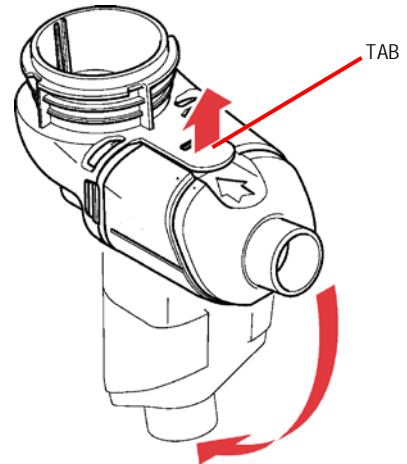

H-4

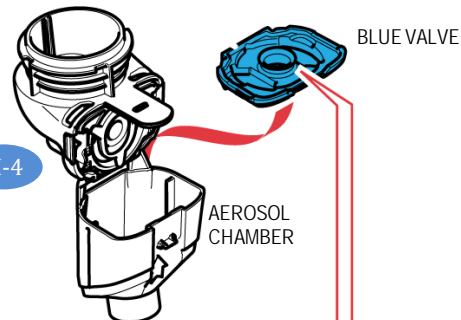

VALVE FLAPS

H-4a

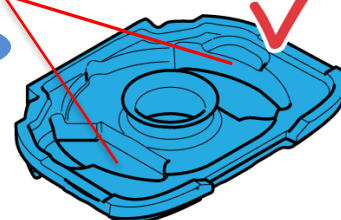

VALVE FLAP

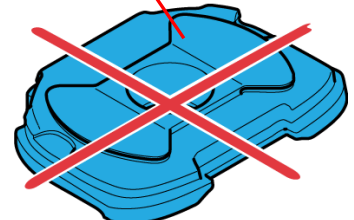

**Step H5: Insert the Aerosol Head**

Note: It is important that you do not touch the silver part of the Aerosol Head at any time during assembly. (H-5a)

H-5a

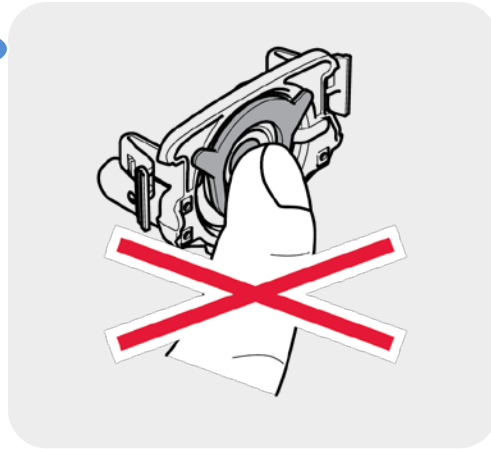

Check to make sure the Aerosol Head is labeled "For Amikacin Liposome Inhalation Suspension". Do not use other eFlow Technology Aerosol Heads in the Lamira. (H-5b).

H-5b

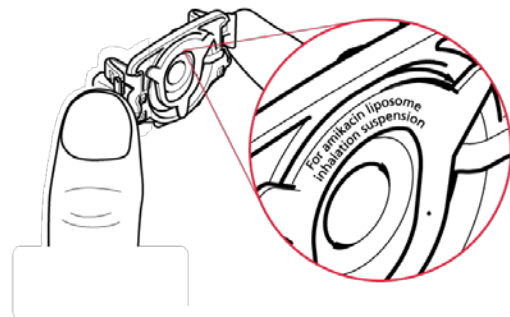

Carefully grasp the Aerosol Head by the 2 flexible plastic tabs on each side of the Aerosol Head. Turn the Aerosol Head so that "For Amikacin Liposome Inhalation Suspension" is facing toward you and is at the top of the Aerosol Head (H-5b).

H-5c

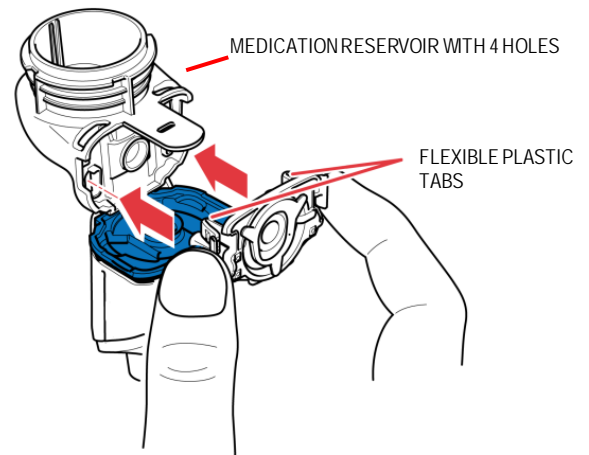

Squeeze the two flexible plastic tabs together while inserting the metal arms and flexible plastic tabs into the Medication Reservoir (H-5c). You should feel the flexible plastic tabs "grab" as you insert it.

H-6

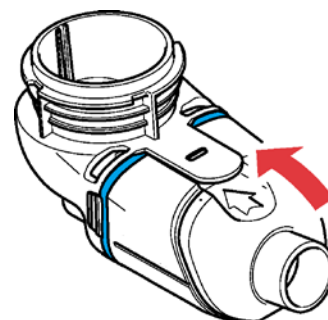

**Step H6: Close your Handset** by pushing the Aerosol Chamber together with the Medication Reservoir until you hear a "snap" (H-6). If you do not hear a snap, open the Handset and check that the Blue Valve is seated properly (See Step H-4).

**Step H7: Attach Mouthpiece to your Handset.** Make sure the Blue Flap is facing up (H-7) and is pressed in the slot on the Mouthpiece. Push the Mouthpiece straight onto the Handset. Make sure the Mouthpiece stays attached to the Handset during treatment.

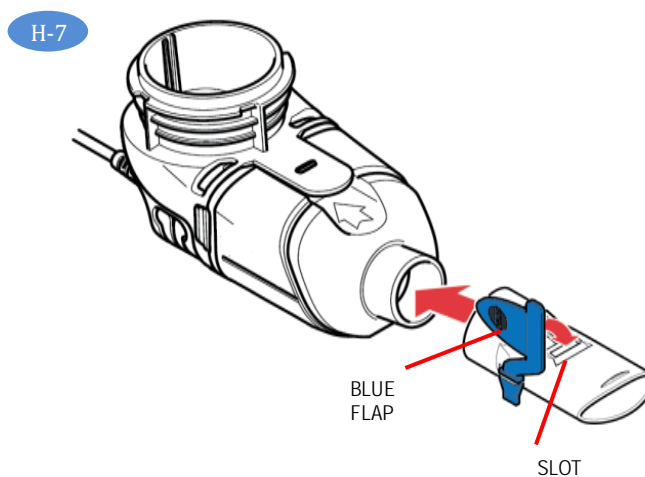

**Step H8: Attach the Connection Cord** by lining up the bottom of the Connector with the bottom of the Handset (H-8a) and pushing the Connection Cord upward against the rear underside of the Handset (H-8b) until you hear the parts snap together.

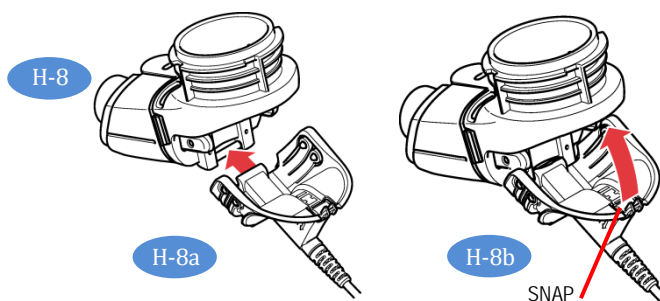

**Step H9: Connect the Connection Cord to the Controller.** Push the round end of the Connection Cord into the plug inlet port located under the digital display (H-9). Place the Controller with the attached Handset on a clean, flat, stable surface.

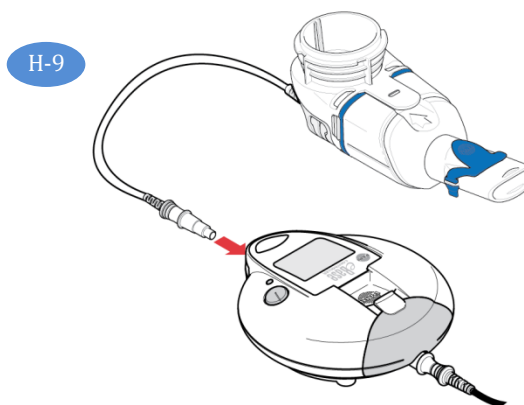

# I Taking ARIKAYCE

## Important information to know before you start

- If you use a **bronchodilator** (reliever), use the bronchodilator first, before using ARIKAYCE. Refer to your bronchodilator leaflet for information. The nebulizer for ARIKAYCE should only be used for giving ARIKAYCE.
- Each vial of ARIKAYCE is for **single (1 time) use only**.
- **Do not use** ARIKAYCE with any other type of Handset or Aerosol Head than the one provided in the carton.
- **Do not put** other medicines in the Lamira Nebulizer Handset.
- **Do not drink** the liquid in the vial.
- **Do not use** ARIKAYCE if the expiration date has passed.

## Getting your ARIKAYCE ready before adding it to the Lamira Nebulizer Handset.

**Step I1:** Shake the ARIKAYCE vial well for at least 10 to 15 seconds, until the medicine looks the same throughout and well mixed (I-1).

**Step I2:** Lift orange cap from vial and throw away (dispose of) the orange cap (I-2).

**Step I3:** Grip metal ring on top of the vial. Pull it down gently (I-3) until 1 side breaks away from the vial (I-3a).

**Step I4:** Pull the metal band from around the vial top in a circular motion until it comes off completely from the vial (I-4). Throw away (dispose of) the metal band after it is removed.

**Step I5:** Carefully remove the rubber stopper by pulling it upward (I-5).

**Step I6:** Make sure your Handset is placed on a clean, flat, stable surface. Pour 1 vial of ARIKAYCE into the Medication Reservoir (I-6). Do not use more than 1 vial for each treatment.

Your ARIKAYCE should be at room temperature before use to make sure that your Lamira operates properly. Bring ARIKAYCE to room temperature by removing it from the refrigerator at least 45 minutes before use. Do not use if your ARIKAYCE has been frozen.

Do not use other medicine in your handset.

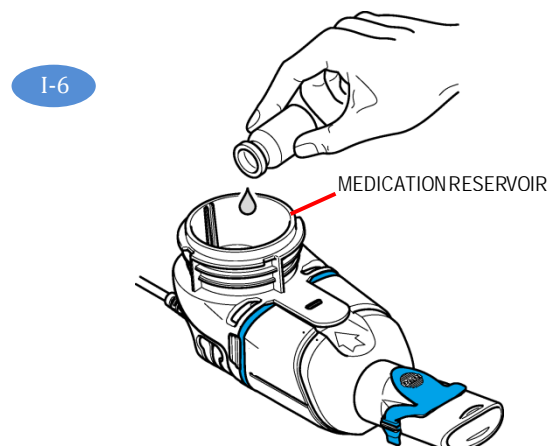
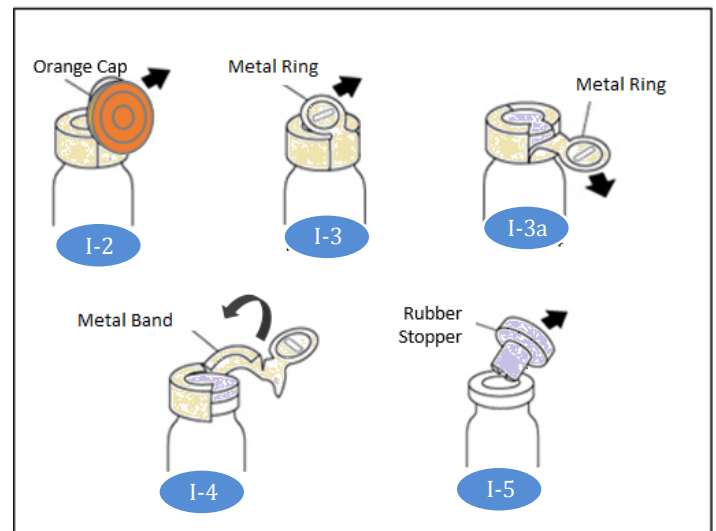

# I Taking ARIKAYCE (continued)

**Step 17:** Attach the Medication Cap by lining up the Tabs on the Medication Cap with the Tab Slots on the Medication Reservoir (I-7). Turn the Medication Cap clockwise until it stops. As the Medication Cap is turned, the inner cap of the Medication Cap should rise.

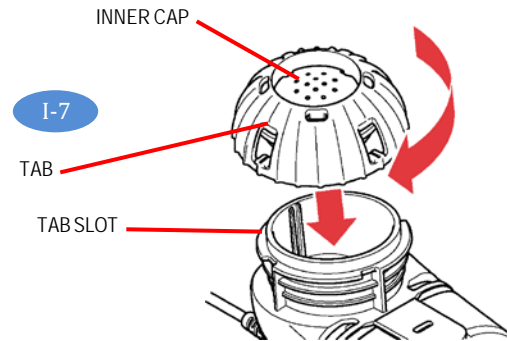

**Step 18:** To begin your treatment, sit in a relaxed, upright position. Press and hold the On/Off (2 to 3 seconds) (I-8) until the start screen appears on the LCD display (I-8a). You will also hear 1 “beep” and the status light will turn green. The Lamira is now On.

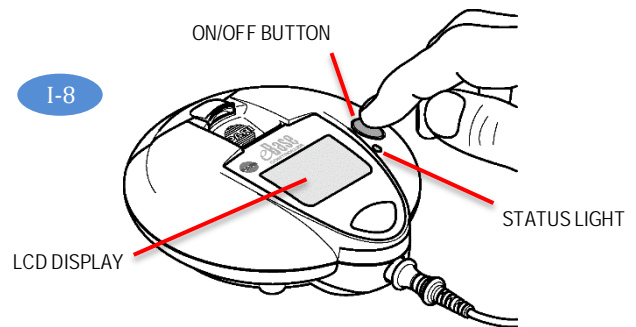

After treatment begins, the treatment screen (I-8b) will replace the start screen (I-8a) and aerosol mist will begin to flow.

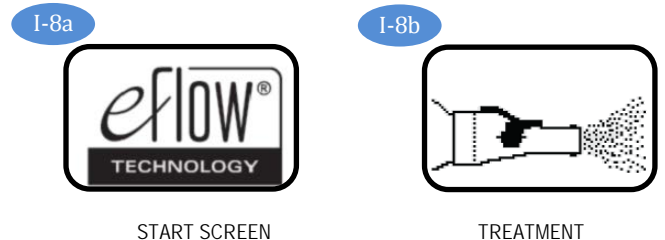

**Step 19:** Insert the Mouthpiece by placing it on top of your bottom lip and tongue. Close your lips around the Mouthpiece (I-9). Take slow, deep breaths then breathe normally in and out through the Mouthpiece until your treatment is complete. Your treatment should take about 14 minutes, but could take up to 20 minutes.

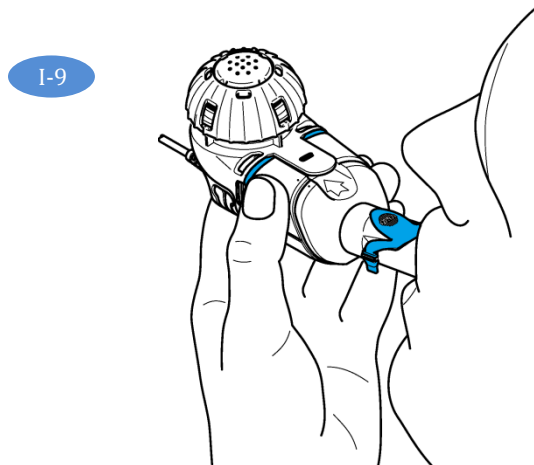



# I Taking ARIKAYCE (continued)

Hold the Handset level throughout your treatment. If the Handset is held at an angle over 45 degrees (I-9a), it will sound 2 beeps (and 2 green lights) and shut off after 30 seconds. If this occurs, hold the Handset level and press the On/Off Button to start your treatment again.

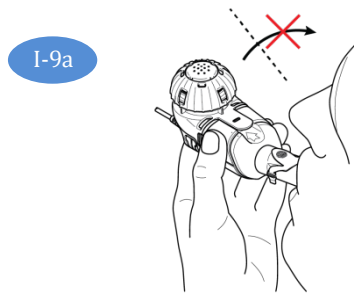

**Note:** The Lamira can be stopped at any time during operation by pressing the On/Off button for 3 seconds. The screen will go from On (I-9b) to Pause (I-9c), a 5-beep alarm tone will sound, and the status light on the Controller will flash Red-Green. To resume your treatment, press the Controller On/Off button for 1 full second. The Controller will run for up to 20 minutes. If your treatment is not complete after 20 minutes, press the On/Off button to continue treatment.

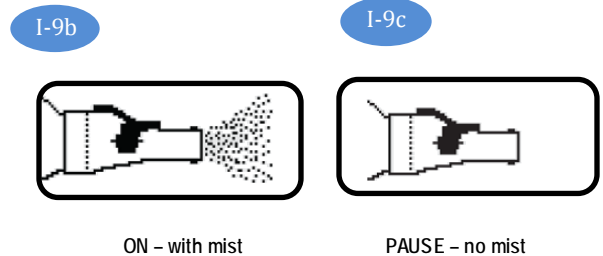

## Important Information:

The amount of time to nebulize your ARIKAYCE may change from dose to dose and may become longer unless the cleaning and maintenance instructions are followed (See Maintaining Your Lamira).

**Step I10:** At the end of your treatment, the following will happen:

- The Lamira will beep 2 times.
- The LED will flash red 2 times.
- The Dose Complete Checkmark will appear briefly on the screen (I-10a).
- The Controller will automatically shut off.

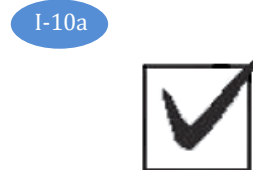

Always check the Medication Reservoir by removing the Medication Cap (I-10b) to make sure you have completed your dose. If more than a few drops of ARIKAYCE remains, replace the Medication Cap (I-10c) and press On/Off start button and complete your dose.

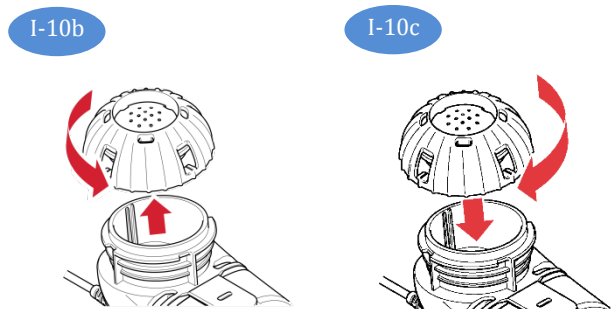

**Change your Aerosol Head after 7 uses.** After the Aerosol Head has been used 7 times, replace it with a new Aerosol Head during the cleaning process. Follow the instructions in Steps F6 through F9 and replace the Aerosol Head with a new one.

**Important:** Clean and disinfect your Handset after each use. See sections F and G for instructions.  
Change your Aerosol Head after 7 uses.

**QUESTION 1: How long should my ARIKAYCE treatment take?**

**Answer:** With normal operation and proper cleaning, your Handset should deliver 1 vial of ARIKAYCE in about 14 minutes but could take up to 20 minutes. Your Lamira should automatically shut off shortly after your treatment is complete or after 20 minutes. If the Lamira turns off after 20 minutes, check the Medication Reservoir. If it is empty, you have received your full dose.

**QUESTION 2: How much ARIKAYCE should be left in the Medication Reservoir at the end of my treatment?**

**Answer:** Only a drop of ARIKAYCE should remain in the Medication Reservoir. If more than a drop remains, start the Controller and complete your dose. Then clean the Aerosol Head (Section F). If after proper cleaning, more than a drop remains in the Medication Reservoir, contact the Arikares Support Program at 1-833-ARIKARE (1-833-274-5273).

**QUESTION 3: When I turn on my Nebulizer, nothing happens. There does not seem to be any power.**

**Answer:** If you are using batteries, use the figures in each Battery Compartment to check that the batteries are inserted correctly. If the batteries are positioned properly, check to see if the light is blinking on the Controller signaling low battery power. If it is, replace the batteries or use the A/C Power Supply.

**Answer:** If you are using the A/C Power Supply, check the connection to be sure it is firmly connected to the Power Supply Port located underneath the Battery Compartment. Be sure that the A/C Power Supply is plugged into a working wall outlet.

**QUESTION 4: Sometimes I have trouble removing the Medication Cap at the end of my therapy session.**

**Answer:** A vacuum has formed in the Medication Reservoir. Remove the Connection Cord, open the Handset and carefully remove the Aerosol Head. The Medication Cap will then be easier to remove.

**QUESTION 5: What if no mist is coming out of your Handset?**

**Answer:** First, check that the Controller has power. Secondly, make sure the Connection Cord is correctly attached. Thirdly, check to be sure that your Handset has been assembled properly (Section H). Lastly, check to be sure that the ARIKAYCE is in the Medication Reservoir. If the Controller or your Handset still do not function properly, contact the Arikares Support Program at 1-833-ARIKARE (1-833-274-5273).

**QUESTION 6: What if liquid is leaking from my Handset during my treatment?**

**Answer:** To prevent leaks, be sure (1) the Blue Valve is properly attached to the Aerosol Chamber, (2) the Aerosol Head is inserted correctly, (3) the Medication Cap is screwed on fully, and (4) the Medication Reservoir and Aerosol Chamber are closed properly and *snapped* together.

**Answer:** It is normal to have some liquid collect in the Aerosol Chamber. Try to hold the Handset so that liquid does not pour out of the Mouthpiece.

**QUESTION 7: What if my Controller shuts off before my treatment begins, or does not restart?**

**Answer:** Low voltage. Replace the batteries or use the AC adapter. Press the On/Off button to continue your treatment.

**Answer:** Your Handset was tilted above 45°. Hold your Handset level and press the On/Off button to continue your treatment.

**Answer:** ARIKAYCE is cold. Allow the ARIKAYCE to warm to room temperature and then press the On/Off button to continue your treatment.

**QUESTION 8: What if my Controller does not shut off at the end of my treatment?**

**Answer:** Your Controller may take up to 60 seconds to shut off after you complete your dose. If you wish to stop your Controller earlier, press the On/Off button.

**Answer:** Disconnect the A/C Power Supply from the Controller and remove the batteries. Then, reinsert the Batteries following the procedure in Section D.

**Answer:** If this situation continues 3 or 4 times, contact the Arikares Support Program at 1-833-ARIKARE (1-833-274-5273).











**QUESTION 9: How long will a new set of batteries last?**

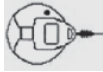

**Answer:** A new set of batteries should provide 2 hours of total use.

**Answer:** Consider using rechargeable batteries.

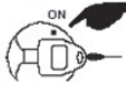
**QUESTION 10: What if something arrives damaged?**

**Answer:** Contact the Arikares Support Program at 1-833-ARIKARE (1-833-274-5273).

	Fault and Condition	Possible Cause and Solution
1	Steady 	Controller running on AC Power.
2	Steady 	Controller running on battery power.
3	Flashing 	Empty battery, replace batteries or switch to A/C power.
4	Flashing  The LED changed from green to red and the battery symbol is blinking during treatment	Low battery, replace batteries or switch to A/C power.
5	Flashing  Lamira turns on but LED flashes green-red and LCD display flashes this symbol	Bad or missing Connection Cord. Check Connection Cord between Handset and Controller. Bad or missing Aerosol Head. Correct then restart Controller.
6	Flashing  Lamira beeps 1x, then beeps high-low with the LED flashing and the LCD display flashing this symbol	No ARIKAYCE detected. Add ARIKAYCE. If you have already added ARIKAYCE, gently tap the Handset, hold the Handset level and restart the Controller.
7	Flashing  Lamira beeps low-high 3 times, the LED flashed green-red, the LCD displays this symbol, and then turns off	Have reached 20 minute maximum time and will shut down. If ARIKAYCE remains, restart the Controller. After treatment is complete, clean and disinfect the Handset including the Aerosol Head.
8	Steady  Lamira beeps 1 time and LCD shows this symbol	Misting and working properly.
9	Steady 	Controller has paused. To resume press On/Off button.
10	Flashing 	Press button to start treatment.
11	Brief 	Functioning properly, the Controller has started properly.

	Fault and Condition	Possible Cause and Solution
12	Brief  <p>The Lamira beeps 2 times, displays this checkmark symbol, then turns off.</p>	<p>No ARIKAYCE remaining, your treatment is done.</p> <p>If ARIKAYCE is remaining, your Handset might be tilted. Keep Handset level, gently tap Handset and restart Controller.</p>
13	<p>The Lamira cannot be activated and no green LED, no screen, and no beep.</p>	<p>Bad, missing or misloaded batteries.</p> <p>Bad or missing A/C Power Supply.</p>
14	<p>The Lamira beeps 1 time and begins to produce a mist, then stops and shuts off with no beep, no LED, and with ARIKAYCE still present.</p>	<p>Bad batteries or bad A/C Power Supply. Replace batteries or A/C Power Supply and restart Controller.</p>
15	<p>The Lamira stops before ARIKAYCE is completely used up.</p>	<p>Lost power. Replace batteries or use A/C Power Supply.</p> <p>Tilted Handset. Keep Handset level, gently tap Handset and restart Controller.</p>
16	<p>The Lamira does not stop automatically after all ARIKAYCE is consumed.</p>	<p>Clean and disinfect the Aerosol Head. If condition continues, contact the Arikares Support Program at 1-833-ARIKARE (1-833-274-5273).</p>
17	<p>Longer than normal nebulization time.</p>	<p>Aerosol Head is dirty. Clean and disinfect the Aerosol Head. Replace the Aerosol Head with a new one from your kit after 7 uses.</p>
18	<p>Handset leaks.</p>	<p>Make sure Blue Valve is placed correctly in the Handset and the 2 flaps point into the Handset Chamber (see Section H).</p> <p>Make sure Aerosol Head is correctly placed in the Handset.</p> <p>It is normal to have some liquid collect in the Aerosol Chamber and Mouthpiece. The amount depends on the volume of the ARIKAYCE and on your breathing pattern.</p>
19		<p>The On button was accidentally pressed for 10 seconds, which activated the easycare function. The easycare is an accessory that assists in cleaning the Aerosol Head but it is not used for your Lamira. Press the On button briefly to turn-off the Controller and stop the easycare function.</p>



# Specifications

## Mechanical

Weight: Controller and Handset.....	approx. 8.2 oz.
Weight: Controller, Handset, and Batteries.....	approx. 11 oz.
Handset Dimensions (W x H x D).....	2.0" X 2.4" X 5.5"
Controller Dimensions (H x Ø) .....	1.6" X 4.6"
Minimum Fill Volume .....	0.5 mL
Maximum Fill Volume .....	8.4 mL

## Electrical

Electrical Requirements .....	110 V - 240 V, 50 Hz/60 Hz
Power Wattage .....	2.0 Watts under normal load

## Transport and Storage

Temperature.....	-13° to 158° F
Relative Humidity (non-condensing) .....	0% to 93%
Air Pressure .....	9 to 15 PSI

## Operational

Temperature.....	41° to 104° F
Relative Humidity (non-condensing) .....	15% to 93%
Air Pressure .....	10 to 15 PSI

## Device Classification According to IEC 60601-1

Type of electric shock protection (AC power adapter).....	Protection Class II
Degree of protection from electric shock of part used (nebulizer) .....	Type BF
Degree of protection against water ingress per IEC 60529 IP rating (nebulizer).....	IP 21
Degree of protection when in the presence of flammable mixtures.....	No protection
Continuous operation.....	Operating mode

## Device Performance Characteristics

	Mean	Range <sup>a</sup>
Total Delivered Dose by Breath Simulation <sup>b</sup> (mg)	312.1	273.8 – 350.4
Total Delivered Dose by Breath Simulation (% of label claim <sup>c</sup> )	52.9	46.4 – 59.4
MMAD <sup>d</sup> by NGI <sup>e</sup> (µm)	4.45	4.38 – 4.52
GSD <sup>f</sup>	1.59	1.59 – 1.60
Respiratory Dose by NGI (≤ 5µm, mg)	327.1	316.5 – 337.6
Respiratory Fraction by NGI (≤5µm, % of delivered dose)	55.6	53.8 – 57.4

<sup>a</sup> Range - two-sided tolerance interval, proportion of total population=0.95  
<sup>b</sup> Breath simulation - tidal volume of 500 mL, 15 breath per minutes, and inhalation:exhalation ratio is 50:50  
<sup>c</sup> label claim - 590 mg  
<sup>d</sup> MMAD - Mass Median Aerodynamic Diameter  
<sup>e</sup> NGI - Next Generation Impactor  
<sup>f</sup> GSD - Geometric Standard Deviation

## Handset materials

Polypropylene, polyamide, silicone, stainless steel, thermoplastic elastomers. Does not contain any natural rubber (latex).

## Disposal

The Lamira components and batteries must be disposed of in accordance with local (state, county or municipal) regulations.

## Manufactured by:

PARI Respiratory Equipment, Inc.  
2412 PARI Way  
Midlothian, Virginia 23112 USA  
For patent information: [www.PARI.com/ip](http://www.PARI.com/ip)

©2018 PARI Pharma GmbH. All rights reserved. The PARI logo is a registered trademark of PARI GmbH. Altera®, eRapid®, and eFlow® logo are registered trademarks of PARI Pharma GmbH. Lamira™ is a trademark of PARI Pharma GmbH. ARIKAYCE is a registered trademark of Insmed Incorporated. Touchspray® made under license from the Technology Partnership.

**This Instructions for Use has been approved by the U.S. Food and Drug Administration**

678D0204 Rev20 9/18

## A. Getting Started

Store your ARIKAYCE medicine refrigerated until expiration date on vial. Do not freeze.

### 1 Gather your ARIKAYCE medicine. The ARIKAYCE 28-day kit contains:

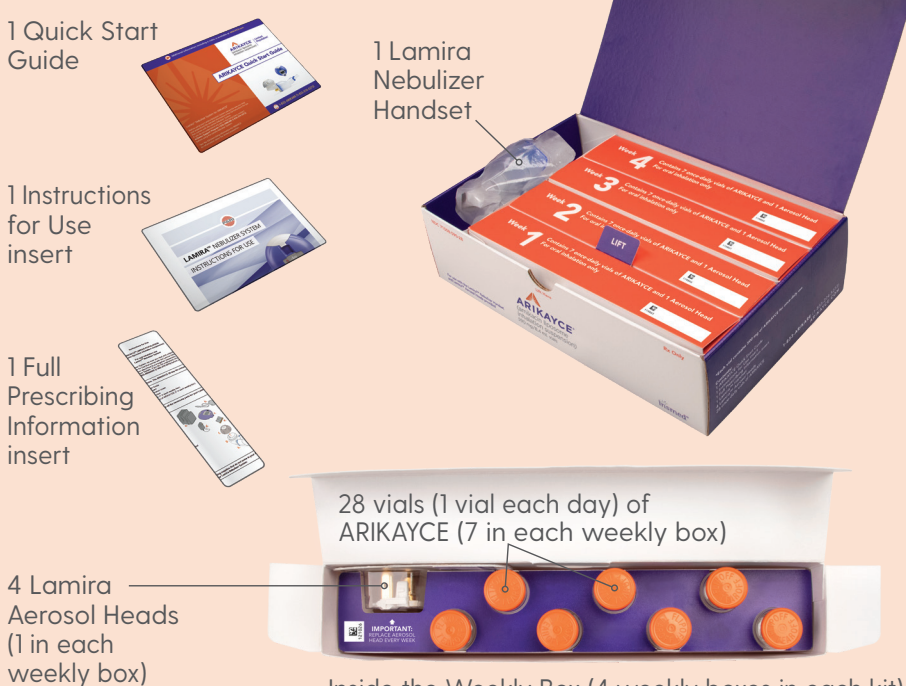

### 2 Check to make sure you have all the necessary parts for your Lamira™ Nebulizer System.

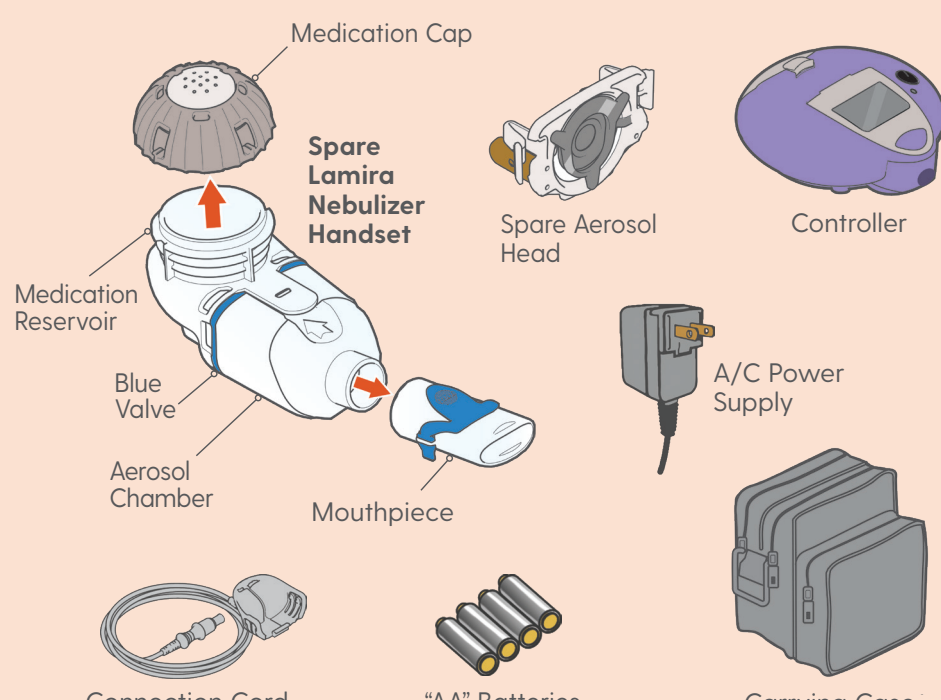

### 3 You will also need the following supplies:

- Clear liquid soap for cleaning the Handset and Aerosol Head
- Distilled water for disinfecting the Handset and Aerosol Head

### 4 Choose your power supply and get it ready.

- 4 "AA" batteries or
- A/C Power Supply

- Plug the A/C Power Supply into the Controller.
- Plug the A/C Power Supply into the wall outlet.

Do not insert the A/C Power into the front of the Controller.

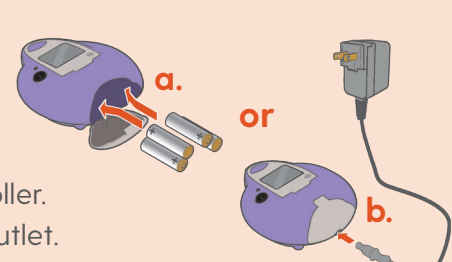

## B. Cleaning and Disinfecting Your Handset and Aerosol Head Before First Use

**Clean and disinfect your Handset and Aerosol Head before you use it for the first time.**

When you receive your Handset and Aerosol Head, they will not be sterile. Cleaning and disinfecting your Handset and Aerosol Head is important to reduce the risk of infection, illness, and contamination.

### 1 Cleaning the Handset and Aerosol Head Before First Use

**Reminder:** Clean the Handset and Aerosol Head before first use.

- Take apart (disassemble) the Handset for cleaning.
- Rinse each of the parts under warm running tap water for **10 seconds**. Rinse the Aerosol Head for **10 seconds on each side**.
- Clean all Handset parts by adding a few drops of clear liquid dish soap and warm tap water to a clean tub or bowl. Cover the Handset parts in the warm soapy water and soak for **5 minutes**, shaking them periodically. Then rinse them thoroughly under warm running tap water.

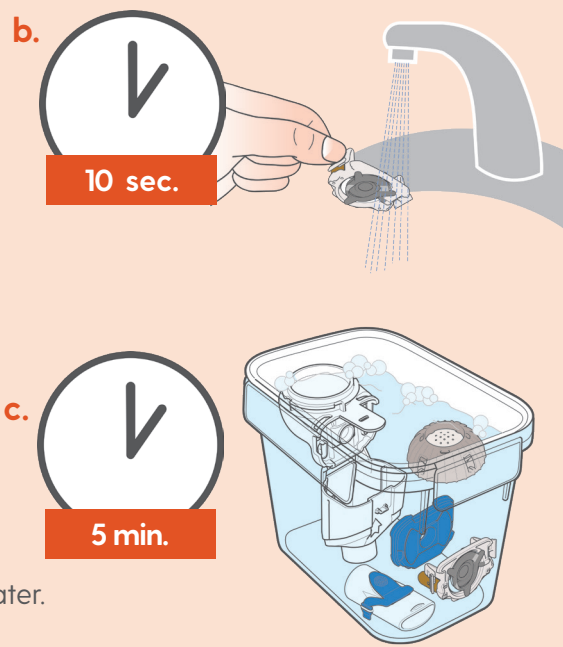

### 2 Disinfecting the Handset and Aerosol Head Before First Use

**Reminder:** Disinfect the Handset and Aerosol Head before first use.

- Be sure your Handset and Aerosol Head are clean before you disinfect.
- Boil the Handset parts, including the Aerosol Head, in a clean pot of **distilled water** for a full **5 minutes**.
- Air dry on a **lint-free towel**. When fully dry, wrap up the parts in a lint-free towel for storage. You can put them together again just before taking your next treatment.



## C. Assembling Your Handset

### 1 Wash your hands with soap and water, and dry them well.

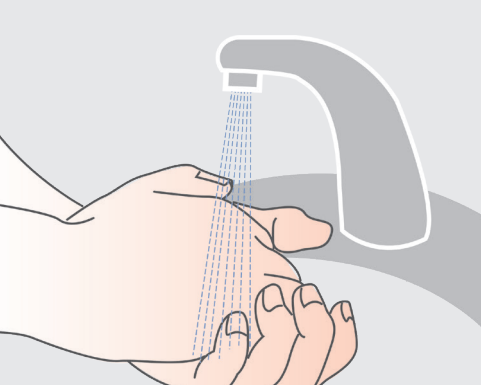

### 2 Insert the Blue Valve.

- Open the Handset by gently pulling up on the tab of the Medication Reservoir.
- Insert the Blue Valve so that it rests on top of the Aerosol Chamber with the 2 valve flaps facing down.

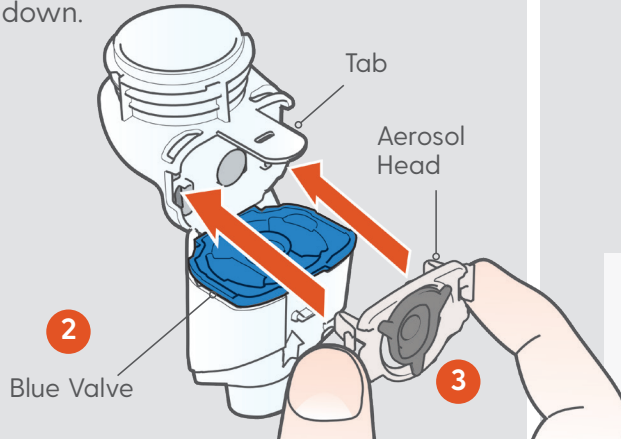

### 3 Insert the Aerosol Head.

- Grasp the Aerosol Head by the 2 flexible plastic tabs on each side. Be sure the text is facing toward you and is at the top of the Aerosol Head.
- Squeeze the 2 flexible plastic tabs together while inserting the Aerosol Head into the Medication Reservoir.
- Close the Handset when you are done.

Do not touch the silver part of the Aerosol Head at any time.

After the Aerosol Head has been used 7 times, throw away (dispose of) and replace with a new one during the cleaning process.

### 4 Attach the Mouthpiece to your Handset with the Blue Flap facing up.

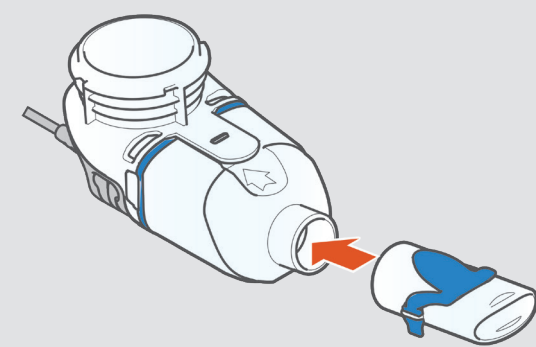

### 5 Finally, attach the Handset to the Controller.

- Attach the Connection Cord to the Handset.
  - Line up the bottom of the Connector with the bottom of the Handset.
  - Push upward against the Handset until you hear the pieces snap together.
- Connect the Connection Cord to the Controller.

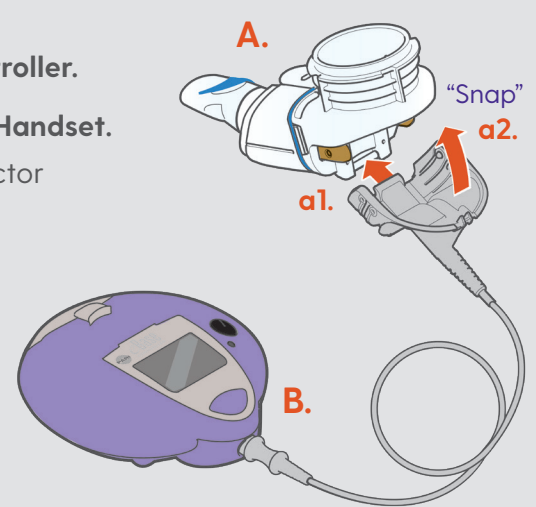

## D. Taking ARIKAYCE

Your ARIKAYCE should be at room temperature before use to make sure that your Lamira Nebulizer System operates properly. Do not use other medicines in your Handset. Bring ARIKAYCE to room temperature by removing it from the refrigerator at least 45 minutes before use. Do not use if your ARIKAYCE has been frozen.

### 1 Get your ARIKAYCE ready.

- Place the Handset on a clean, flat, stable surface.
- Shake the ARIKAYCE vial well for **at least 10 to 15 seconds**, until the medicine looks the same throughout and well mixed.

a. Open the vial and pour the ARIKAYCE into the Medication Reservoir. See instructions for how to open the ARIKAYCE vial on the right ▶

b. Attach the Medication Cap.



### How to open the ARIKAYCE vial

- Lift the orange cap from the vial.
- Grip the metal ring on top of the vial and pull it down gently until 1 side breaks away from the vial.
- Pull the metal band from around the vial top in a circular motion until it comes off completely.
- Carefully remove the rubber stopper.

### 2 Sit in a relaxed, upright position.

- Press and hold down on the On/Off button for a few seconds to turn the Lamira™ on.
- Mist will begin to flow.

### 3 Insert the Mouthpiece and take slow, deep breaths.

- Then, breathe normally in and out through the Mouthpiece until your treatment is complete.
- Treatment should take about 14 minutes but could take up to 20 minutes.

Be sure to hold the Handset level throughout the treatment.



### 4 Check that your treatment has ended.

- The Lamira Nebulizer System will beep 2 times.
- The LED light will flash red 2 times.
- A Checkmark will briefly appear on the screen.
- The Controller will automatically shut off.
- Remove the Medication Cap and check the Medication Reservoir to make sure that no more than a few drops of ARIKAYCE remains. If ARIKAYCE remains, replace the Medication Cap, press the On/Off button, and complete your dose.

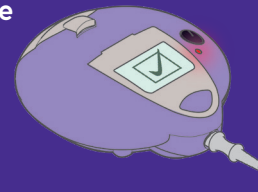

## E. Cleaning Your Lamira Handset and Aerosol Head After Use

Cleaning and disinfecting your Handset and Aerosol Head is important to reduce the risk of infection, illness, and contamination.

Immediately after each use, the Handset and Aerosol Head should be rinsed, cleaned, and disinfecting.

### 1 Cleaning the Handset and Aerosol Head

**Reminder:** Clean the Handset and Aerosol Head immediately after each use.

- Disconnect your Handset from the Connection Cord, then take apart (disassemble) the Handset for cleaning.
- Gently wipe away any drops of medicine from the Medication Reservoir, Aerosol Chamber, and Mouthpiece before rinsing, to reduce antibiotics added to water systems. Use only plain, dry paper towels or wipes. Do not use towels or wipes that have any chemicals added to them such as alcohol, lotion, or baby wipes. Be careful not to harm the parts. Do not wipe Aerosol Head. Throw away paper towels by disposing in trash with solid waste.

c. Rinse each of the parts under warm running tap water for **10 seconds**. Rinse the Aerosol Head for **10 seconds on each side**.

d. Clean all Handset parts by adding a few drops of clear liquid dish soap and warm tap water to a clean tub or bowl. Cover the Handset parts in the warm soapy water and soak for **5 minutes**, shaking them periodically. Then rinse them thoroughly under warm running tap water.

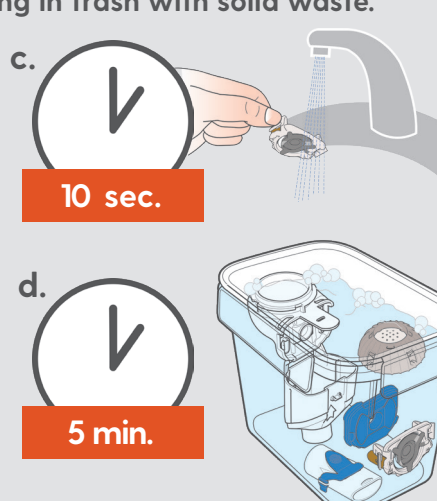

### 2 Disinfecting the Handset and Aerosol Head

**Reminder:** Disinfect the Handset and Aerosol Head every day.

- Be sure your Handset and Aerosol Head are clean before you disinfect.
- Boil the Handset parts, including the Aerosol Head, in a clean pot of **distilled water** for a full **5 minutes**.
- Air dry on a **lint-free towel**. When fully dry, wrap up the parts in a lint-free towel for storage. You can put them together again just before taking your next treatment.

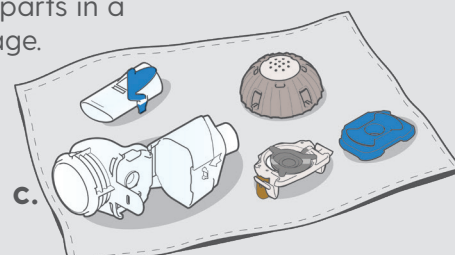

### 3 Cleaning Your Controller and Connection Cord

- To reduce the risk of infection, disconnect all connections before cleaning.
- Clean the Controller housing and Connection Cord as needed with a soft, clean, damp cloth. Do not place the Controller unit under water. Do not allow liquid or moisture to get inside the Controller.

See the full prescribing information for ARIKAYCE for information about the limited population.  
Before using your Lamira Nebulizer System, please be sure you read and understand the detailed information in the full instructions for use that comes with the Lamira Nebulizer System.  
If you do not understand any part of the instructions, contact Arikayes Support Program 1-833-ARIKARE (1-833-274-5273) before using the Lamira Nebulizer System.

Lamira™ Nebulizer System for ARIKAYCE®

Before using your Lamira Nebulizer System, please be sure you read and understand the detailed information in the full instructions for use that comes with the Lamira Nebulizer System.

If you do not understand any part of the instructions, contact Arikayes Support Program 1-833-ARIKARE (1-833-274-5273)

before using the Lamira Nebulizer System.

See the full prescribing information for ARIKAYCE for information about the limited population.



# ARIKAYCE Quick Start Guide



Additional information, including a video, is available at [ARIKAYCE.com](https://www.ARIKAYCE.com)

© 2018 Inmed Incorporated. All Rights Reserved. Inmed and ARIKAYCE are trademarks of Inmed Incorporated. All other trademarks referenced herein are the property of their respective owners.

Lamira Nebulizer System manufactured by:  
PARI Respiratory Equipment, Inc.  
2412 PARI Way  
Midlothian, VA 23112

MFG-OPS-00202  
9/18

-----  
**This is a representation of an electronic record that was signed electronically. Following this are manifestations of any and all electronic signatures for this electronic record.**  
-----

/s/  
-----

SUMATHI NAMBIAR  
10/19/2020 07:30:15 PM