

HIGHLIGHTS OF PRESCRIBING INFORMATION

These highlights do not include all the information needed to use SKYLA safely and effectively. See full prescribing information for SKYLA.

SKYLA (levonorgestrel-releasing intrauterine system)

Initial U.S. Approval: 2000

RECENT MAJOR CHANGES

Dosage and Administration (2.2)	7/2021
Warnings and Precautions (5.2)	5/2021
Warnings and Precautions (5.5, 5.6)	7/2021

INDICATIONS AND USAGE

Skyla is a progestin-containing intrauterine system (IUS) indicated for prevention of pregnancy for up to 3 years. (1)

DOSAGE AND ADMINISTRATION

- Release rate of levonorgestrel (LNG) is 14 mcg/day after 24 days and declines to 5 mcg/day after 3 years; Skyla must be removed or replaced after 3 years. (2.1)
- To be inserted by a trained healthcare provider using strict aseptic technique. Follow insertion instructions exactly as described. (2.2)
- Patient should be re-examined and evaluated 4 to 6 weeks after insertion; then, yearly or more often if clinically indicated. (2.3)

DOSAGE FORMS AND STRENGTHS

- One sterile intrauterine system consisting of a T-shaped polyethylene frame with a steroid reservoir containing 13.5 mg levonorgestrel packaged within a sterile inserter (3)

CONTRAINDICATIONS

- Pregnancy or suspicion of pregnancy. Cannot be used for post-coital contraception (emergency contraception) (4)
- Congenital or acquired uterine anomaly if it distorts the uterine cavity (4)
- Acute pelvic inflammatory disease (PID) or a history of PID unless there has been a subsequent intrauterine pregnancy (4)
- Postpartum endometritis or infected abortion in the past 3 months (4)
- Known or suspected uterine or cervical malignancy (4)
- Known or suspected breast cancer or other progestin-sensitive cancer (4)
- Uterine bleeding of unknown etiology (4)

- Untreated acute cervicitis or vaginitis or other lower genital tract infections (4)
- Acute liver disease or liver tumor (benign or malignant) (4)
- Increased susceptibility to pelvic infection (4)
- A previous intrauterine device (IUD) that has not been removed (4)
- Hypersensitivity to any component of Skyla (4)

WARNINGS AND PRECAUTIONS

- Remove Skyla if pregnancy occurs with Skyla in place. If a pregnancy occurs, there is increased risk of ectopic pregnancy including loss of fertility, pregnancy loss, septic abortion (including septicemia, shock and death), and premature labor and delivery. (5.1, 5.2)
- Group A streptococcal infection has been reported following insertion of LNG IUS; strict aseptic technique is essential during insertion. (5.3)
- Before using Skyla, consider the risks of PID. (5.4)
- Uterine perforation may occur and may reduce contraceptive effectiveness or require surgery. Risk is increased if inserted in lactating women and may be increased if inserted in women with fixed retroverted uteri and postpartum. (5.5)
- Partial or complete expulsion may occur, which can be unnoticed, leading to loss of contraceptive efficacy. (5.6)
- Evaluate persistent enlarged ovarian follicles or ovarian cysts. (5.7)
- Bleeding patterns become altered, may remain irregular and amenorrhea may ensue. (5.8)
- Skyla can be safely scanned with MRI only under certain conditions (5.11)

ADVERSE REACTIONS

The most common adverse reactions reported (>10% users) are bleeding pattern alterations, vulvovaginitis, abdominal/pelvic pain, acne/seborrhea, headache/migraine, ovarian cyst and dysmenorrhea/uterine spasm. (6)

To report SUSPECTED ADVERSE REACTIONS, contact Bayer HealthCare Pharmaceuticals Inc. at 1-888-842-2937 or FDA at 1-800-FDA-1088 or www.fda.gov/medwatch

See 17 for PATIENT COUNSELING INFORMATION and FDA-approved patient labeling

Revised: 7/2021

FULL PRESCRIBING INFORMATION: CONTENTS*

1 INDICATIONS AND USAGE

2 DOSAGE AND ADMINISTRATION

- Dosing Over Time
- Insertion Instructions
- Patient Follow-up
- Removal of Skyla
- Continuation of Contraception after Removal

3 DOSAGE FORMS AND STRENGTHS

4 CONTRAINDICATIONS

5 WARNINGS AND PRECAUTIONS

- Risk of Ectopic Pregnancy
- Risks with Intrauterine Pregnancy
- Sepsis
- Pelvic Infection
- Perforation
- Expulsion
- Ovarian Cysts
- Bleeding Pattern Alterations
- Breast Cancer
- Clinical Considerations for Use and Removal
- Magnetic Resonance Imaging (MRI) Information

6 ADVERSE REACTIONS

- Clinical Trials Experience
- Postmarketing Experience

7 DRUG INTERACTIONS

8 USE IN SPECIFIC POPULATIONS

- Pregnancy
- Lactation
- Females and Males of Reproductive Potential
- Pediatric Use
- Geriatric Use

11 DESCRIPTION

- Skyla
- Inserter

12 CLINICAL PHARMACOLOGY

- Mechanism of Action
- Pharmacodynamics
- Pharmacokinetics

13 NONCLINICAL TOXICOLOGY

- Carcinogenesis, Mutagenesis, Impairment of Fertility

14 CLINICAL STUDIES

15 REFERENCES

16 HOW SUPPLIED/STORAGE AND HANDLING

17 PATIENT COUNSELING INFORMATION

*Sections or subsections omitted from the full prescribing information are not listed.

FULL PRESCRIBING INFORMATION

1 INDICATIONS AND USAGE

Skyla[®] is indicated to prevent pregnancy for up to 3 years. Replace the system after 3 years if continued use is desired.

2 DOSAGE AND ADMINISTRATION

2.1 Dosing Over Time

Skyla contains 13.5 mg of levonorgestrel (LNG) released *in vivo* at a rate of approximately 14 mcg/day after 24 days. This rate decreases progressively to approximately 6 mcg/day after 1 year and to 5 mcg/day after 3 years. The average *in vivo* release rate of LNG is approximately 8 mcg/day over the first year of use and 6 mcg/day over a period of 3 years. [See *Clinical Pharmacology* ([12.3](#)).]

Skyla must be removed by the end of the third year and can be replaced at the time of removal with a new Skyla if continued contraceptive protection is desired.

Skyla can be physically distinguished from other intrauterine systems (IUSs) by the combination of the visibility of the silver ring on ultrasound and the brown color of the removal threads.

Skyla is supplied in a sterile package within an inserter that enables single-handed loading (see Figure 1). Do not open the package until required for insertion [see *Description* ([11.2](#))]. Do not use if the seal of the sterile package is broken or appears compromised. Use strict aseptic techniques throughout the insertion procedure [see *Warnings and Precautions* ([5.3](#))].

Skyla and Inserter

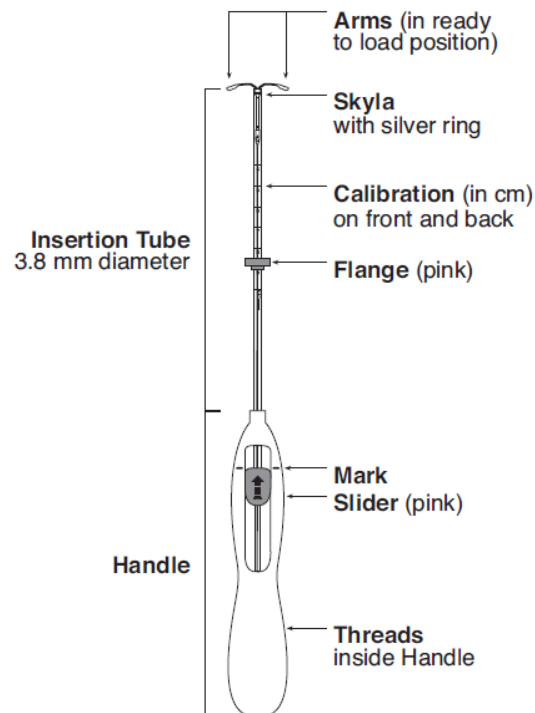

2.2 Insertion Instructions

- Obtain a complete medical and social history to determine conditions that might influence the selection of a levonorgestrel-releasing intrauterine system (LNG IUS) for contraception. If indicated, perform a physical

examination, and appropriate tests for any forms of genital or other sexually transmitted infections. [See *Contraindications (4) and Warnings and Precautions (5.10).*] Because irregular bleeding/spotting is common during the first months of Skyla use, exclude endometrial pathology (polyps or cancer) prior to the insertion of Skyla in women with persistent or uncharacteristic bleeding [see *Warnings and Precautions (5.8)*].

- Follow the insertion instructions exactly as described to ensure proper placement and avoid premature release of Skyla from the inserter. Once released, Skyla cannot be re-loaded.
- Check expiration date of Skyla prior to initiating insertion.
- Skyla should be inserted by a trained healthcare provider. Healthcare providers should become thoroughly familiar with the insertion instructions before attempting insertion of Skyla.
- Insertion may be associated with some pain and/or bleeding or vasovagal reactions (for example, syncope, bradycardia) or with seizure, especially in patients with a predisposition to these conditions. Consider administering analgesics prior to insertion.

Timing of Insertion

Table 1: When to Insert Skyla

Starting Skyla in women not currently using hormonal or intrauterine contraception	<ul style="list-style-type: none"> • Insert Skyla any time there is reasonable certainty that the woman is not pregnant. Consider the possibility of ovulation and conception prior to initiation of this product [see <i>Contraindications (4)</i>]. • If Skyla is inserted during the first seven days of the menstrual cycle or immediately after a first trimester abortion, back-up contraception is not needed. • If Skyla is not inserted during the first seven days of the menstrual cycle, a barrier method of contraception should be used, or the patient should abstain from vaginal intercourse for seven days to prevent pregnancy.
Switching to Skyla from an oral, transdermal or vaginal hormonal contraceptive	<ul style="list-style-type: none"> • Insert Skyla at any time, including during the hormone-free interval of the previous method. • If inserted during active use of the previous method, continue that method for 7 days after Skyla insertion or until the end of the current treatment cycle. • If the woman was using continuous hormonal contraception, discontinue that method seven days after Skyla insertion.
Switching to Skyla from an injectable progestin contraceptive	<ul style="list-style-type: none"> • Insert Skyla at any time; a non-hormonal back-up birth control (such as condoms or spermicide) should also be used for 7 days if Skyla is inserted more than 3 months (13 weeks) after the last injection.
Switching to Skyla from a contraceptive implant or another IUS	<ul style="list-style-type: none"> • Insert Skyla on the same day the implant or IUS is removed. • Insert Skyla at any time during the menstrual cycle.
Inserting Skyla after first-trimester abortion or miscarriage	<ul style="list-style-type: none"> • Insert Skyla immediately after a first-trimester abortion or miscarriage, unless it is a septic abortion [see <i>Contraindications (4)</i>].
Inserting Skyla after childbirth or second-trimester abortion or miscarriage	
Immediate insertion after childbirth or second-trimester abortion or miscarriage	<ul style="list-style-type: none"> • Insert Skyla after removal of the placenta. Back-up contraception is not needed. [See <i>Contraindications (4)</i>, <i>Warnings and Precautions (5.5, 5.6)</i>, <i>Adverse Reactions (6.2)</i>].

Interval insertion following complete involution of the uterus	<ul style="list-style-type: none"> • Wait a minimum of 6 weeks or until the uterus is fully involuted before inserting Skyla [see <i>Warnings and Precautions</i> (5.5, 5.6), <i>Adverse Reactions</i> (6.2)]. • Insert Skyla any time there is reasonable certainty the woman is not pregnant. • If Skyla is not inserted during the first 7 days of the menstrual cycle, a back-up method of contraception should be used, or the woman should abstain from vaginal intercourse for 7 days to prevent pregnancy [see <i>Contraindications</i> (4), <i>Warnings and Precautions</i> (5.2)].
--	---

Tools for Insertion

Note: The inserter provided with Skyla (see Figure 1) and the Insertion Procedure described in this section are not applicable for immediate insertion after childbirth or second-trimester abortion or miscarriage. For immediate insertion, remove Skyla from the inserter by first loading (see Figure 2) and then releasing (see Figure 7) Skyla from the inserter, and insert according to accepted practice.

Preparation

- Gloves
- Speculum
- Sterile uterine sound
- Sterile tenaculum
- Antiseptic solution, applicator

Procedure

- Sterile gloves
- Skyla with inserter in sealed package
- Instruments and anesthesia for paracervical block, if anticipated
- Consider having an unopened back-up Skyla available
- Sterile, sharp curved scissors

Preparation for insertion

- Exclude pregnancy and confirm that there are no other contraindications to the use of Skyla.
- With the patient comfortably in lithotomy position, do a bimanual exam to establish the size, shape and position of the uterus.
- Gently insert a speculum to visualize the cervix.
- Thoroughly cleanse the cervix and vagina with a suitable antiseptic solution.
- Prepare to sound the uterine cavity. Grasp the upper lip of the cervix with a tenaculum forceps and gently apply traction to stabilize and align the cervical canal with the uterine cavity. Perform a paracervical block if needed. If the uterus is retroverted, it may be more appropriate to grasp the lower lip of the cervix. The tenaculum should remain in position and gentle traction on the cervix should be maintained throughout the insertion procedure.
- Gently insert a uterine sound to check the patency of the cervix, measure the depth of the uterine cavity in centimeters, confirm cavity direction, and detect the presence of any uterine anomaly. If you encounter difficulty or cervical stenosis, use dilatation, and not force, to overcome resistance. If cervical dilatation is required, consider using a paracervical block.

Insertion Procedure

Proceed with insertion only after completing the above steps and ascertaining that the patient is appropriate for Skyla. Ensure use of aseptic technique throughout the entire procedure.

Step 1–Opening of the package

- Open the package (Figure 1). The contents of the package are sterile.

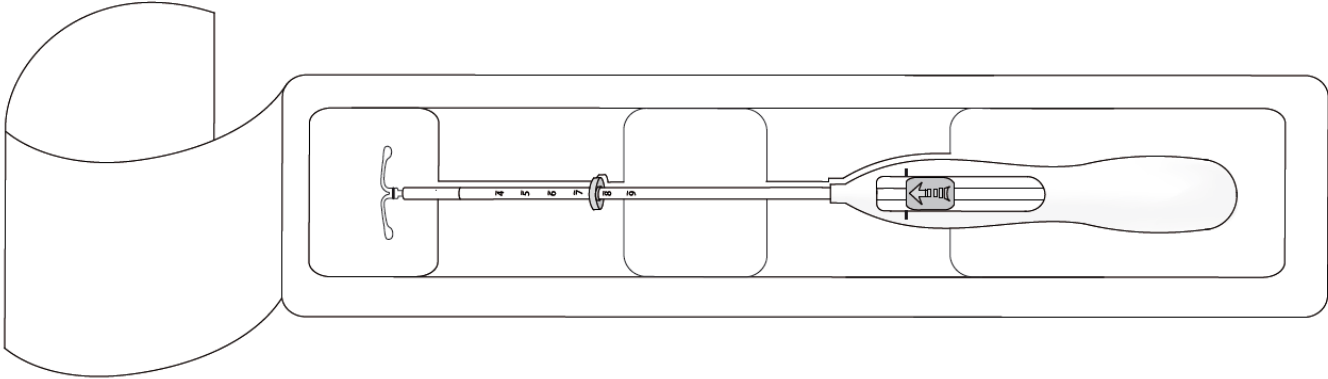

Figure 1. Opening the Skyla Package

- Using sterile gloves, lift the handle of the sterile inserter and remove from the sterile package.

Step 2–Load Skyla into the insertion tube

- Push the slider forward as far as possible in the direction of the arrow, thereby moving the insertion tube over the Skyla T-body to load Skyla into the insertion tube (Figure 2). The tips of the arms will meet to form a rounded end that extends slightly beyond the insertion tube.

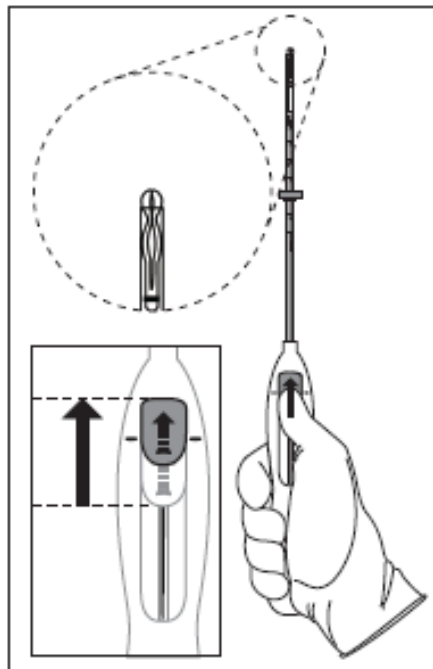

Figure 2. Move slider all the way to the forward position to load Skyla

- Maintain forward pressure with your thumb or forefinger on the slider. DO NOT move the slider downward at this time as this may prematurely release the threads of Skyla. Once the slider is moved below the mark, Skyla cannot be re-loaded.

Step 3—Setting the Flange

- Holding the slider in this forward position, set the upper edge of the flange to correspond to the uterine depth (in centimeters) measured during sounding (Figure 3).

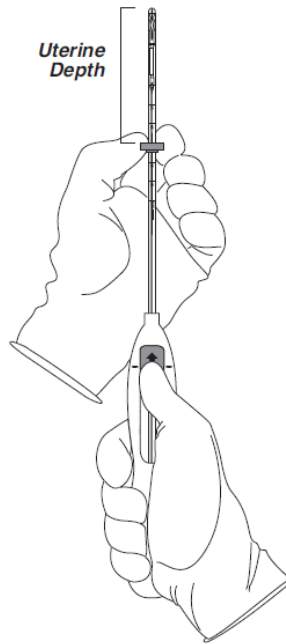

Figure 3. Setting the flange

Step 4—Skyla is now ready to be inserted

- Continue holding the slider in this forward position. Advance the inserter through the cervix until the flange is approximately 1.5–2 cm from the cervix and then pause (Figure 4).

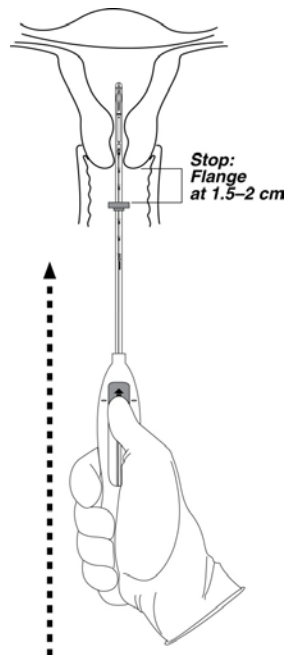

Figure 4. Advancing insertion tube until flange is 1.5 to 2 cm from the cervix

Do not force the inserter. If necessary, dilate the cervical canal.

Step 5–Open the arms

- While holding the inserter steady, move the slider down to the mark to release the arms of Skyla (Figure 5). Wait 10 seconds for the horizontal arms to open completely.

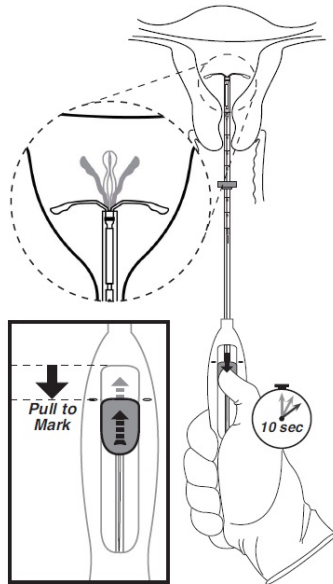

Figure 5. Move the slider back to the mark to release and open the arms

Step 6–Advance to fundal position

Advance the inserter gently towards the fundus of the uterus until the flange touches the cervix. If you encounter fundal resistance do not continue to advance. Skyla is now in the fundal position (Figure 6). Fundal positioning of Skyla is important to prevent expulsion.

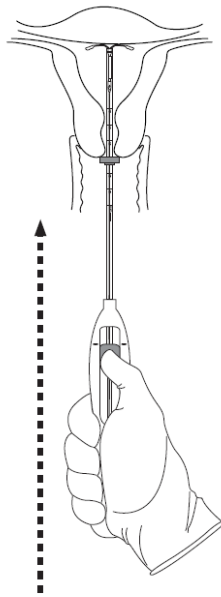

Figure 6. Move Skyla into the fundal position

Step 7—Release Skyla and withdraw the inserter

- Holding the entire inserter firmly in place, release Skyla by moving the slider all the way down (Figure 7).

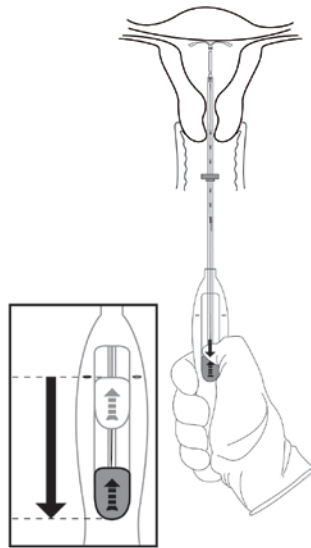

Figure 7. Move the slider all the way down to release Skyla from the insertion tube

- Continue to hold the slider all the way down while you slowly and gently withdraw the inserter from the uterus.
- Using a sharp, curved scissor, cut the threads perpendicular, leaving about 3 cm visible outside of the cervix [cutting threads at an angle may leave sharp ends (Figure 8)]. Do not apply tension or pull on the threads when cutting to prevent displacing Skyla.

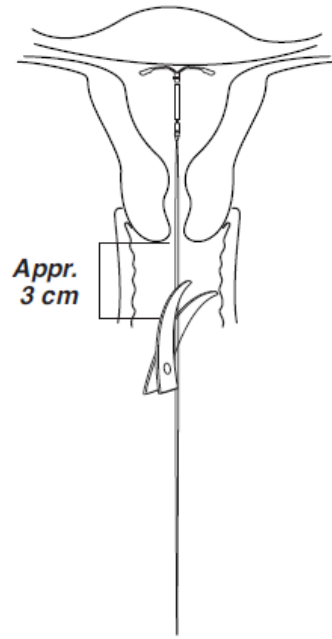

Figure 8. Cutting the threads

Skyla insertion is now complete. Prescribe analgesics, if indicated. Record the Skyla lot number in the patient records.

Important information to consider during or after insertion

- If you suspect that Skyla is not in the correct position, check placement (for example, using transvaginal ultrasound). Remove Skyla if it is not positioned completely within the uterus. Do not reinsert a removed Skyla.
- If there is clinical concern, exceptional pain or bleeding during or after insertion, take appropriate steps (such as physical examination and ultrasound) immediately to exclude perforation.

2.3 Patient Follow-up

- Reexamine and evaluate patients 4 to 6 weeks after insertion and once a year thereafter, or more frequently if clinically indicated.

2.4 Removal of Skyla

Timing of Removal

- Skyla should not remain in the uterus after 3 years.
- If pregnancy is not desired, remove Skyla during the first 7 days of the menstrual cycle, provided the woman is still experiencing regular menses. If removal will occur at other times during the cycle or the woman does not experience regular menses, she is at risk of pregnancy; start a new contraceptive method a week prior to removal for these women. [See *Dosage and Administration* (2.5).]

Tools for Removal

Preparation

- Gloves
- Speculum

Procedure

- Sterile forceps

Removal Procedure

- Remove Skyla by applying gentle traction on the threads with forceps (Figure 9).

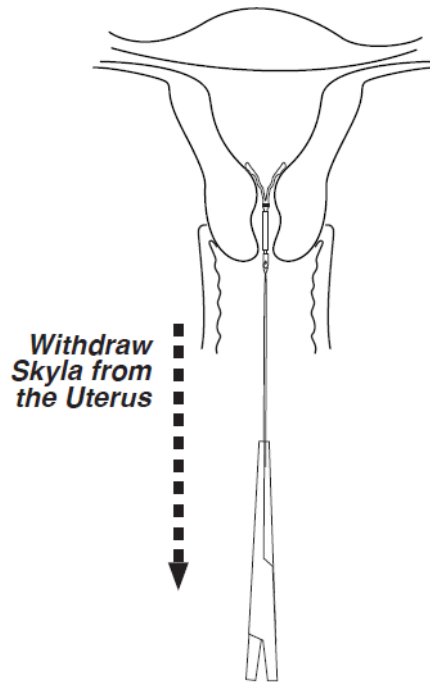

Figure 9. Removal of Skyla

- If the threads are not visible, determine location of Skyla by ultrasound [*see Warnings and Precautions (5.10)*].
- If Skyla is found to be in the uterine cavity on ultrasound exam, it may be removed using a narrow forceps, such as an alligator forceps. This may require dilation of the cervical canal. After removal of Skyla, examine the system to ensure that it is intact.
- Removal may be associated with some pain and/or bleeding or vasovagal reactions (for example, syncope, bradycardia) or seizure, especially in patients with a predisposition to these conditions.

2.5 Continuation of Contraception after Removal

- If pregnancy is not desired and if a woman wishes to continue using Skyla, a new system can be inserted immediately after removal any time during the cycle.
- If a patient with regular cycles wants to start a different contraceptive method, time removal and initiation of the new method to ensure continuous contraception. Either remove Skyla during the first 7 days of the menstrual cycle and start the new method immediately thereafter or start the new method at least 7 days prior to removing Skyla if removal is to occur at other times during the cycle.
- If a patient with irregular cycles or amenorrhea wants to start a different contraceptive method, start the new method at least 7 days before removal.

3 DOSAGE FORMS AND STRENGTHS

Skyla is a LNG-releasing IUS (a type of intrauterine device, or IUD) consisting of a T-shaped polyethylene frame with a steroid reservoir containing a total of 13.5 mg LNG.

4 CONTRAINDICATIONS

The use of Skyla is contraindicated when one or more of the following conditions exist:

- Pregnancy or suspicion of pregnancy [*see Warnings and Precautions (5.2), Use in Specific Populations (8.1)*]
- For use as post-coital contraception (emergency contraception)
- Congenital or acquired uterine anomaly including fibroids, that distorts the uterine cavity
- Acute pelvic inflammatory disease (PID) or a history of PID unless there has been a subsequent intrauterine pregnancy [*see Warnings and Precautions (5.4)*]
- Postpartum endometritis or infected abortion in the past 3 months
- Known or suspected uterine or cervical malignancy
- Known or suspected breast cancer or other progestin-sensitive cancer, now or in the past
- Uterine bleeding of unknown etiology
- Untreated acute cervicitis or vaginitis, including bacterial vaginosis or other lower genital tract infections until infection is controlled
- Acute liver disease or liver tumor (benign or malignant)
- Conditions associated with increased susceptibility to pelvic infections [*see Warnings and Precautions (5.4)*]
- A previously inserted intrauterine device (IUD) that has not been removed
- Hypersensitivity to any component of this product [*see Adverse Reactions (6.2) and Description (11.1)*]

5 WARNINGS AND PRECAUTIONS

5.1 Risk of Ectopic Pregnancy

Evaluate women for ectopic pregnancy if they become pregnant with Skyla in place because the likelihood of a pregnancy being ectopic is increased with Skyla. Approximately one-half of pregnancies that occur with Skyla in place are likely to be ectopic. Also consider the possibility of ectopic pregnancy in the case of lower abdominal pain, especially in association with missed menses or if an amenorrheic woman starts bleeding.

The incidence of ectopic pregnancy in clinical trials with Skyla, which excluded women with a history of ectopic pregnancy, was approximately 0.1% per year. The risk of ectopic pregnancy in women who have a history of ectopic pregnancy and use Skyla is unknown. Women with a previous history of ectopic pregnancy, tubal surgery or pelvic infection carry a higher risk of ectopic pregnancy. Ectopic pregnancy may result in loss of fertility.

5.2 Risks with Intrauterine Pregnancy

If pregnancy occurs while using Skyla, remove Skyla because leaving it in place may increase the risk of spontaneous abortion and preterm labor. Removal of Skyla or probing of the uterus may also result in spontaneous abortion. In the event of an intrauterine pregnancy with Skyla, consider the following:

Septic abortion

In patients becoming pregnant with an IUS in place, septic abortion—with septicemia, septic shock, and death—may occur.

Continuation of pregnancy

If a woman becomes pregnant with Skyla in place and if Skyla cannot be removed or the woman chooses not to have it removed, warn her that failure to remove Skyla increases the risk of miscarriage, sepsis, premature labor and premature delivery. Advise her of isolated reports of virilization of the female fetus following local exposure to LNG during pregnancy with an LNG IUS in place [*see Use in Specific Populations (8.1)*]. Follow her pregnancy closely and advise her to report immediately any symptom that suggests complications of the pregnancy.

5.3 Sepsis

Severe infection or sepsis, including Group A streptococcal sepsis (GAS), have been reported following insertion of a LNG-releasing IUS. In some cases, severe pain occurred within hours of insertion followed by sepsis within days. Because death from GAS is more likely if treatment is delayed, it is important to be aware of these rare but serious infections. Aseptic technique during insertion of Skyla is essential in order to minimize serious infections such as GAS.

5.4 Pelvic Infection

Promptly examine users with complaints of lower abdominal or pelvic pain, odorous discharge, unexplained bleeding, fever, genital lesions or sores. Remove Skyla in cases of recurrent endometritis or pelvic inflammatory disease, or if an acute pelvic infection is severe or does not respond to treatment.

Pelvic Inflammatory Disease (PID)

Skyla is contraindicated in the presence of known or suspected PID or in women with a history of PID unless there has been a subsequent intrauterine pregnancy [see *Contraindications* (4)]. IUDs have been associated with an increased risk of PID, most likely due to organisms being introduced into the uterus during insertion. In clinical trials, PID was observed in 0.4% of women overall and occurred more frequently within the first year and most often within the first month after insertion of Skyla.

Women at increased risk for PID

PID is often associated with a sexually transmitted infection (STI), and Skyla does not protect against STI. The risk of PID is greater for women who have multiple sexual partners, and also for women whose sexual partner(s) have multiple sexual partners. Women who have had PID are at increased risk for a recurrence or re-infection. In particular, ascertain whether the woman is at increased risk of infection (for example, leukemia, acquired immune deficiency syndrome [AIDS], intravenous drug abuse).

Subclinical PID

PID may be asymptomatic but still result in tubal damage and its sequelae.

Treatment of PID

Following a diagnosis of PID, or suspected PID, bacteriologic specimens should be obtained, and antibiotic therapy should be initiated promptly. Removal of Skyla after initiation of antibiotic therapy is usually appropriate.¹

Actinomycosis

Actinomycosis has been associated with IUDs. Remove Skyla from symptomatic women and treat with antibiotics. The significance of actinomyces-like organisms on Pap smear in an asymptomatic IUD user is unknown, and so this finding alone does not always require Skyla removal and treatment. When possible, confirm a Pap smear diagnosis with cultures.

5.5 Perforation

Perforation (total or partial, including penetration/embedment of Skyla in the uterine wall or cervix) may occur most often during insertion, although the perforation may not be detected until sometime later. The incidence of perforation during clinical trials was < 0.1%.

The risk of uterine perforation is increased in women who have recently given birth, and in women who are breastfeeding at the time of insertion. In a large postmarketing safety study conducted in the US, the risk of uterine perforation was highest when insertion occurred within ≤ 6 weeks postpartum, and also higher with breastfeeding at the time of insertion [see *Adverse Reactions* (6.2)].

The risk of perforation may be increased if Skyla is inserted when the uterus is fixed, retroverted or not completely involuted.

If perforation occurs, locate and remove Skyla. Surgery may be required. Delayed detection or removal of Skyla in case of perforation may result in migration outside the uterine cavity, adhesions, peritonitis, intestinal perforations, intestinal

obstruction, abscesses and erosion of adjacent viscera. In addition, perforation may reduce contraceptive efficacy and result in pregnancy.

5.6 Expulsion

Partial or complete expulsion of Skyla may occur resulting in the loss of efficacy. Expulsion may be associated with symptoms of bleeding or pain, or it may be asymptomatic and go unnoticed. Skyla typically decreases menstrual bleeding over time; therefore, an increase of menstrual bleeding may be indicative of an expulsion. Consider further diagnostic imaging, such as x-ray, if expulsion is suspected based on ultrasound [see *Warnings and Precautions (5.10)*]. In clinical trials, a 3-year expulsion rate of 3.2% (54 out of 1,665 subjects) was reported.

The risk of expulsion is increased with insertions immediately after delivery and appears to be increased with insertion after second-trimester abortion based on limited data. In a large postmarketing safety study conducted in the US, the risk of expulsion was lower with breastfeeding status [see *Adverse Reactions (6.2)*].

Remove a partially expelled Skyla. If expulsion has occurred, a new Skyla can be inserted any time the provider can be reasonably certain the woman is not pregnant.

5.7 Ovarian Cysts

Because the contraceptive effect of Skyla is mainly due to its local effects within the uterus, ovulatory cycles with follicular rupture usually occur in women of fertile age using Skyla. Ovarian cysts (reported as adverse reactions if they were abnormal, non-functional cysts and/or had a diameter >3 cm on ultrasound examination) were reported at least once over the course of clinical trials in 13.2% of women using Skyla, and 0.3% of subjects discontinued because of an ovarian cyst. Most ovarian cysts are asymptomatic, although some may be accompanied by pelvic pain or dyspareunia. In most cases the ovarian cysts disappear spontaneously during two to three months observation. Evaluate persistent ovarian cysts. Surgical intervention is not usually required.

5.8 Bleeding Pattern Alterations

Skyla can alter the bleeding pattern and result in spotting, irregular bleeding, heavy bleeding, oligomenorrhea and amenorrhea. During the first 3–6 months of Skyla use, the number of bleeding and spotting days may be higher and bleeding patterns may be irregular. Thereafter, the number of bleeding and spotting days usually decreases but bleeding may remain irregular.

In Skyla clinical trials, amenorrhea developed by the end of the first year of use in approximately 6% of Skyla users. A total of 77 subjects out of 1,672 (4.6%) discontinued due to uterine bleeding complaints. Table 2 shows the bleeding patterns as documented in the Skyla clinical trials based on 90-day reference periods. Table 3 shows the number of bleeding and spotting days based on 28-day cycle equivalents.

Table 2: Bleeding Patterns Reported with Skyla in Contraception Studies (by 90-day reference periods)

Skyla	First 90 days N=1,531	Second 90 days N=1,475	End of year 1 N=1,329	End of year 3 N=903
Amenorrhea ¹	<1%	3%	6%	12%
Infrequent bleeding ²	8%	19%	20%	22%
Frequent bleeding ³	31%	12%	8%	4%
Prolonged bleeding ⁴	55%	14%	6%	2%
Irregular bleeding ⁵	39%	25%	18%	15%

¹Defined as subjects with no bleeding/spotting throughout the 90-day reference period

²Defined as subjects with 1 or 2 bleeding/spotting episodes in the 90-day reference period

³Defined as subjects with more than 5 bleeding/spotting episodes in the 90-day reference period

⁴Defined as subjects with bleeding/spotting episodes lasting more than 14 days in the 90-day reference period. Subjects with prolonged bleeding may also be included in one of the other categories (excluding amenorrhea)

⁵Defined as subjects with 3 to 5 bleeding/spotting episodes and less than 3 bleeding/spotting-free intervals of 14 or more days.

Table 3: Mean number of Bleeding and Spotting Days per 28-day Cycle Equivalent

28-day Cycle Equivalent	Cycle 1 N=1,588	Cycle 4 N=1,535	Cycle 7 N=1,468	Cycle 13 N=1,345	Cycle 39 N=781
Days on treatment	1–28	85–112	169–196	337–364	1065–1092
	Mean (SD)	Mean (SD)	Mean (SD)	Mean (SD)	Mean (SD)
Number of bleeding days	7.3 (5.6)	3.5 (3.4)	2.8 (3.1)	2.1 (2.7)	1.4 (2.1)
Number of spotting days	9.2 (6.1)	4.8 (4.4)	3.8 (3.6)	3.3 (3.1)	2.7 (2.7)

If a significant change in bleeding develops during prolonged use, take appropriate diagnostic measures to rule out endometrial pathology. Consider the possibility of pregnancy if menstruation does not occur within six weeks of the onset of a previous menstruation. Once pregnancy has been excluded, repeated pregnancy tests are generally not necessary in amenorrheic women unless indicated, for example, by other signs of pregnancy or by pelvic pain.

5.9 Breast Cancer

Women who currently have or have had breast cancer, or have a suspicion of breast cancer, should not use hormonal contraception, including Skyla, because some breast cancers are hormone-sensitive [*see Contraindications (4)*].

Spontaneous reports of breast cancer have been received during postmarketing experience with a LNG-releasing IUS. Observational studies of the risk of breast cancer with use of a LNG-releasing IUS do not provide conclusive evidence of increased risk.

5.10 Clinical Considerations for Use and Removal

Use Skyla with caution after careful assessment if any of the following conditions exist, and consider removal of the system if any of them arise during use:

- Coagulopathy or use of anticoagulants
- Migraine, focal migraine with asymmetrical visual loss or other symptoms indicating transient cerebral ischemia
- Exceptionally severe headache
- Marked increase of blood pressure
- Severe arterial disease such as stroke or myocardial infarction

In addition, consider removing Skyla if any of the following conditions arise during use:

- Uterine or cervical malignancy
- Jaundice

If the threads are not visible or are significantly shortened, they may have broken or retracted into the cervical canal or uterus. Consider the possibility that the system may have been displaced (for example, expelled or perforated the uterus) [*see Warnings and Precautions (5.5, 5.6)*]. Exclude pregnancy and verify the location of Skyla, for example, by sonography, X-ray, or by gentle exploration of the cervical canal with a suitable instrument. If Skyla is displaced, remove it. A new Skyla may be inserted at that time or during the next menses if it is certain that conception has not occurred. If Skyla is in place with no evidence of perforation, no intervention is indicated.

5.11 Magnetic Resonance Imaging (MRI) Safety Information



Non-clinical testing has demonstrated that Skyla is MR Conditional. A patient with Skyla can be safely scanned in an MR system meeting the following conditions:

- Static magnetic field of 3.0 T or less
- Maximum spatial field gradient of 36,000 gauss/cm (360 T/m)
- Maximum MR system reported, whole body averaged specific absorption rate (SAR) of 4W/kg (First Level Controlled Operating Mode)

Under the scan conditions defined above, the Skyla IUS is expected to produce a maximum temperature rise of less than 2°C after 15 minutes of continuous scanning.

In non-clinical testing, the image artifact caused by the IUS extended up to 5 mm from the IUS when imaged with a gradient echo pulse sequence and a 3.0 T MRI system.

6 ADVERSE REACTIONS

The following serious or otherwise important adverse reactions are discussed elsewhere in the labeling:

- Ectopic Pregnancy [*see Warnings and Precautions (5.1)*]
- Intrauterine Pregnancy [*see Warnings and Precautions (5.2)*]
- Group A Streptococcal Sepsis (GAS) [*see Warnings and Precautions (5.3)*]
- Pelvic Inflammatory Disease [*see Warnings and Precautions (5.4)*]
- Perforation [*see Warnings and Precautions (5.5)*]
- Expulsion [*see Warnings and Precautions (5.6)*]
- Ovarian Cysts [*see Warnings and Precautions (5.7)*]
- Bleeding Pattern Alterations [*see Warnings and Precautions (5.8)*]

6.1 Clinical Trials Experience

Because clinical trials are conducted under widely varying conditions, adverse reaction rates observed in the clinical trials of a drug cannot be directly compared to rates in the clinical trials of another drug and may not reflect the rates observed in clinical practice.

The data described below reflect exposure to Skyla in 1,672 patients in two contraception studies, including 1,383 exposed for one year and 993 who completed the three year studies. The population was generally healthy, 18 to 40-year old females requesting contraception and predominately Caucasian (82.6%). The data cover more than 40,000 cycles of exposure. The frequencies of reported adverse drug reactions represent crude incidences.

Most common adverse reactions (occurring in $\geq 5\%$ users) were increased bleeding (7.8%), vulvovaginitis (20.2%), abdominal/pelvic pain (18.9%), acne/seborrhea (15.0%), ovarian cyst (13.2%), headache (12.4%), dysmenorrhea (8.6%), breast pain/discomfort (8.6%) and nausea (5.5%).

In the contraception studies, 18% discontinued prematurely due to an adverse reaction. The most common adverse reactions leading to discontinuation (in $>1\%$ of users) were uterine bleeding complaints (4.6%), device expulsion (3.2%), acne/seborrhea (2.9%), abdominal pain (2.5%) dysmenorrhea/uterine spasms (2.0%) and pelvic pain (1.8%).

Other common adverse reactions (occurring in $\geq 1\%$ users) by System Organ Class (SOC): The frequencies of adverse reactions observed in clinical trials are summarized in Table 4 by SOC (presented as crude incidences).

Table 4: Adverse reactions that occurred in at least 1% of Skyla users in clinical trials by SOC

System Organ Class	Adverse Reaction	Incidence (%) (N=1,672)
Reproductive System and Breast Disorders	Vulvovaginitis	20.2
	Ovarian cyst ^a	13.2
	Dysmenorrhea	8.6
	Increased bleeding ^b	7.8
	Breast pain/discomfort	5.3/3.3
	Genital discharge	4.2
	Device expulsion (complete and partial)	3.2
	Upper genital tract infection	1.4
Gastrointestinal Disorders	Abdominal pain/pelvic pain	12.7/6.2
	Nausea	5.5
Skin and Subcutaneous Tissue Disorders	Acne/Seborrhea	13.6/1.4
	Alopecia	1.2
Nervous System Disorders	Headache	12.4
	Migraine	2.3
Psychiatric Disorders	Depression/Depressed mood	3.8/0.5

^a Ovarian cysts were reported as adverse events if they were abnormal, non-functional cysts and/or had a diameter >3 cm on ultrasound examination

^b Not all bleeding alterations were captured as adverse reactions [see *Warnings and Precautions (5.8)*].

6.2 Postmarketing Experience

Adverse Reactions from Postmarketing Spontaneous Reports

The following adverse reactions have been identified during post approval use of LNG-releasing IUSs. Because these reactions are reported voluntarily from a population of uncertain size, it is not always possible to reliably estimate their frequency or establish a causal relationship to drug exposure.

- Arterial thrombotic and venous thromboembolic events, including cases of pulmonary embolism, deep vein thrombosis and stroke
- Device breakage
- Hypersensitivity (including rash, urticaria, and angioedema)
- Increased blood pressure

Reported Adverse Reactions from Postmarketing Studies

Assessment of Perforation and Expulsion of Intrauterine Devices (APEX IUD) Study

APEX IUD was a large US retrospective cohort study to assess the impact of breastfeeding and timing of postpartum IUD insertion on uterine perforation and IUD expulsion. The analyses included a total of 326,658 insertions, 30% (97,824

insertions) of which were performed in women with a delivery in the previous 12 months. For insertions performed in women who had delivered ≤ 52 weeks before IUD insertion, the majority of postpartum insertions, 57.3% (56,047 insertions) occurred between 6 and 14 weeks postpartum. Breastfeeding data were available in 94,817 insertions performed in women 52 weeks or less after delivery.

The study results indicated that the risk of uterine perforation was highest in women with IUD insertion ≤ 6 weeks postpartum. Immediate postpartum insertion (0–3 days) findings are limited due to the relatively small number of insertions occurring within this time interval. Women who were breastfeeding at the time of insertion were at 33% higher risk of perforation (adjusted hazard ratio [HR]=1.33, 95% confidence interval [CI]: 1.07–1.64) compared to women who were not breastfeeding at the time of insertion. Progressively lower risk of uterine perforation was observed in postpartum time windows beyond 6 weeks, in both breastfeeding and not breastfeeding women. Table 5 presents the uterine perforation rates for LNG IUS stratified by breastfeeding status and postpartum interval.

Table 5: Uterine Perforation¹ rates for LNG IUS, by Breastfeeding Status and Postpartum Interval

Postpartum interval at time of insertion	Breastfeeding at time of insertion		Not breastfeeding at time of insertion	
	Number of events/ insertions	Uterine perforation rate per 1,000 insertions	Number of events/ insertions	Uterine perforation rate per 1,000 insertions
0 to 3 days	8/1,896	4.22	0/277	0.00
4 days to ≤ 6 weeks	120/10,735	11.18	28/2,377	11.78
> 6 to ≤ 14 weeks	268/29,677	9.03	30/12,011	6.66
> 14 to ≤ 52 weeks	43/6,139	7.00	22/9,089	2.42
> 52 weeks or no delivery	no data available		243/184,733	1.32

¹Uterine perforation includes both complete and partial perforation

Risk of expulsion was variable over the postpartum intervals through 52 weeks. Women who were breastfeeding were at 28% lower risk of IUD expulsion (adjusted HR=0.72, 95% CI: 0.64-0.80) compared to women who were not breastfeeding at time of insertion. Table 6 presents the IUD expulsion rates for LNG IUS stratified by breastfeeding status and postpartum interval.

Table 6: Expulsion¹ Rates for LNG IUS, by Breastfeeding Status and Postpartum Interval

Postpartum interval at time of insertion	Breastfeeding at time of insertion		Not breastfeeding at time of insertion	
	Number of events/ insertions	Expulsion rate per 1,000 insertions	Number of events/ insertions	Expulsion rate per 1,000 insertions
0 to 3 days	187/1,896	98.63	12/277	43.32
4 days to ≤ 6 weeks	185/10,735	17.23	52/2,377	21.88
> 6 to ≤ 14 weeks	421/29,677	14.19	306/12,011	25.48
> 14 to ≤ 52 weeks	120/6,139	19.55	273/9,089	30.04
> 52 weeks or no delivery	no data available		5,481/184,733	29.67

¹Expulsion includes both complete and partial expulsion

7 DRUG INTERACTIONS

No drug-drug interaction studies have been conducted with Skyla.

Drugs or herbal products that induce or inhibit LNG metabolizing enzymes, including CYP3A4, may decrease or increase, respectively, the serum concentrations of LNG during the use of Skyla. However, the contraceptive effect of Skyla is

mediated via the direct release of LNG into the uterine cavity and is unlikely to be affected by drug interactions via enzyme induction or inhibition.

8 USE IN SPECIFIC POPULATIONS

8.1 Pregnancy

Risk Summary

The use of Skyla is contraindicated in pregnancy or with a suspected pregnancy and Skyla may cause adverse pregnancy outcomes [see *Contraindications* (4), *Warnings and Precautions* (5.1, 5.2)]. If a woman becomes pregnant with Skyla in place, the likelihood of ectopic pregnancy is increased and there is an increased risk of miscarriage, sepsis, premature labor, and premature delivery. Remove Skyla, if possible, if pregnancy occurs in a woman using Skyla. If Skyla cannot be removed, follow the pregnancy closely [see *Warnings and Precautions* (5.1, 5.2)].

There have been isolated cases of virilization of the external genitalia of the female fetus following local exposure to LNG during pregnancy with an LNG IUS in place. Animal reproduction studies have not been conducted with Skyla.

8.2 Lactation

Risk Summary

Published studies report the presence of LNG in human milk. Small amounts of progestins (approximately 0.1% of the total maternal doses) were detected in the breast milk of nursing mothers who used other LNG-releasing IUSs, resulting in exposure of LNG to the breastfed infants. There are no reports of adverse effects in breastfed infants with maternal use of progestin-only contraceptives. Isolated cases of decreased milk production have been reported with a LNG-releasing IUS. The developmental and health benefits of breastfeeding should be considered along with the mother's clinical need for Skyla and any potential adverse effects on the breastfed child from Skyla or from the underlying maternal condition.

8.3 Females and Males of Reproductive Potential

Return to Fertility After Discontinuing Skyla

About 77% of women who desired pregnancy after study discontinuation and provided follow-up information, conceived within 12 months after removal of Skyla.

8.4 Pediatric Use

Safety and efficacy of Skyla have been established in women of reproductive age. Efficacy is expected to be the same for postpubertal females under the age of 18 as for users 18 years and older. Use of this product before menarche is not indicated.

8.5 Geriatric Use

Skyla has not been studied in women over age 65 and is not approved for use in this population.

11 DESCRIPTION

Skyla (levonorgestrel-releasing intrauterine system) contains 13.5 mg of LNG, a progestin, and is intended to provide an initial release rate of approximately 14 mcg/day of LNG after 24 days.

Levonorgestrel USP, (-)-13-Ethyl-17-hydroxy-18,19-dinor-17 α -pregn-4-en-20-yn-3-one, the active ingredient in Skyla, has a molecular weight of 312.4, a molecular formula of C₂₁H₂₈O₂, and the following structural formula:

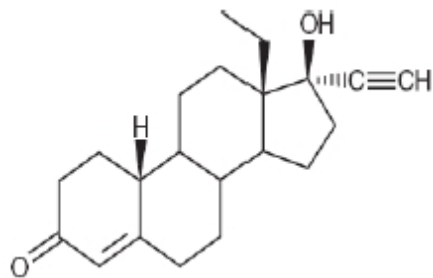

11.1 Skyla

Skyla consists of a T-shaped polyethylene frame (T-body) with a steroid reservoir (hormone elastomer core) around the vertical stem. The white T-body has a loop at one end of the vertical stem and two horizontal arms at the other end. The reservoir consists of a whitish or pale yellow cylinder, made of a mixture of LNG and silicone (polydimethylsiloxane), containing a total of 13.5 mg LNG. The reservoir is covered by a semi-opaque silicone membrane, composed of polydimethylsiloxane and colloidal silica. A ring composed of 99.95% pure silver is located at the top of the vertical stem close to the horizontal arms and is visible by ultrasound. The polyethylene of the T-body is compounded with barium sulfate, which makes it radiopaque. A monofilament brown polyethylene removal thread is attached to a loop at the end of the vertical stem of the T-body. The polyethylene of the removal thread contains iron oxide as a colorant (see Figure 10).

The components of Skyla, including its packaging, are not manufactured using natural rubber latex.

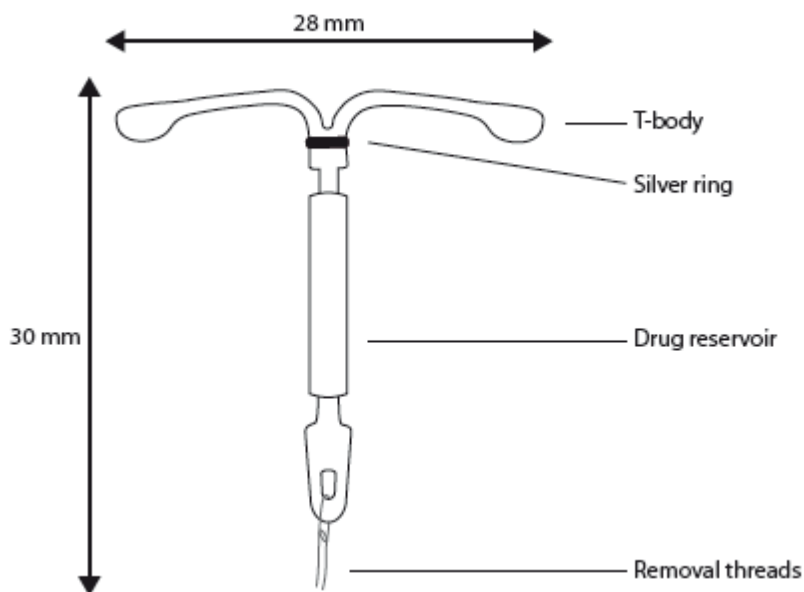

Figure 10. Skyla

11.2 Inserter

Skyla is packaged sterile within an inserter. The inserter (Figure 11), which is used for insertion of Skyla into the uterine cavity, consists of a symmetric two-sided body and slider that are integrated with flange, lock, pre-bent insertion tube and plunger. The outer diameter of the insertion tube is 3.8 mm. The vertical stem of Skyla is loaded in the insertion tube at the tip of the inserter. The arms are pre-aligned in the horizontal position. The removal threads are contained within the insertion tube and handle. Once Skyla has been placed, the inserter is discarded.

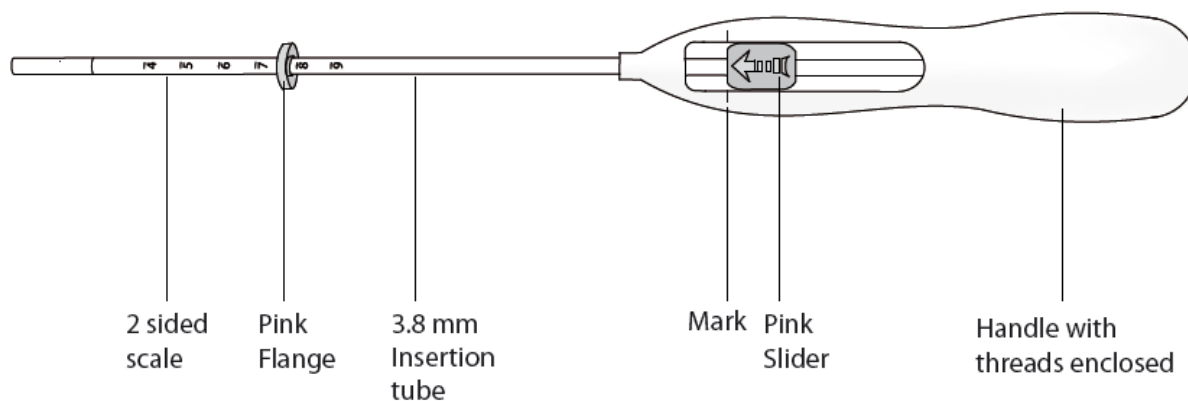

Figure 11. Diagram of Inserter

12 CLINICAL PHARMACOLOGY

12.1 Mechanism of Action

The local mechanism by which continuously released LNG contributes to the contraceptive effectiveness of Skyla has not been conclusively demonstrated. Studies of Skyla and similar LNG IUS prototypes have suggested several mechanisms that prevent pregnancy: thickening of cervical mucus preventing passage of sperm into the uterus, inhibition of sperm capacitation or survival, and alteration of the endometrium.

12.2 Pharmacodynamics

Skyla has mainly local progestogenic effects in the uterine cavity. The local concentrations of LNG lead to morphological changes including stromal pseudodecidualization, glandular atrophy, a leukocytic infiltration and a decrease in glandular and stromal mitoses.

In clinical trials with Skyla, ovulation was assessed based on serum progesterone values >2.5 ng/mL in one study and serum progesterone values >2.5 ng/mL together with serum estradiol levels <27.24 pg/mL in another study. Evidence of ovulation by these criteria was seen in 34 out of 35 women in the first year, in 26 out of 27 women in the second year, and in all 26 women in the third year.

12.3 Pharmacokinetics

Absorption

Low doses of LNG are administered into the uterine cavity with the Skyla intrauterine delivery system. The *in vivo* release rate is approximately 14 mcg/day after 24 days and is reduced to approximately 10 mcg/day after 60 days and then declines progressively to approximately 6 mcg/day after 1 year and 5 mcg/day after 3 years. The average LNG *in vivo* release rate is approximately 8 mcg/day over the first year of use and 6 mcg/day over the period of 3 years.

In a subset of 7 subjects, the maximum observed serum LNG concentration (mean \pm SD) was 192 ± 105 pg/mL, reached after 2 days (median) of Skyla insertion. Thereafter, the LNG serum concentrations (mean \pm SD) at year 1, 2, and 3 were 77 ± 21 pg/mL, 62 ± 38 pg/mL, and 72 ± 29 pg/mL, respectively. A population pharmacokinetic evaluation based on a broader database (>1000 patients) showed similar concentration data of 168 ± 46 pg/mL at 7 days after placement. Thereafter, LNG serum concentrations decline slowly to a value 61 ± 19 pg/mL after 3 years.

Distribution

The apparent volume of distribution of LNG is reported to be approximately 1.8 L/kg. LNG is bound non-specifically to serum albumin and specifically to sex hormone binding globulin (SHBG). Accordingly, changes in the concentration of SHBG in serum result in an increase (at higher SHBG concentration) or a decrease (at lower SHBG concentration) of the

total LNG concentration in serum. In a subset of 7 subjects, the concentration of SHBG declined by a mean value of 18% within 2 weeks after insertion of Skyla and remained relatively stable over the 3 year period of use. Less than 2% of the circulating LNG is present as free steroid.

Elimination

Following intravenous administration of 0.09 mg LNG to healthy volunteers, the total clearance of LNG is approximately 1 mL/min/kg and the elimination half-life is approximately 20 hours. Metabolic clearance rates may differ among individuals by several-fold, and this may account in part for wide individual variations in LNG concentrations seen in individuals using LNG-containing contraceptive products.

Metabolism

Following absorption, LNG is extensively metabolized. The most important metabolic pathways are the reduction of the Δ^4 -3-oxo group and hydroxylations at positions 2 α , 1 β and 16 β , followed by conjugation. Significant amounts of conjugated and unconjugated 3 α , 5 β - are also present in serum, along with much smaller amounts of 3 α , 5 α -tetrahydrolevonorgestrel and 16 β -hydroxylevonorgestrel. CYP3A4 is the main enzyme involved in the oxidative metabolism of LNG.

Excretion

LNG and its phase I metabolites are excreted primarily as glucuronide conjugates. About 45% of LNG and its metabolites are excreted in the urine and about 32% are excreted in feces, mostly as glucuronide conjugates.

Specific Populations

Pediatric: Safety and efficacy of Skyla have been established in women of reproductive age. Use of this product before menarche is not indicated.

In a one-year phase 3 study in post-menarcheal female adolescents (mean age 16.2, range 12 to 18 years) using Skyla, the population pharmacokinetic analysis of 278 adolescents showed mean estimated LNG serum concentrations slightly higher (approximately 10%) in adolescents compared to prior data in adults. This correlates to the generally lower body weight in adolescents. The ranges estimated for adolescents lie within the ranges estimated for adults.

Geriatric: Skyla has not been studied in women over age 65 and is not approved for use in this population.

Race: A three-year phase 3 study in the Asian-Pacific region (93% Asian women, the majority of whom were Chinese, 7% other ethnicities) using Skyla was performed. The population pharmacokinetic analysis of the Asian (Chinese) population in this study showed that estimated LNG serum concentrations in Asian women were slightly higher (approximately 4 to 16%) than those in another phase 3 study which was performed in mainly Caucasian women (79.7%). This slightly higher exposure might be explained by the lower body weight of Asian women.

Hepatic Impairment: No studies were conducted to evaluate the effect of hepatic disease on the disposition of Skyla.

Renal Impairment: No formal studies were conducted to evaluate the effect of renal disease on the disposition of Skyla.

Drug-Drug Interactions

No drug-drug interaction studies were conducted with Skyla [see *Drug Interactions* (7)].

13 NONCLINICAL TOXICOLOGY

13.1 Carcinogenesis, Mutagenesis, Impairment of Fertility

[See *Warnings and Precautions* (5.9).]

14 CLINICAL STUDIES

The contraceptive efficacy of Skyla was evaluated in a clinical trial that enrolled generally healthy women aged 18–35, 1,432 of whom received Skyla. Of these, 38.8 % (556) were nulliparous women, and 819 women completed 3 years of use. The trial was a multicenter, multi-national, randomized open-label study conducted in 11 countries in Europe, Latin America, the US and Canada. Women less than six weeks postpartum, with a history of ectopic pregnancy, with clinically significant ovarian cysts or with HIV or otherwise at high risk for sexually transmitted infections were excluded. A total of 540 (37.7%) were treated at US sites and 892 (62.3%) were at non-US sites. The racial demographics of enrolled women who received Skyla was: Caucasian (79.7%), Hispanic (11.5%), Black/African Americans (5.2%), Other (2.7%) and Asian (0.8%). The weight range was 38 to 155 kg (mean weight: 68.7 kg) and mean BMI was 25.3 kg/m² (range 16–55 kg/m²). The clinical trial had no upper or lower weight or BMI limit. Of Skyla-treated women, 21.9% discontinued the study treatment due to an adverse event, 4.4% were lost to follow up, 1.8% withdrew for unspecified reasons, 1.1% discontinued due to protocol deviation, 0.6% discontinued due to pregnancy, and 13.0% discontinued due to other reasons.

The pregnancy rate calculated as the Pearl Index (PI) in women aged 18–35 years was the primary efficacy endpoint used to assess contraceptive reliability. The PI was calculated based on 28-day equivalent exposure cycles; evaluable cycles excluded those in which back-up contraception was used unless a pregnancy occurred in that cycle. Skyla-treated women provided 15,763 evaluable 28-day cycle equivalents in the first year and 39,368 evaluable cycles over the three year treatment period. The PI estimate for the first year of use based on the 5 pregnancies that occurred after the onset of treatment and within 7 days after Skyla removal or expulsion was 0.41 with a 95% upper confidence limit of 0.96. The cumulative 3-year pregnancy rate, based on 10 pregnancies, estimated by the Kaplan-Meier method was 0.9 per 100 women or 0.9%, with a 95% upper confidence limit of 1.7%.

15 REFERENCES

¹ <http://www.cdc.gov/std/tg2015/pid.htm>. Accessed August 22, 2016.

16 HOW SUPPLIED/STORAGE AND HANDLING

Skyla (levonorgestrel-releasing intrauterine system), containing a total of 13.5 mg LNG, is available in a carton of one sterile unit. NDC# 50419-422-01

Skyla is supplied sterile. Skyla is sterilized with ethylene oxide. Do not resterilize. For single use only. Do not use if the inner package is damaged or open. Insert before the end of the month shown on the label.

Store at 25°C (77°F); with excursions permitted between 15–30°C (59–86°F) [see USP Controlled Room Temperature].

17 PATIENT COUNSELING INFORMATION

Advise the patient to read the FDA-approved patient labeling (Patient Information)

- **Sexually Transmitted Infections:** Advise the patient that this product does not protect against HIV infection (AIDS) and other sexually transmitted infections (STIs).
- **Risk of Ectopic Pregnancy:** Advise the patient about the risks of ectopic pregnancy, including the loss of fertility. Teach her to recognize and report to her healthcare provider promptly any symptoms of ectopic pregnancy. [*See Warnings and Precautions (5.1).*]
- **Risks of Intrauterine Pregnancy:** Advise the patient to contact her healthcare provider if she thinks she might be pregnant. Inform the patient about the risks of intrauterine pregnancy while using Skyla, including the risks of leaving Skyla in place and the risks of removing Skyla or probing of the uterus. If Skyla cannot be removed in a pregnant patient, advise her to report immediately any symptom that suggests complications of the pregnancy. Advise her of isolated reports of virilization of the female fetus following local exposure to LNG during pregnancy with an LNG IUS in place. [*See Warnings and Precautions (5.2) and Use in Special Populations (8.1).*]

- **Sepsis:** Advise the patient that severe infection or sepsis, including Group A streptococcal sepsis (GAS), can occur within the first few days after Skyla is inserted. Instruct her to contact a healthcare provider immediately if she develops severe pain or fever shortly after Skyla is inserted. *[See Warnings and Precautions (5.3).]*
- **Pelvic Infection:** Advise the patient about the possibility of pelvic infections including PID and that these infections can cause tubal damage leading to ectopic pregnancy or infertility, or infrequently can necessitate hysterectomy, or cause death. Teach patients to recognize and report to their healthcare provider promptly any symptoms of pelvic infection. These symptoms include development of menstrual disorders (prolonged or heavy bleeding), unusual vaginal discharge, abdominal or pelvic pain or tenderness, dyspareunia, chills, and fever. *[See Warnings and Precautions (5.4).]*
- **Perforation and Expulsion:** Advise the patient that the IUS may be expelled from or perforate the uterus and instruct her on how she can check that the threads still protrude from the cervix. Inform her that excessive pain or vaginal bleeding during Skyla placement, worsening pain or bleeding after placement, or the inability to feel Skyla strings may occur with Skyla perforation and expulsion. Caution her not to pull on the threads and displace Skyla. Inform her that there is no contraceptive protection if Skyla is displaced or expelled. Instruct the patient to contact her healthcare provider if she cannot feel the threads and to avoid intercourse or use a non-hormonal back-up birth control (such as condoms or spermicide) until the location of Skyla has been confirmed. Advise her that if perforation occurs, Skyla will have to be located and removed; surgery may be required. *[See Warnings and Precautions (5.5, 5.6, 5.10).]*
- **Ovarian Cysts:** Advise the patient regarding the risk of ovarian cysts and that cysts can cause clinical symptoms including pelvic pain, abdominal pain or dyspareunia. Advise the patient to contact her healthcare provider if she experiences these symptoms. *[See Warnings and Precautions (5.7).]*
- **Bleeding Pattern Alterations:** Advise the patient that irregular or prolonged bleeding and spotting, and/or cramps may occur during the first few weeks after insertion. Inform the patient that, during the first 3–6 months of Skyla use, the number of bleeding and spotting days may be higher and bleeding patterns may be irregular. If her symptoms continue or are severe, she should report them to her healthcare provider. *[See Warnings and Precautions (5.8).]*
- **Clinical Considerations for Use and Removal:** Advise the patient to contact her healthcare provider if she experiences any of the following:
 - A stroke or heart attack
 - Very severe or migraine headaches
 - Unexplained fever
 - Yellowing of the skin or whites of the eyes, as these may be signs of serious liver problems
 - Pregnancy or suspected pregnancy
 - Pelvic pain, abdominal pain, or pain during sex
 - HIV positive seroconversion in herself or her partner
 - Possible exposure to STIs
 - Unusual vaginal discharge or genital sores
 - Severe vaginal bleeding or bleeding that lasts a long time, or if she misses a menstrual period
 - Inability to feel Skyla's threads
- **Magnetic Resonance Imaging (MRI) Safety Information:** Inform the patient that Skyla can be safely scanned with MRI only under specific conditions *[see Warnings and Precautions (5.11)]*. Instruct patients who will have an MRI to tell their doctor that they have Skyla.

Manufactured for:

Bayer HealthCare Pharmaceuticals Inc.

Whippany, NJ 07981

© 2013, Bayer HealthCare Pharmaceuticals Inc.

All rights reserved.

Patient Information

Skyla (sky-lah)

(levonorgestrel-releasing intrauterine system)

Read this Patient Information carefully before you decide if Skyla is right for you. This information does not take the place of talking with your gynecologist or other healthcare provider who specializes in women's health. If you have any questions about Skyla, ask your healthcare provider. You should also learn about other birth control methods to choose the one that is best for you.

Skyla does not protect against HIV infection (AIDS) and other sexually transmitted infections (STIs).

What is Skyla?

- Skyla is a hormone-releasing system placed in your uterus by your healthcare provider to prevent pregnancy for up to 3 years.
- Skyla can be removed by your healthcare provider at any time.
- Skyla can be used whether or not you have given birth to a child.

Skyla is a small, flexible plastic T-shaped system that slowly releases a progestin hormone called levonorgestrel (LNG) that is often used in birth control pills. Because Skyla releases LNG into your uterus, only small amounts of the hormone enter your blood. Skyla does not contain estrogen.

Two thin threads are attached to the stem (lower end) of Skyla. The threads are the only part of Skyla you can feel when Skyla is in your uterus; however, unlike a tampon string, the threads do not extend outside your body.

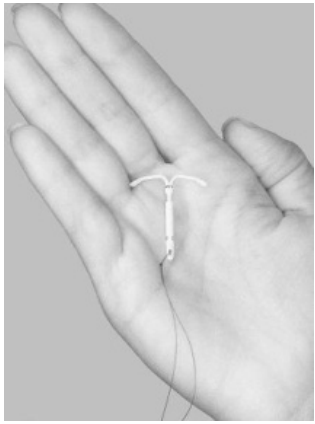

Skyla is small

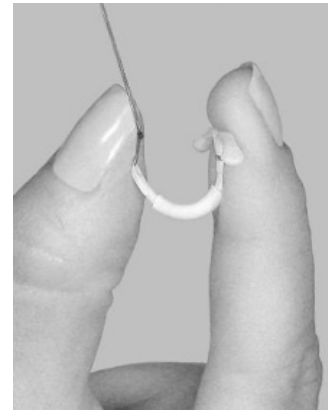

and flexible

What if I need birth control for more than 3 years?

Skyla must be removed after 3 years. Your healthcare provider can place a new Skyla during the same office visit if you choose to continue using Skyla.

What if I want to stop using Skyla?

Skyla is intended for use up to 3 years, but you can stop using Skyla at any time by asking your healthcare provider to remove it. You could become pregnant as soon as Skyla is removed, so you should use another method of birth control if you do not want to become pregnant. Talk to your healthcare provider about the best birth control methods for you, because your new method may need to be started 7 days before Skyla is removed to prevent pregnancy.

What if I change my mind about birth control and want to become pregnant in less than 3 years?

Your healthcare provider can remove Skyla at any time. You may become pregnant as soon as Skyla is removed. About 3 out of 4 women who want to become pregnant will become pregnant sometime in the first year after Skyla is removed.

How does Skyla work?

Skyla may work in several ways including thickening cervical mucus, inhibiting sperm movement, reducing sperm survival, and thinning the lining of your uterus. It is not known exactly how these actions work together to prevent pregnancy.

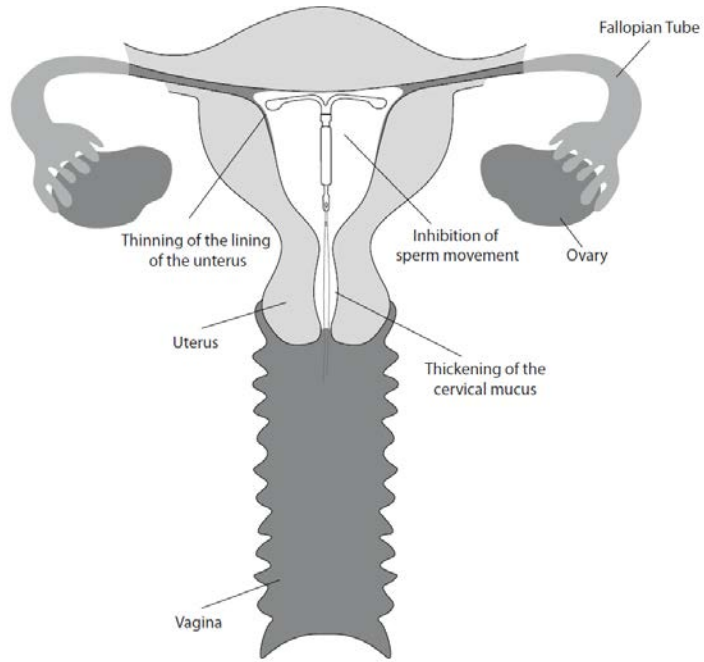

How well does Skyla work for contraception?

The following chart shows the chance of getting pregnant for women who use different methods of birth control. Each box on the chart contains a list of birth control methods that are similar in effectiveness. The most effective methods are at the top of the chart. The box on the bottom of the chart shows the chance of getting pregnant for women who do not use birth control and are trying to get pregnant.

Skyla, an intrauterine device (IUD), also known as an intrauterine system (IUS), is in the box at the top of the chart.

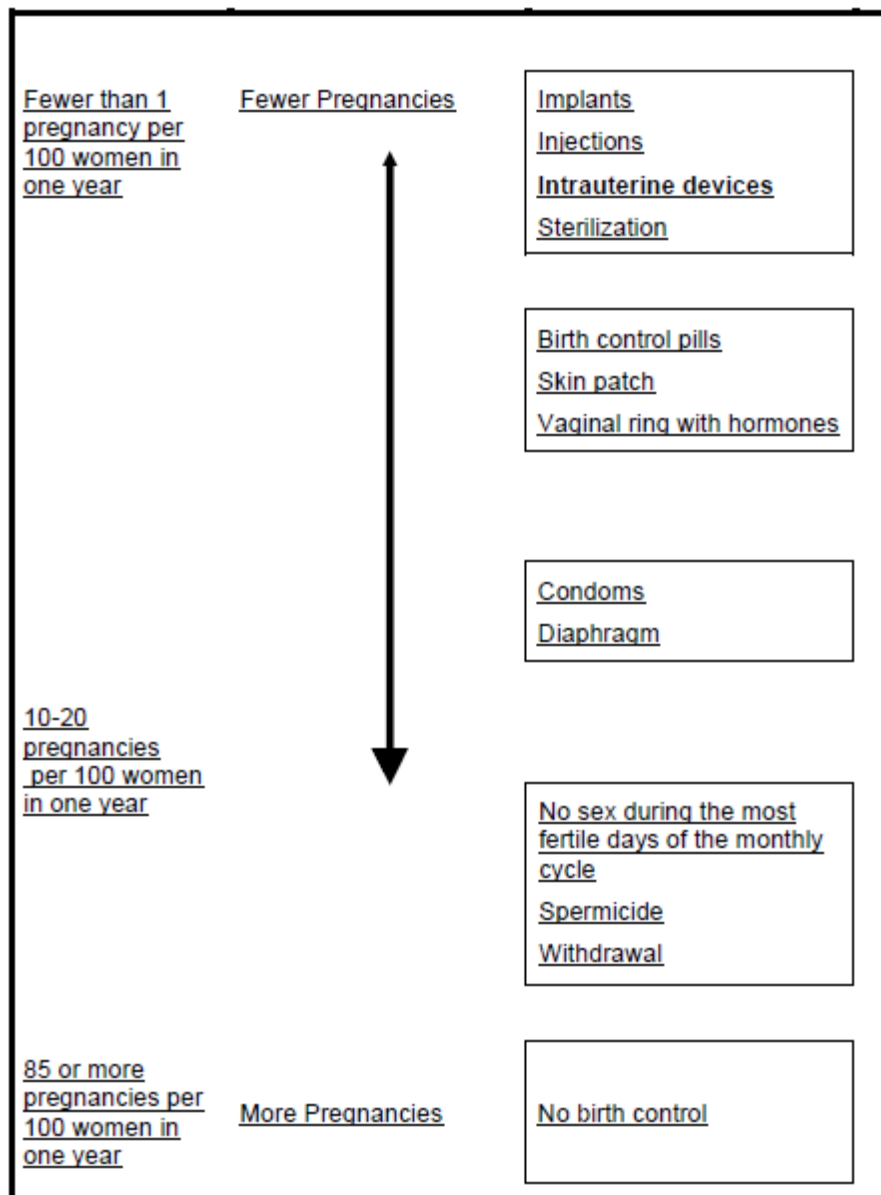

Who might use Skyla?

You might choose Skyla if you:

- want long-term birth control that provides a low chance of getting pregnant (less than 1 in 100)
- want birth control that works continuously for up to 3 years
- want birth control that is reversible
- want a birth control method that you do not need to take daily
- are willing to use a birth control method that is placed in the uterus
- want birth control that does not contain estrogen

Do not use Skyla if you:

- are or might be pregnant; Skyla cannot be used as an emergency contraceptive
- have a serious pelvic infection called pelvic inflammatory disease (PID) or have had PID in the past unless you have had a normal pregnancy after the infection went away
- have an untreated genital infection now
- have had a serious pelvic infection in the past 3 months after a pregnancy
- can get infections easily. For example, if you:
 - have multiple sexual partners or your partner has multiple sexual partners
 - have problems with your immune system
 - use or abuse intravenous drugs
- have or suspect you might have cancer of the uterus or cervix
- have bleeding from the vagina that has not been explained
- have liver disease or a liver tumor
- have breast cancer or any other cancer that is sensitive to progestin (a female hormone), now or in the past
- have an intrauterine device in your uterus already
- have a condition of the uterus that changes the shape of the uterine cavity, such as large fibroid tumors
- are allergic to levonorgestrel, silicone, polyethylene, silver, silica, barium sulfate or iron oxide

Before having Skyla placed, tell your healthcare provider about all of your medical conditions including if you:

- have any of the conditions listed above
- have had a heart attack
- have had a stroke
- were born with heart disease or have problems with your heart valves
- have problems with blood clotting or take medicine to reduce clotting
- have high blood pressure
- recently had a baby or are breastfeeding
- have severe headaches or migraine headaches

- have AIDS, HIV, or any other sexually transmitted infection

Tell your healthcare provider about all of the medicines you take, including prescription and over-the-counter medicines, vitamins, and herbal supplements.

How is Skyla placed?

Skyla is placed by your healthcare provider during an in-office visit or immediately after giving birth.

First, your healthcare provider will examine your pelvis to find the exact position of your uterus. Your healthcare provider will then clean your vagina and cervix with an antiseptic solution and slide a slim plastic tube containing Skyla through the cervix into your uterus. Your healthcare provider will then remove the plastic tube and leave Skyla in your uterus. Your healthcare provider will cut the threads to the right length.

You may experience pain, bleeding or dizziness during and after placement. If your symptoms do not pass within 30 minutes after placement, Skyla may not have been placed correctly. Your healthcare provider will examine you to see if Skyla needs to be removed or replaced.

Should I check that Skyla is in place?

Yes, you should check that Skyla is in proper position by feeling the removal threads. It is a good habit to do this 1 time a month. Your healthcare provider should teach you how to check that Skyla is in place. First, wash your hands with soap and water. You can check by reaching up to the top of your vagina with clean fingers to feel the removal threads. Do not pull on the threads. If you feel more than just the threads or if you cannot feel the threads, Skyla may not be in the right position and may not prevent pregnancy. Avoid intercourse or use non-hormonal back-up birth control (such as condoms or spermicide) and ask your healthcare provider to check that Skyla is still in the right place.

How soon after placement of Skyla should I return to my healthcare provider?

Call your healthcare provider if you have any questions or concerns (see "When should I call my healthcare provider?"). Otherwise, you should return to your healthcare provider for a follow-up visit 4 to 6 weeks after Skyla is placed to make sure that Skyla is in the right position.

Can I use tampons or menstrual cups with Skyla?

Yes, tampons or menstrual cups may be used with Skyla. Change tampons or menstrual cups with care to avoid pulling the threads of Skyla. If you think you may have pulled Skyla out of place, avoid intercourse or use a non-hormonal back-up birth control (such as condoms or spermicide), and contact your healthcare provider.

What if I become pregnant while using Skyla?

Call your healthcare provider right away if you think you may be pregnant. If possible, also do a urine pregnancy test. If you get pregnant while using Skyla, you may have an ectopic pregnancy. This means that the pregnancy is not in the uterus. Unusual vaginal bleeding or abdominal pain may be a sign of ectopic pregnancy.

Ectopic pregnancy is a medical emergency that often requires surgery. Ectopic pregnancy can cause internal bleeding, infertility, and even death.

There are also risks if you get pregnant while using Skyla and the pregnancy is in the uterus. Severe infection, miscarriage, premature delivery, and even death can occur with pregnancies

that continue with an intrauterine device (IUD). Because of this, your healthcare provider may try to remove Skyla, even though removing it may cause a miscarriage. If Skyla cannot be removed, talk with your healthcare provider about the benefits and risks of continuing the pregnancy and possible effects of the hormone on your unborn baby.

If you continue your pregnancy, see your healthcare provider regularly. Call your healthcare provider right away if you get flu-like symptoms, fever, chills, cramping, pain, bleeding, vaginal discharge, or fluid leaking from your vagina. These may be signs of infection.

How will Skyla change my periods?

For the first 3 to 6 months, your period may become irregular and the number of bleeding days may increase. You may also have frequent spotting or light bleeding. Some women have heavy bleeding during this time. You may also have cramping during the first few weeks. After you have used Skyla for a while, the number of bleeding and spotting days is likely to lessen. For some women, periods will stop altogether. When Skyla is removed, your menstrual periods should return.

Is it safe to breastfeed while using Skyla?

You may use Skyla when you are breastfeeding. Skyla is not likely to affect the quality or amount of your breast milk or the health of your nursing baby. However, isolated cases of decreased milk production have been reported. The risk of Skyla going into the wall of the uterus (becoming embedded) or going through the wall of the uterus is increased if Skyla is inserted while you are breastfeeding.

Will Skyla interfere with sexual intercourse?

You and your partner should not feel Skyla during intercourse. Skyla is placed in the uterus, not in the vagina. Sometimes your partner may feel the threads. If this occurs, or if you or your partner experience pain during sex, talk with your healthcare provider.

Can I have an MRI with Skyla in place?

Skyla can be safely scanned with MRI only under specific conditions. Before you have an MRI, tell your healthcare provider that you have Skyla, an intrauterine device (IUD), in place.

What are the possible side effects of Skyla?

Skyla can cause serious side effects, including:

- **Ectopic pregnancy and intrauterine pregnancy risks.** There are risks if you become pregnant while using Skyla (see “What if I become pregnant while using Skyla?”).
- **Life-threatening infection.** Life-threatening infection can occur within the first few days after Skyla is placed. Call your healthcare provider immediately if you develop severe pain or fever shortly after Skyla is placed.
- **Pelvic inflammatory disease (PID).** Some IUD users get a serious pelvic infection called pelvic inflammatory disease. PID is usually sexually transmitted. You have a higher chance of getting PID if you or your partner has sex with other partners. PID can cause serious problems such as infertility, ectopic pregnancy or pelvic pain that does not go away. PID is usually treated with antibiotics. More serious cases of PID may require surgery including removal of the uterus (hysterectomy). In rare cases, infections that start as PID can even cause death.

Tell your healthcare provider right away if you have any of these signs of PID: long-lasting or heavy bleeding, unusual vaginal discharge, low abdominal (stomach area) pain, painful sex, chills, fever, genital lesions or sores.

- **Perforation.** Skyla may go into the wall of the uterus (become embedded) or go through the wall of the uterus. This is called perforation. If this occurs, Skyla may no longer prevent pregnancy. If perforation occurs, Skyla may move outside the uterus and can cause internal scarring, infection, or damage to other organs, and you may need surgery to have Skyla removed. Excessive pain or vaginal bleeding during placement of Skyla, pain or bleeding that gets worse after placement, or not being able to feel the threads may happen with perforation. The risk of perforation is increased if Skyla is inserted while you are breastfeeding, or if you have recently given birth.
- **Expulsion.** Skyla may come out by itself. This is called expulsion. Expulsion occurs in about 3 out of 100 women. Excessive pain or vaginal bleeding during placement of Skyla, pain or bleeding that gets worse after placement, or not being able to feel the threads may happen with expulsion. You may become pregnant if Skyla comes out. If you think that Skyla has come out, avoid intercourse or use a non-hormonal backup birth control (such as condoms or spermicide) and call your healthcare provider. The risk of expulsion is increased with insertion right after delivery or second-trimester abortion.

Common side effects of Skyla include:

- **Pain, bleeding or dizziness during and after placement.** If these symptoms do not stop 30 minutes after placement, Skyla may not have been placed correctly. Your healthcare provider will examine you to see if Skyla needs to be removed or replaced.
- **Changes in bleeding.** You may have bleeding and spotting between menstrual periods, especially during the first 3–6 months. Sometimes the bleeding is heavier than usual at first. However, the bleeding usually becomes lighter than usual and may be irregular. Call your healthcare provider if the bleeding remains heavier than usual or increases after it has been light for a while.
- **Missed menstrual periods.** About 1 out of 16 women stop having periods after 1 year of Skyla use. If you have any concerns that you may be pregnant while using Skyla, do a urine pregnancy test and call your healthcare provider. If you do not have a period for 6 weeks during Skyla use, call your healthcare provider. When Skyla is removed, your menstrual periods should return.
- **Cysts on the ovary.** About 14 out of 100 women using Skyla develop a cyst on the ovary. These cysts usually disappear on their own in two to three months. However, cysts can cause pain and sometimes cysts will need surgery.

Other common side effects include:

- abdominal or pelvic pain
- acne or greasy skin
- headache or migraine
- inflammation or infection of the outer part of your vagina (vulvovaginitis)
- painful periods

These are not all of the possible side effects with Skyla. For more information, ask your healthcare provider.

Call your doctor for medical advice about side effects. You may report side effects to FDA at 1-800-FDA-1088. You may also report side effects to Bayer Healthcare Pharmaceuticals at 1-888-842-2937.

After Skyla has been placed, when should I call my healthcare provider?

If Skyla is accidentally removed and you had vaginal intercourse within the preceding week, you may be at risk of pregnancy, and you should talk to a healthcare provider.

Call your healthcare provider if you have any concerns about Skyla. Be sure to call if you:

- think you are pregnant
- have pelvic pain, abdominal pain, or pain during sex
- have unusual vaginal discharge or genital sores
- have unexplained fever, flu-like symptoms or chills
- might be exposed to sexually transmitted infections (STIs)
- are concerned that Skyla may have been expelled (came out)
- cannot feel Skyla's threads
- develop very severe or migraine headaches
- have yellowing of the skin or whites of the eyes. These may be signs of liver problems.
- have had a stroke or heart attack
- become HIV positive or your partner becomes HIV positive
- have severe vaginal bleeding or bleeding that lasts a long time or concerns you

General advice about the safe and effective use of Skyla

Medicines are sometimes prescribed for conditions other than those listed in patient information leaflets. If you would like more information, talk with your healthcare provider. You can ask your healthcare provider for information about Skyla that is written for healthcare professionals.

What are the ingredients in Skyla?

Active ingredient: levonorgestrel

Inactive ingredients: silicone, polyethylene, silver, silica, barium sulfate, iron oxide

Manufactured for:

Bayer HealthCare Pharmaceuticals Inc.
Whippany, NJ 07981

© 2013, Bayer HealthCare Pharmaceuticals Inc.
All rights reserved.

For more information, go to www.skyla-us.com or call 1-888-842-2937.