

## HIGHLIGHTS OF PRESCRIBING INFORMATION

These highlights do not include all the information needed to use ABILIFY ASIMTUFII safely and effectively. See full prescribing information for ABILIFY ASIMTUFII.

**ABILIFY ASIMTUFII® (aripiprazole) extended-release injectable suspension, for intramuscular use**

Initial U.S. Approval: 2002

### WARNING: INCREASED MORTALITY IN ELDERLY PATIENTS WITH DEMENTIA-RELATED PSYCHOSIS

See full prescribing information for complete boxed warning.

- Elderly patients with dementia-related psychosis treated with antipsychotic drugs are at an increased risk of death (5.1)
- ABILIFY ASIMTUFII is not approved for the treatment of patients with dementia-related psychosis (5.1)

### INDICATIONS AND USAGE

ABILIFY ASIMTUFII is an atypical antipsychotic indicated:

- for the treatment of schizophrenia in adults (1)
- as maintenance monotherapy treatment of bipolar I disorder in adults (1)

### DOSAGE AND ADMINISTRATION

- For patients naïve to aripiprazole, establish tolerability with oral aripiprazole prior to initiating treatment with ABILIFY ASIMTUFII (2.1)
- Administer by intramuscular injection in the gluteal muscle by a healthcare professional. Do not administer by any other route (2.1)
- Recommended dosage is 960 mg administered once every 2 months as a single injection. Dose can be reduced to 720 mg in patients with adverse reactions (2.2)
- Missed doses: Dosage adjustment may be required (2.3)
- Known CYP2D6 poor metabolizers: Recommended dosage is 720 mg administered once every 2 months as a single injection (2.4)
- See Full Prescribing Information for important preparation and administration information (2.5)

### DOSAGE FORMS AND STRENGTHS

Extended-release injectable suspension: 960 mg/3.2 mL and 720 mg/2.4 mL single-dose pre-filled syringes (3)

### CONTRAINDICATIONS

Known hypersensitivity to aripiprazole, or to any excipients of ABILIFY ASIMTUFII (4)

### WARNINGS AND PRECAUTIONS

- Cerebrovascular Adverse Reactions in Elderly Patients with Dementia-Related Psychosis: Increased incidence of cerebrovascular adverse reactions (e.g., stroke, transient ischemic attack, including fatalities) (5.2)

- Neuroleptic Malignant Syndrome: Manage with immediate discontinuation and close monitoring (5.3)
- Tardive Dyskinesia: Discontinue if clinically appropriate (5.4)
- Metabolic Changes: Monitor for hyperglycemia/diabetes mellitus, dyslipidemia, and weight gain (5.5)
- Pathological Gambling and Other Compulsive Behaviors: Consider dose reduction or discontinuation (5.6)
- Orthostatic Hypotension and Syncope: Monitor heart rate and blood pressure and caution in patients with known cardiovascular or cerebrovascular disease, and risk of dehydration or syncope (5.7)
- Leukopenia, Neutropenia, and Agranulocytosis: Perform complete blood counts (CBC) in patients with history of clinically significant low white blood cell count (WBC) or a history of leukopenia or neutropenia. Consider discontinuing ABILIFY ASIMTUFII if clinically significant decline in WBC in the absence of other causative factors (5.9)
- Seizures: Use cautiously in patients with a history of seizures or with conditions that lower the seizure threshold (5.10)
- Potential for Cognitive and Motor Impairment: Use caution when operating machinery (5.11)

### ADVERSE REACTIONS

Most commonly observed adverse reactions (incidence  $\geq 5\%$  and at least twice the rate of placebo) were increased weight, akathisia, injection site pain, and sedation (6.1)

To report SUSPECTED ADVERSE REACTIONS, contact Otsuka America Pharmaceutical, Inc. at 1-800-438-9927 or FDA at 1-800-FDA-1088 or [www.fda.gov/medwatch](http://www.fda.gov/medwatch).

### DRUG INTERACTIONS

Dosage adjustments for patients taking CYP2D6 inhibitors, CYP3A4 inhibitors, or CYP3A4 inducers for greater than 14 days (7.1):

Factors	Dosage Recommendation
CYP2D6 Poor Metabolizers taking concomitant CYP3A4 inhibitors	Avoid use
Patients taking strong CYP2D6 or CYP3A4 inhibitors	720 mg
Patients taking CYP2D6 and CYP3A4 inhibitors	Avoid use
Patients taking CYP3A4 inducers	Avoid use

### USE IN SPECIFIC POPULATIONS

*Pregnancy:* May cause extrapyramidal and/or withdrawal symptoms in neonates with third trimester exposure (8.1)

See 17 for PATIENT COUNSELING INFORMATION and [Medication Guide](#).

Revised: 4/2023

## FULL PRESCRIBING INFORMATION: CONTENTS\*

### WARNING: INCREASED MORTALITY IN ELDERLY PATIENTS WITH DEMENTIA-RELATED PSYCHOSIS

- 1 [INDICATIONS AND USAGE](#)
- 2 [DOSAGE AND ADMINISTRATION](#)
  - 2.1 Important Administration Information
  - 2.2 Recommended Dosage for ABILIFY ASIMTUFII
  - 2.3 Missed Doses
  - 2.4 Dosage Recommendations for Cytochrome P450 Considerations
  - 2.5 Preparation and Administration Instructions
- 3 [DOSAGE FORMS AND STRENGTHS](#)
- 4 [CONTRAINDICATIONS](#)
- 5 [WARNINGS AND PRECAUTIONS](#)
  - 5.1 Increased Mortality in Elderly Patients with Dementia-Related Psychosis
  - 5.2 Cerebrovascular Adverse Reactions, Including Stroke in Elderly Patients with Dementia-Related Psychosis
  - 5.3 Neuroleptic Malignant Syndrome
  - 5.4 Tardive Dyskinesia
  - 5.5 Metabolic Changes
  - 5.6 Pathological Gambling and Other Compulsive Behaviors
  - 5.7 Orthostatic Hypotension and Syncope
  - 5.8 Falls
  - 5.9 Leukopenia, Neutropenia, and Agranulocytosis
  - 5.10 Seizures
  - 5.11 Potential for Cognitive and Motor Impairment
  - 5.12 Body Temperature Regulation
  - 5.13 Dysphagia
- 6 [ADVERSE REACTIONS](#)
  - 6.1 Clinical Trials Experience
  - 6.2 Postmarketing Experience
- 7 [DRUG INTERACTIONS](#)
  - 7.1 Drugs Having Clinically Important Interactions with ABILIFY ASIMTUFII
  - 7.2 Drugs Having No Clinically Important Interactions with ABILIFY ASIMTUFII
- 8 [USE IN SPECIFIC POPULATIONS](#)
  - 8.1 Pregnancy
  - 8.2 Lactation
  - 8.4 Pediatric Use
  - 8.5 Geriatric Use
  - 8.6 CYP2D6 Poor Metabolizers
  - 8.7 Renal Impairment
  - 8.8 Hepatic Impairment
- 10 [OVERDOSAGE](#)
- 11 [DESCRIPTION](#)
- 12 [CLINICAL PHARMACOLOGY](#)
  - 12.1 Mechanism of Action
  - 12.2 Pharmacodynamics
  - 12.3 Pharmacokinetics
- 13 [NONCLINICAL TOXICOLOGY](#)
  - 13.1 Carcinogenesis, Mutagenesis, Impairment of Fertility
  - 13.2 Animal Toxicology and/or Pharmacology
- 14 [CLINICAL STUDIES](#)
- 16 [HOW SUPPLIED/STORAGE AND HANDLING](#)
- 17 [PATIENT COUNSELING INFORMATION](#)

\*Sections or subsections omitted from the full prescribing information are not listed.

## FULL PRESCRIBING INFORMATION

### **WARNING: INCREASED MORTALITY IN ELDERLY PATIENTS WITH DEMENTIA-RELATED PSYCHOSIS**

**Elderly patients with dementia-related psychosis treated with antipsychotic drugs are at an increased risk of death. ABILIFY ASIMTUFII is not approved for the treatment of patients with dementia-related psychosis [see Warnings and Precautions (5.1)].**

## 1 INDICATIONS AND USAGE

ABILIFY ASIMTUFII is indicated:

- for the treatment of schizophrenia in adults
- for maintenance monotherapy treatment of bipolar I disorder in adults

## 2 DOSAGE AND ADMINISTRATION

### 2.1 Important Administration Information

For patients who have never taken aripiprazole, establish tolerability with oral aripiprazole prior to initiating treatment with ABILIFY ASIMTUFII. Due to the half-life of oral aripiprazole, it may take up to 2 weeks to fully assess tolerability.

ABILIFY ASIMTUFII must be administered as an intramuscular gluteal injection by a healthcare professional. Do not administer by any other route.

For detailed preparation and administration instructions, see *Dosage and Administration (2.5)*.

### 2.2 Recommended Dosage for ABILIFY ASIMTUFII

The recommended dosage of ABILIFY ASIMTUFII is 960 mg, administered once every 2 months (56 days after previous injection).

#### Patients Receiving Oral Antipsychotics

When ABILIFY ASIMTUFII injection is initiated in patients receiving oral aripiprazole, administer the first dose of ABILIFY ASIMTUFII along with oral aripiprazole (10 mg to 20 mg) for 14 consecutive days.

For patients already stable on another oral antipsychotic (and known to tolerate aripiprazole), administer the first ABILIFY ASIMTUFII injection along with the oral antipsychotic for 14 consecutive days.

#### Patients Receiving Abilify Maintena

For patients receiving Abilify Maintena (once monthly dosing), administer ABILIFY ASIMTUFII 960 mg (once every 2 month dosing) in place of the next scheduled injection of the Abilify Maintena. The first ABILIFY ASIMTUFII injection may be administered in place of the second, or later injection of Abilify Maintena.

If there are adverse reactions with the ABILIFY ASIMTUFII 960 mg dosage, the dosage may be reduced to 720 mg once every 2 months.

Patients may be given the ABILIFY ASIMTUFII injection up to 2 weeks before or 2 weeks after the 2-month scheduled timepoint.

### 2.3 Missed Doses

If more than 8 weeks and less than 14 weeks have elapsed since the last injection, administer the next dose of ABILIFY ASIMTUFII as soon as possible. The once every 2 month schedule should be resumed.

If more than 14 weeks have elapsed since the last injection, restart concomitant oral aripiprazole for 14 days with the next administered injection of ABILIFY ASIMTUFII.

### 2.4 Dosage Recommendations for Cytochrome P450 Considerations

Dosage adjustments for patients who are CYP2D6 poor metabolizers and/or in patients taking concomitant CYP3A4 inhibitors or CYP2D6 inhibitors for more than 14 days are described in Table 1.

If the CYP3A4 inhibitor or CYP2D6 inhibitor is withdrawn, the dosage of ABILIFY ASIMTUFII may need to be increased to the previous dose.

Dosage adjustments are not recommended for patients with concomitant use of CYP3A4 inhibitors, CYP2D6 inhibitors or CYP3A4 inducers for less than 14 days.

**Table 1: Dosage Recommendations for ABILIFY ASIMTUFII in Patients Who are Known CYP2D6 Poor Metabolizers, Patients Taking Concomitant CYP2D6 Inhibitors, 3A4 Inhibitors, or CYP3A4 Inducers for Greater than 14 days**

Factors	Dosage Recommendation
<b>CYP2D6 Poor Metabolizers</b>	
Known CYP2D6 Poor Metabolizers	720 mg once every 2 months
Known CYP2D6 Poor Metabolizers taking concomitant CYP3A4 inhibitors	Avoid use
<b>Patients Taking 960 mg of ABILIFY ASIMTUFII</b>	
Concomitant use of ABILIFY ASIMTUFII with Strong CYP2D6 inhibitors	720 mg once every 2 months
Concomitant use of ABILIFY ASIMTUFII with Strong CYP3A4 inhibitors	720 mg once every 2 months
Concomitant use of ABILIFY ASIMTUFII with Strong CYP2D6 <b>and</b> Strong CYP3A4 inhibitors	Avoid use
Concomitant use of ABILIFY ASIMTUFII with CYP3A4 inducers	Avoid use

### 2.5 Preparation and Administration Instructions

- Read the complete instructions for preparation and administration below and consider referring to the separate Healthcare Provider “Instructions for Use” for additional preparation and administration considerations.
- To be prepared and administered by a healthcare professional only.
- For gluteal intramuscular injection only. Do not administer by any other route.

- Prior to administration, visually inspect ABILIFY ASIMTUFII pre-filled syringe for particulate matter and discoloration. The suspension should appear to be a uniform, homogeneous suspension that is opaque and milky-white in color. Do not use ABILIFY ASIMTUFII pre-filled syringe if the suspension is discolored, or particulate matter is present
- Each kit contains one sterile pre-filled syringe containing ABILIFY ASIMTUFII 720 mg or 960 mg and two safety needles:
  - One sterile 1 ½ inch, 22 gauge needle (in black packaging)
  - One sterile 2 inch, 21 gauge needle (in green packaging)

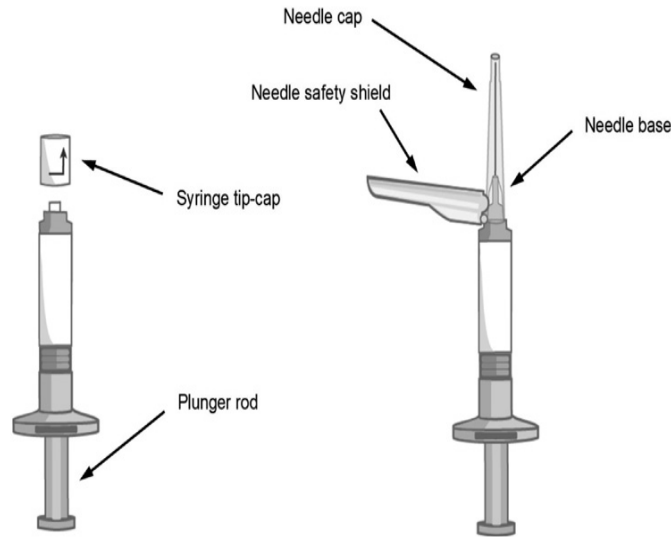

### Preparation Prior to Administration

- Remove the ABILIFY ASIMTUFII pre-filled syringe from the package.
- Tap the syringe on your hand at least 10 (ten) times (Figure 1).
- After tapping, shake the syringe vigorously for at least 10 (ten) seconds, until the medication is uniform (Figure 2).

**Figure 1**



**Figure 2**

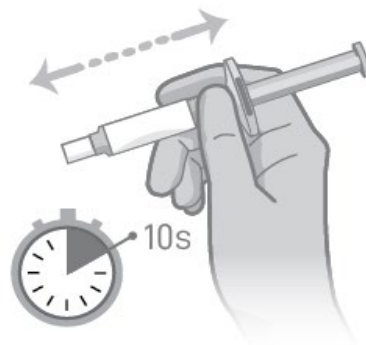

### Select the appropriate needle

Needle selection is determined by patient body type.

#### **For gluteal intramuscular administration only.**

- For non-obese patients - 22-gauge, 1.5-inch (38 mm) safety needle with needle protection device (needle in black packaging)
- For obese patients - 21-gauge, 2-inch (51 mm) safety needle with needle protection device (needle in green packaging)

### Attach the needle

- Twist and pull off the pre-filled syringe tip-cap (Figure 3).
- While holding the base of the needle, ensure the needle is firmly seated on the safety device with a push. Gently twist clockwise until SECURELY fitted (Figure 3).

**Figure 3**

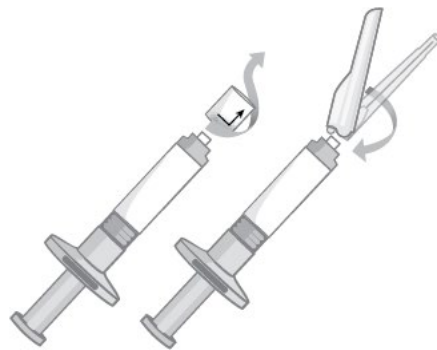

### Expel Air

- When you are ready to administer the injection of ABILIFY ASIMTUFII, hold the pre-filled syringe upright and remove the needle-cap straight up (Figure 4). Do not twist the needle-cap, as this may loosen the needle from the syringe.

**Figure 4**

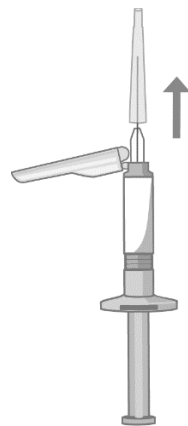

- Slowly advance the plunger rod upward to expel the air and until the suspension fills needle base (Figure 5).

**Figure 5**



Inject the dose

- Slowly inject the entire contents of the pre-filled syringe intramuscularly into the gluteal muscle of the patient (Figure 6).

**Do not administer by any other route.**

Do not massage the injection site.

**Figure 6**

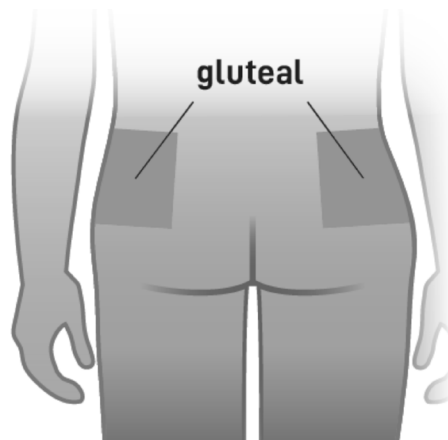

Disposal Procedure

- After the injection, press the safety shield on a hard surface to cover and lock shield over the needle (Figures 7 and 8)

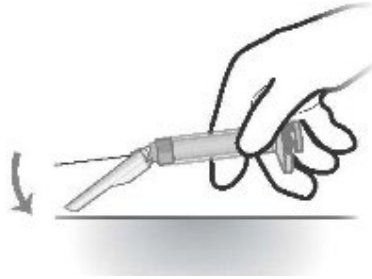
**Figure 7****Figure 8**

- Immediately discard used syringe and the unused needle in an approved sharps container.
- The unused needle should not be saved for future use.

### 3 DOSAGE FORMS AND STRENGTHS

Extended-release injectable suspension: sterile, white to off-white, aqueous suspension in a single-dose, pre-filled syringe.

**Table 2: ABILIFY ASIMTUFII Presentations**

Dose Strength	Volume	Label Color	Syringe Tip Wrap
720 mg	2.4 mL	Light Blue	Aqua
960 mg	3.2 mL	Pink	Light Blue

### 4 CONTRAINDICATIONS

ABILIFY ASIMTUFII is contraindicated in patients with a known hypersensitivity to aripiprazole, or any of the excipients. Hypersensitivity reactions ranging from pruritus/urticaria to anaphylaxis have been reported in patients receiving aripiprazole [see *Adverse Reactions* (6.1)].

### 5 WARNINGS AND PRECAUTIONS

#### 5.1 Increased Mortality in Elderly Patients with Dementia-Related Psychosis

Elderly patients with dementia-related psychosis treated with antipsychotic drugs are at an increased risk of death. Analyses of 17 placebo-controlled trials (modal duration of 10 weeks), largely in patients taking atypical antipsychotic drugs, revealed a risk of death in drug-treated patients of between 1.6 to 1.7 times the risk of death in placebo-treated patients. Over the course of a typical 10-week controlled trial, the rate of death in drug-treated patients was about 4.5%, compared to a rate of about 2.6% in the placebo group.

Although the causes of death were varied, most of the deaths appeared to be either cardiovascular (e.g., heart failure, sudden death) or infectious (e.g., pneumonia) in nature. Observational studies suggest that, similar to atypical antipsychotic drugs, treatment with conventional antipsychotic drugs may increase mortality. The extent to which the findings of increased mortality in observational studies may be attributed to the antipsychotic drug as opposed to some characteristic(s) of the patients is not clear.

ABILIFY ASIMTUFII is not approved for the treatment of patients with dementia-related psychosis [see *Boxed Warning* and *Warnings and Precautions* (5.2)].



## 5.2 Cerebrovascular Adverse Reactions, Including Stroke in Elderly Patients with Dementia-Related Psychosis

In placebo-controlled clinical studies (two flexible-dose and one fixed-dose study) of dementia-related psychosis, there was an increased incidence of cerebrovascular adverse reactions (e.g., stroke, transient ischemic attack), including fatalities, in oral aripiprazole-treated patients (mean age: 84 years; range: 78 to 88 years). In the fixed-dose study, there was a statistically significant dose response relationship for cerebrovascular adverse reactions in patients treated with oral aripiprazole. ABILIFY ASIMTUFII is not approved for the treatment of patients with dementia-related psychosis [see *Warnings and Precautions* (5.1)].

## 5.3 Neuroleptic Malignant Syndrome

Neuroleptic Malignant Syndrome (NMS), a potentially fatal symptom complex has been reported with antipsychotic drugs, including aripiprazole. Rare cases of NMS have been reported during aripiprazole treatment in the global clinical database.

Clinical manifestations of NMS are hyperpyrexia, muscle rigidity, altered mental status, and evidence of autonomic instability (irregular pulse or blood pressure, tachycardia, diaphoresis, and cardiac dysrhythmia). Additional signs may include elevated creatine phosphokinase, myoglobinuria (rhabdomyolysis) and acute renal failure.

If NMS is suspected, immediately discontinue ABILIFY ASIMTUFII and provide symptomatic treatment and monitoring.

## 5.4 Tardive Dyskinesia

Tardive dyskinesia, a syndrome of potentially irreversible, involuntary, dyskinetic movements may develop in patients treated with antipsychotic drugs. Although the prevalence of the syndrome appears to be highest among the elderly, especially elderly women, it is impossible to predict which patients will develop the syndrome. Whether antipsychotic drug products differ in their potential to cause tardive dyskinesia is unknown.

The risk of developing tardive dyskinesia and the likelihood that it will become irreversible appear to increase as the duration of treatment and the total cumulative dose increases. The syndrome can develop, after relatively brief treatment periods at low doses. It may also occur after discontinuation of treatment.

Tardive dyskinesia may remit, partially or completely, if antipsychotic treatment is discontinued. Antipsychotic treatment itself may suppress (or partially suppress) the signs and symptoms of the syndrome and may mask the underlying process. The effect of symptomatic suppression on the long-term course of the syndrome is unknown.

Given these considerations, ABILIFY ASIMTUFII should be prescribed in a manner that is most likely to minimize the occurrence of tardive dyskinesia. Chronic antipsychotic treatment should generally be reserved for patients who suffer from a chronic illness that 1) is known to respond to antipsychotic drugs and 2) for whom alternative, equally effective, but potentially less harmful treatments are not available or appropriate. In patients who do require chronic treatment, the smallest dose and the shortest duration of treatment producing a satisfactory clinical response should be sought. The need for continued treatment should be reassessed periodically.

If signs and symptoms of tardive dyskinesia appear in a patient treated with ABILIFY ASIMTUFII, drug discontinuation should be considered. However, some patients may require treatment with ABILIFY ASIMTUFII despite the presence of the syndrome.

## 5.5 Metabolic Changes

Atypical antipsychotic drugs have been associated with metabolic changes including hyperglycemia/diabetes mellitus, dyslipidemia, and body weight gain. While all drugs in the class have been shown to produce some metabolic changes, each drug has its own specific risk profile.

### Hyperglycemia/Diabetes Mellitus

Hyperglycemia, in some cases extreme and associated with diabetic ketoacidosis, hyperosmolar coma, or death, have been reported in patients treated with atypical antipsychotics. There have been reports of hyperglycemia in patients treated with aripiprazole [see *Adverse Reactions* (6.1)]. Assessment of the relationship between atypical antipsychotic use and glucose abnormalities is complicated by the possibility of an increased background risk of diabetes mellitus in patients with schizophrenia and the increasing incidence of diabetes mellitus in the general population. Given these confounders, the relationship between atypical antipsychotic use and hyperglycemia-related adverse reactions is not completely understood. However, epidemiological studies suggest an increased risk of hyperglycemia-related adverse reactions in patients treated with the atypical antipsychotics.

Patients with an established diagnosis of diabetes mellitus who are started on atypical antipsychotics, including ABILIFY ASIMTUFII, should be monitored regularly for worsening of glucose control. Patients with risk factors for diabetes mellitus (e.g., obesity, family history of diabetes), who are starting treatment with atypical antipsychotics should undergo fasting blood glucose testing at the beginning of treatment and periodically during treatment. Any patient treated with atypical antipsychotics, including ABILIFY ASIMTUFII, should be monitored for symptoms of hyperglycemia including polydipsia, polyuria, polyphagia, and weakness. Patients who develop symptoms of hyperglycemia during treatment with atypical antipsychotics, including ABILIFY ASIMTUFII, should undergo fasting blood glucose testing. In some cases, hyperglycemia has resolved when the atypical antipsychotic was discontinued; however, some patients required continuation of anti-diabetic treatment despite discontinuation of the atypical antipsychotic drug.

In a short-term, placebo-controlled randomized trial in adults with schizophrenia, the mean change in fasting glucose was +9.8 mg/dL (N=88) in the Abilify Maintena-treated patients (once monthly dosing) and +0.7 mg/dL (N=59) in the placebo-treated patients. Table 3 shows the proportion of Abilify Maintena-treated patients with normal and borderline fasting glucose at baseline and their changes in fasting glucose measurements.

**Table 3: Proportion of Patients with Potential Clinically Relevant Changes in Fasting Glucose from a 12-Week Placebo-Controlled Monotherapy Trial with Abilify Maintena in Adult Patients with Schizophrenia**

	<b>Category Change (at least once) from Baseline</b>	<b>Treatment Arm</b>	<b>n/N*</b>	<b>%</b>
<b>Fasting Glucose</b>	Normal to High (<100 mg/dL to ≥126 mg/dL)	Abilify Maintena	7/88	8.0
		Placebo	0/75	0.0
	Borderline to High (≥100 mg/dL and <126 mg/dL to ≥126 mg/dL)	Abilify Maintena	1/33	3.0
		Placebo	3/33	9.1

\*N = the total number of subjects who had a measurement at baseline and at least one post-baseline result. n = the number of subjects with a potentially clinically relevant shift.

During a 52-week, open-label bipolar I disorder study in those patients who initiated Abilify Maintena treatment, 1.1% with normal baseline fasting glucose experienced a shift to high while receiving Abilify Maintena and 9.8% with borderline fasting glucose experienced a shift to high. Combined, 2.9% of these patients with normal or borderline fasting glucose experienced shifts to high fasting glucose during this trial.

### Dyslipidemia

Undesirable alterations in lipids have been observed in patients treated with atypical antipsychotics.

Table 4 shows the proportion of adult patients from one short-term, placebo-controlled randomized trial in adults with schizophrenia taking Abilify Maintena (once monthly dosing), with changes in total cholesterol, fasting triglycerides, fasting LDL cholesterol and HDL cholesterol.

**Table 4: Proportion of Patients with Potential Clinically Relevant Changes in Blood Lipid Parameters From a 12-Week Placebo-Controlled Monotherapy Trial with Abilify Maintena in Adults with Schizophrenia**

	<b>Treatment Arm</b>	<b>n/N*</b>	<b>%</b>
<b>Total Cholesterol</b> Normal to High (<200 mg/dL to ≥240 mg/dL)	Abilify Maintena	3/83	3.6
	Placebo	2/73	2.7
Borderline to High (200~<240 mg/dL to ≥240 mg/dL)	Abilify Maintena	6/27	22.2
	Placebo	2/19	10.5
Any increase (≥40 mg/dL)	Abilify Maintena	15/122	12.3
	Placebo	6/110	5.5
<b>Fasting Triglycerides</b> Normal to High (<150 mg/dL to ≥200 mg/dL)	Abilify Maintena	7/98	7.1
	Placebo	4/78	5.1
Borderline to High (150~<200 mg/dL to ≥200 mg/dL)	Abilify Maintena	3/11	27.3
	Placebo	4/15	26.7
Any increase (≥50 mg/dL)	Abilify Maintena	24/122	19.7
	Placebo	20/110	18.2
<b>Fasting LDL Cholesterol</b> Normal to High (<100 mg/dL to ≥160 mg/dL)	Abilify Maintena	1/59	1.7
	Placebo	1/51	2.0
Borderline to High (100~<160 mg/dL to ≥160 mg/dL)	Abilify Maintena	5/52	9.6
	Placebo	1/41	2.4
Any increase (≥30 mg/dL)	Abilify Maintena	17/120	14.2
	Placebo	9/103	8.7
<b>HDL Cholesterol</b> Normal to Low (≥40 mg/dL to <40 mg/dL)	Abilify Maintena	14/104	13.5
	Placebo	11/87	12.6
	Abilify Maintena	7/122	5.7

	Treatment Arm	n/N*	%
Any decrease (≥20 mg/dL)	Placebo	12/110	10.9

\*N = the total number of subjects who had a measurement at baseline and at least one post-baseline result. n = the number of subjects with a potentially clinically relevant shift.

During a 52-week, open-label bipolar I disorder study in those patients who initiated Abilify Maintena, shifts from baseline in fasting cholesterol from normal to high were reported in 2.1% (total cholesterol) and 2.2% (LDL cholesterol) and shifts from baseline from normal to low were reported in 8.5% (HDL cholesterol). Of these patients with normal baseline triglycerides, 3.6% experienced shifts to high, and 0.0% experienced shifts to very high. Combined, 1.0% of these patients with normal or borderline fasting triglycerides experienced shifts to very high fasting triglycerides during this trial.

### Weight Gain

Weight gain has been observed with atypical antipsychotic use. Clinical monitoring of weight is recommended.

In one short-term, placebo-controlled trial in adult patients with schizophrenia with Abilify Maintena (once monthly dosing), the mean change in body weight at Week 12 was +3.5 kg (N=99) in the Abilify Maintena-treated patients and +0.8 kg (N=66) in the placebo-treated patients.

Table 5 shows the percentage of adult patients with schizophrenia with weight gain ≥7% of body weight in a short-term, placebo-controlled trial with Abilify Maintena.

**Table 5: Percentage of Patients From a 12-Week Placebo-Controlled Trial with Abilify Maintena in Adult Patients with Schizophrenia with Weight Gain ≥7% of Body Weight**

	Treatment Arm	N*	Patients n (%)
<b>Weight gain ≥7% of body weight</b>	Abilify Maintena	144	31 (21.5)
	Placebo	141	12 (8.5)

\*N = the total number of subjects who had a measurement at baseline and at least one post-baseline result.

During a 52-week, open-label bipolar I disorder study in those patients who initiated Abilify Maintena, 1.8% discontinued Abilify Maintena treatment due to weight increase. Abilify Maintena was associated with mean increase from baseline in weight of 1.0 kg at Week 52. In this trial, 21.4% of these patients demonstrated ≥7% increase in body weight and 15.4% demonstrated a ≥7% decrease in body weight.

## **5.6 Pathological Gambling and Other Compulsive Behaviors**

Post-marketing case reports suggest that patients can experience intense urges, particularly for gambling, and the inability to control these urges while taking aripiprazole. Other compulsive urges, reported less frequently, include: sexual urges, shopping, eating or binge eating, and other impulsive or compulsive behaviors. Because patients may not recognize these behaviors as abnormal, it is important for prescribers to ask patients or their caregivers specifically about the development of new or intense gambling urges, compulsive sexual urges, compulsive shopping, binge or compulsive eating, or other urges while being treated with aripiprazole. It should be noted that impulse-control symptoms can be associated with the underlying disorder.

In some cases, although not all, urges were reported to have stopped when the dose was reduced, or the medication was discontinued. Compulsive behaviors may result in harm to the patient and others if not recognized. Consider dose reduction or stopping the medication if a patient develops such urges.

## 5.7 Orthostatic Hypotension and Syncope

ABILIFY ASIMTUFII may cause orthostatic hypotension, perhaps due to its  $\alpha$ 1-adrenergic receptor antagonism. Associated reactions related to orthostatic hypotension can include dizziness, tachycardia, and in some patients, syncope. In the short-term, placebo-controlled trial in adults with schizophrenia, the adverse reaction of presyncope was reported in 1/167 (0.6%) of patients treated with Abilify Maintena (once monthly dosing), while syncope and orthostatic hypotension were each reported in 1/172 (0.6%) of patients treated with placebo. During the stabilization phase of the randomized-withdrawal (maintenance) study in adult patients with schizophrenia, orthostasis-related adverse events were reported in 4/576 (0.7%) of patients treated with Abilify Maintena, including abnormal orthostatic blood pressure (1/576, 0.2%), postural dizziness (1/576, 0.2%), presyncope (1/576, 0.2%) and orthostatic hypotension (1/576, 0.2%).

In the short-term placebo-controlled trial of Abilify Maintena in adults with schizophrenia, there were no patients in either treatment group with a significant orthostatic change in blood pressure (defined as a decrease in systolic blood pressure  $\geq$ 20 mmHg accompanied by an increase in heart rate  $\geq$ 25 bpm when comparing standing to supine values). During the stabilization phase of the randomized-withdrawal (maintenance) study in adult patients with schizophrenia, the incidence of significant orthostatic change in blood pressure was 0.2% (1/575).

Use ABILIFY ASIMTUFII with caution in patients with known cardiovascular disease (heart failure, history of myocardial infarction or ischemia, conduction abnormalities), cerebrovascular disease, or conditions that predispose the patient to hypotension (e.g., dehydration, hypovolemia, and treatment with antihypertensive medications). Monitoring of orthostatic vital signs should be considered in patients who are vulnerable to hypotension.

## 5.8 Falls

Antipsychotics, including ABILIFY ASIMTUFII, may cause somnolence, postural hypotension, motor and sensory instability which may lead to falls and, consequently, fractures or other fall-related injuries. For patients with diseases, conditions, or medications that could exacerbate these effects, complete fall risk assessments when initiating antipsychotic treatment and recurrently for patients on long-term antipsychotic therapy.

## 5.9 Leukopenia, Neutropenia, and Agranulocytosis

In clinical trials and post-marketing experience, leukopenia and neutropenia have been reported temporally related to antipsychotic agents, including aripiprazole. Agranulocytosis has also been reported [see *Adverse Reactions* (6.1)].

Possible risk factors for leukopenia/neutropenia include pre-existing low white blood cell count (WBC) absolute neutrophil count (ANC) and a history of drug-induced leukopenia/neutropenia. In patients with a history of a clinically significant low WBC/ANC or drug-induced leukopenia/neutropenia, perform a complete blood count (CBC) frequently during the first few months of therapy. In such patients, consider discontinuation of ABILIFY ASIMTUFII at the first sign of a clinically significant decline in WBC in the absence of other causative factors.

Monitor patients with clinically significant neutropenia for fever or other symptoms or signs of infection and treat promptly if such symptoms or signs occur. Discontinue ABILIFY ASIMTUFII in patients with severe neutropenia (ANC<1000/mm<sup>3</sup>) and follow their WBC counts until recovery.

### 5.10 Seizures

As with other antipsychotic drugs, use ABILIFY ASIMTUFII cautiously in patients with a history of seizures or other conditions that potentially lower the seizure threshold. Conditions that lower the seizure threshold may be more prevalent in a population of 65 years or older.

### 5.11 Potential for Cognitive and Motor Impairment

ABILIFY ASIMTUFII, like other antipsychotics, may impair judgment, thinking, or motor skills. Patients should be cautioned about performing activities that require mental alertness such as operating hazardous machinery or operating a motor vehicle, until they are reasonably certain that therapy with ABILIFY ASIMTUFII does not affect them adversely.

### 5.12 Body Temperature Regulation

Disruption of the body's ability to reduce core body temperature has been attributed to antipsychotic agents. Appropriate care is advised when prescribing ABILIFY ASIMTUFII for patients who will be experiencing conditions which may contribute to an elevation in core body temperature, (e.g., exercising strenuously, exposure to extreme heat, receiving concomitant medication with anticholinergic activity, or being subject to dehydration).

### 5.13 Dysphagia

Esophageal dysmotility and aspiration have been associated with antipsychotic drug use, including aripiprazole. ABILIFY ASIMTUFII and other antipsychotic drugs should be used cautiously in patients at risk for aspiration.

## 6 ADVERSE REACTIONS

The following adverse reactions are discussed in more detail in other sections of the labeling:

- Increased Mortality in Elderly Patients with Dementia - Related Psychosis Use [see [Boxed Warning](#) and *Warnings and Precautions (5.1)*]
- Cerebrovascular Adverse Reactions, Including Stroke in Elderly Patients with Dementia-Related Psychosis [see *Warnings and Precautions (5.2)*]
- Neuroleptic Malignant Syndrome [see *Warnings and Precautions (5.3)*]
- Tardive Dyskinesia [see *Warnings and Precautions (5.4)*]
- Metabolic Changes [see *Warnings and Precautions (5.5)*]
- Pathological Gambling and Other Compulsive Behaviors [see *Warnings and Precautions (5.6)*]
- Orthostatic Hypotension and Syncope [see *Warnings and Precautions (5.7)*]
- Falls [see *Warnings and Precautions (5.8)*]
- Leukopenia, Neutropenia, and Agranulocytosis [see *Warnings and Precautions (5.9)*]
- Seizures [see *Warnings and Precautions (5.10)*]
- Potential for Cognitive and Motor Impairment [see *Warnings and Precautions (5.11)*]
- Body Temperature Regulation [see *Warnings and Precautions (5.12)*]

- Dysphagia [see *Warnings and Precautions* (5.13)]

## 6.1 Clinical Trials Experience

Because clinical trials are conducted under widely varying conditions, adverse reaction rates observed in the clinical trials of a drug cannot be directly compared to rates in the clinical trials of another drug and may not reflect the rates observed in practice.

The safety of ABILIFY ASIMTUFII for the treatment of schizophrenia in adults and maintenance monotherapy treatment of bipolar I disorder in adults is based on adequate and well-controlled studies of Abilify Maintena. The safety data from those studies is presented below.

### Safety Database of Abilify Maintena (once monthly dosing) and Oral Aripiprazole.

Oral aripiprazole has been evaluated for safety in 16,114 adult patients who participated in multiple-dose, clinical trials in schizophrenia and other indications, and who had approximately 8,578 patient-years of exposure to oral aripiprazole. A total of 3,901 patients were treated with oral aripiprazole for at least 180 days, 2,259 patients were treated with oral aripiprazole for at least 360 days, and 933 patients continuing aripiprazole treatment for at least 720 days.

Abilify Maintena (once monthly dosing) has been evaluated for safety in 2,128 adult patients in clinical trials in schizophrenia, with approximately 2,633 patient-years of exposure to Abilify Maintena. A total of 1,229 patients were treated with Abilify Maintena for at least 180 days (at least 7 consecutive injections) and 935 patients treated with Abilify Maintena had at least 1 year of exposure (at least 13 consecutive injections).

Abilify Maintena has been evaluated for safety in 804 adult patients in clinical trials in bipolar I disorder, with approximately 530 patient-years of exposure to Abilify Maintena. A total of 419 patients were treated with Abilify Maintena for at least 180 days (at least 7 consecutive injections) and 287 patients treated with Abilify Maintena had at least 1 year of exposure (at least 13 consecutive injections).

### Safety Database of ABILIFY ASIMTUFII (once every 2 month dosing)

In a 32-week open-label study of ABILIFY ASIMTUFII in adult patients with schizophrenia or bipolar I disorder, 266 patients were randomized to receive either ABILIFY ASIMTUFII 960 mg (132 patients) or Abilify Maintena 400 mg (134 patients). A total of the 132 patients received at least one injection of ABILIFY ASIMTUFII, a total of 114 patients received at least two consecutive injections (4 months treatment) of ABILIFY ASIMTUFII, and a total of 104 patients received at least four consecutive injections (8 months treatment) of ABILIFY ASIMTUFII. Of the total 266 patients receiving ABILIFY ASIMTUFII 960 mg or Abilify Maintena 400 mg, 185 had schizophrenia and 81 had bipolar I disorder. Injection site reactions for ABILIFY ASIMTUFII (once every 2 month dosing) presented in this section is based on this open-label study (see section titled "Injection Site Reactions with Abilify ASIMTUFII").

### Adverse Reactions in Studies with Abilify Maintena (once monthly dosing)

The conditions and duration of treatment with Abilify Maintena included double-blind and open-label studies. The safety data presented below are derived from the 12-week double-blind placebo-controlled study of Abilify Maintena in adult patients with schizophrenia.

#### *Most Commonly Observed Adverse Reactions in Double-Blind, Placebo-Controlled Clinical Trials in Schizophrenia with Abilify Maintena*

Based on the placebo-controlled trial of Abilify Maintena in schizophrenia, the most commonly observed adverse reactions associated with the use of Abilify Maintena in patients (incidence of

5% or greater and aripiprazole incidence at least twice that for placebo) were increased weight (16.8% vs. 7.0%), akathisia (11.4% vs. 3.5%), injection site pain (5.4% vs. 0.6%) and sedation (5.4% vs. 1.2%).

*Commonly Reported Adverse Reactions in Double-Blind, Placebo-Controlled Clinical Trials in Schizophrenia with Abilify Maintena*

The following findings are based on the double-blind, placebo-controlled trial that compared Abilify Maintena 400 mg or 300 mg to placebo in patients with schizophrenia. Table 6 lists the adverse reactions reported in 2% or more of Abilify Maintena-treated patients and at a greater proportion than in the placebo group.

**Table 6: Adverse Reactions in ≥2% of Adult Patients with Schizophrenia Treated with Abilify Maintena in a 12-Week Double-Blind, Placebo-Controlled Study\***

Preferred Term	Abilify Maintena (n=167)	Placebo (n=172)
<b>Gastrointestinal Disorders</b>		
Constipation	10	7
Dry Mouth	4	2
Diarrhea	3	2
Vomiting	3	1
Abdominal Discomfort	2	1
<b>General Disorders and Administration Site Conditions</b>		
Injection Site Pain	5	1
<b>Infections and Infestations</b>		
Upper Respiratory Tract Infection	4	2
<b>Investigations</b>		
Increased Weight	17	7
Decreased Weight	4	2
<b>Musculoskeletal and Connective Tissue Disorders</b>		
Arthralgia	4	1
Back Pain	4	2
Myalgia	4	2
Musculoskeletal pain	3	1
<b>Nervous System Disorders</b>		
Akathisia	11	4
Sedation	5	1
Dizziness	4	2
Tremor	3	1
<b>Respiratory, Thoracic and Mediastinal</b>		
Nasal Congestion	2	1

\*This table does not include adverse reactions which had an incidence equal to or less than placebo.



### *Demographic Differences*

An examination of population subgroups was performed across demographic subgroup categories for adverse reactions experienced by at least 5% of Abilify Maintena patients at least twice the rate of placebo (i.e., increased weight, akathisia, injection site pain, and sedation) in the double-blind placebo-controlled trial. This analysis did not reveal evidence of differences in safety differential adverse reaction incidence on the basis of age, gender, or race alone; however, there were few patients  $\geq 65$  years of age.

### *Injection Site Reactions with ABILIFY ASIMTUFII*

ABILIFY ASIMTUFII was evaluated in 266 patients with schizophrenia or bipolar I disorder in an open-label, multiple-dose, randomized, parallel-arm multi-center study.

The percentage of patients in the open-label study reporting any injection site-related adverse reactions (all reported as injection site pain) was 19% for patients treated with ABILIFY ASIMTUFII 960 mg and 9% for patients treated with Abilify Maintena 400 mg. In both treatment groups, the majority of the injection site pain events coincided with the first injection of ABILIFY ASIMTUFII 960 mg (21/24 patients) or Abilify Maintena 400 mg (7/12 patients), was reported with decreasing frequency upon subsequent injections. The overall mean visual analog scale scores (0=no pain to 100=unbearably painful) for patient reported rating of pain were similar in both treatment groups at the last injection: 0.8 pre-dose and 1.4 post-dose for the ABILIFY ASIMTUFII 960 mg group compared to 1.3 post-dose for the Abilify Maintena 400 mg group.

### *Extrapyramidal Symptoms (EPS)*

In the short-term, placebo-controlled trial of Abilify Maintena in adults with schizophrenia, the incidence of reported EPS-related events, excluding events related to akathisia, for Abilify Maintena-treated patients was 9.6% vs. 5.2% for placebo. The incidence of akathisia-related events for Abilify Maintena-treated patients was 11.5% vs. 3.5% for placebo.

### *Dystonia*

Symptoms of dystonia, prolonged abnormal contractions of muscle groups, may occur in susceptible individuals during the first few days of treatment. Dystonic symptoms include: spasm of the neck muscles, sometimes progressing to tightness of the throat, swallowing difficulty, difficulty breathing, and/or protrusion of the tongue. While these symptoms can occur at low doses, they occur more frequently and with greater severity with high potency and at higher doses of first-generation antipsychotic drugs. An elevated risk of acute dystonia is observed in males and younger age groups. In the short-term, placebo-controlled trial of Abilify Maintena in adults with schizophrenia, the incidence of dystonia was 1.8% for Abilify Maintena vs. 0.6% for placebo.

### *Neutropenia*

In the short-term, placebo-controlled trial of Abilify Maintena in adults with schizophrenia, the incidence of neutropenia (absolute neutrophil count  $\leq 1.5$  thous/mcL) for Abilify Maintena-treated patients was 5.7% vs. 2.1% for placebo. An absolute neutrophil count of  $< 1$  thous/mcL (i.e., 0.95 thous/mcL) was observed in only one patient on Abilify Maintena and resolved spontaneously without any associated adverse reactions [see [Warnings and Precautions \(5.9\)](#)].

### Other Adverse Reactions During the Clinical Trial Evaluation of Abilify Maintena

The following listing does not include reactions: 1) already listed in previous tables or elsewhere in labeling, 2) for which a drug cause was remote, 3) which were so general as to be

uninformative, 4) which were not considered to have significant clinical implications, or 5) which occurred at a rate equal to or less than placebo.

- *Blood and Lymphatic System Disorders*: thrombocytopenia
- *Cardiac Disorders*: bradycardia, sinus tachycardia, tachycardia
- *Endocrine Disorders*: hypoprolactinemia
- *Eye Disorders*: vision blurred, oculogyric crisis
- *Gastrointestinal Disorders*: abdominal pain upper, dyspepsia, nausea, swollen tongue
- *General Disorders and Administration Site Conditions*: chest discomfort, fatigue, gait disturbance, injection site reaction (erythema, induration, pruritis, swelling, rash, inflammation, hemorrhage), irritability, pyrexia
- *Hepatobiliary Disorders*: drug-induced liver injury
- *Immune System Disorders*: drug hypersensitivity
- *Infections and Infestations*: nasopharyngitis
- *Investigations*: blood creatine phosphokinase increased, blood cholesterol decreased, blood pressure decreased, blood triglycerides decreased, electrocardiogram T wave abnormal, electrocardiogram QT-prolonged, hepatic enzyme increased, liver function test abnormal
- *Metabolism and Nutrition Disorders*: decreased appetite, hyperinsulinaemia, obesity
- *Musculoskeletal and Connective Tissue Disorders*: joint stiffness, muscle twitching, rhabdomyolysis, trismus
- *Nervous System Disorders*: bradykinesia, convulsion, dysgeusia, extrapyramidal disorder, hypersomnia, lethargy, memory impairment, oromandibular dystonia,
- *Psychiatric Disorders*: anxiety, insomnia, restlessness, agitation, bruxism, psychotic disorder, suicidal ideation, aggression, hypersexuality, panic attack
- *Renal and Urinary Disorders*: glycosuria, pollakiuria, urinary incontinence
- *Reproductive System and Breast Disorders*: ejaculation delayed
- *Vascular Disorders*: hypertension

#### Adverse Reactions Reported in Clinical Trials with Oral Aripiprazole

The following is a list of additional adverse reactions that have been reported in clinical trials with oral aripiprazole and not reported above for ABILIFY MAINTENA:

- *Cardiac Disorders*: angina pectoris, atrial flutter, atrioventricular block, cardiopulmonary failure, cardio-respiratory arrest, extrasystoles, myocardial infarction, myocardial ischemia, palpitations, supraventricular tachycardia, ventricular tachycardia
- *Eye Disorders*: diplopia, photophobia, eyelid edema, photopsia
- *Gastrointestinal Disorders*: gastroesophageal reflux disease, swollen tongue, esophagitis, pancreatitis, stomach discomfort, toothache
- *General Disorders and Administration Site Conditions*: asthenia, chest pain, face edema, hypothermia, peripheral edema, pain
- *Hepatobiliary Disorders*: hepatitis, jaundice
- *Immune System Disorders*: hypersensitivity
- *Injury, Poisoning, and Procedural Complications*: heat stroke

- *Investigations:* blood bilirubin increased, blood creatinine increased, blood glucose increased, blood lactate dehydrogenase increased, blood prolactin increased, blood urea increased, glycosylated hemoglobin increased
- *Metabolism and Nutrition Disorders:* anorexia, diabetic ketoacidosis, hyponatremia, hypoglycemia, polydipsia
- *Musculoskeletal and Connective Tissue Disorders:* mobility decreased, muscle rigidity, muscle tightness, muscular weakness, musculoskeletal stiffness, pain in extremity, muscle spasms
- *Nervous System Disorders:* akinesia, choreoathetosis, coordination abnormal, hypokinesia, hypotonia, myoclonus, speech disorder
- *Psychiatric Disorders:* anger, anorgasmia, catatonia, completed suicide, delirium, loss of libido, homicidal ideation, intentional self-injury, hostility, libido increased, sleep walking, suicide attempt, tic
- *Renal and Urinary Disorders:* nocturia, polyuria, urinary retention
- *Reproductive System and Breast Disorders:* amenorrhea, breast pain, erectile dysfunction, gynecomastia, menstruation irregular, priapism
- *Respiratory, Thoracic, and Mediastinal Disorders:* dyspnea, nasal congestion, pharyngolaryngeal pain, cough
- *Skin and Subcutaneous Tissue Disorders:* alopecia, hyperhidrosis, photosensitivity reaction, pruritus, rash (including erythematous, exfoliative, generalized, macular, maculopapular, papular rash; acneiform, allergic, contact, exfoliative, seborrheic dermatitis, neurodermatitis, and drug eruption), urticaria

## 6.2 Postmarketing Experience

The following adverse reactions have been identified during post-approval use of aripiprazole. Because these reactions are reported voluntarily from a population of uncertain size, it is not always possible to reliably estimate their frequency or establish a causal relationship to drug exposure: occurrences of allergic reaction (anaphylactic reaction, angioedema, laryngospasm, pruritus/urticaria, or oropharyngeal spasm), blood glucose fluctuation, drug reaction with eosinophilia and systemic symptoms (DRESS), hiccups, pathological gambling.

## 7 DRUG INTERACTIONS

### 7.1 Drugs Having Clinically Important Interactions with ABILIFY ASIMTUFII

Table 7 presents clinically significant drug interactions with ABILIFY ASIMTUFII.

**Table 7: Clinically Important Drug Interactions with ABILIFY ASIMTUFII**

<b>Strong CYP3A4 Inhibitors AND/OR strong CYP2D6 inhibitors</b>	
Clinical Rationale	Concomitant use of oral aripiprazole with strong CYP3A4 AND/OR CYP2D6 inhibitors increased the exposure of aripiprazole [see <i>Clinical Pharmacology</i> ( <a href="#">12.3</a> )].
Clinical Recommendation	<u>Concomitant use of a strong CYP3A4 inhibitor OR a strong CYP2D6 inhibitor</u> Reduce the dosage of ABILIFY ASIMTUFII when administered concomitantly with a strong CYP3A4 inhibitor

---

**OR** a strong CYP2D6 inhibitor for more than 14 days [see *Dosage and Administration* (2.4)].

Concomitant Use of a strong CYP3A4 inhibitor **AND** a strong CYP2D6 inhibitor

Avoid use of ABILIFY ASIMTUFII when administered concomitantly with a strong CYP3A4 inhibitor **AND** a strong CYP2D6 inhibitor for more than 14 days [see *Dosage and Administration* (2.4)].

---

**Strong CYP3A4 Inducers**

---

Clinical Rationale Concomitant use of oral aripiprazole and carbamazepine decreased the exposure of aripiprazole [see *Clinical Pharmacology* (12.3)].

---

Clinical Recommendation Avoid use of ABILIFY ASIMTUFII in combination with a strong CYP3A4 inducer (e.g., carbamazepine) for greater than 14 days [see *Dosage and Administration* (2.4)].

---

**Antihypertensive Drugs**

---

Clinical Rationale Due to its alpha-adrenergic antagonism, aripiprazole has the potential to enhance the effect of certain antihypertensive agents.

---

Clinical Recommendation Monitor blood pressure and adjust dose accordingly [see *Warnings and Precautions* (5.7)].

---

**Benzodiazepines**

---

Clinical Rationale The intensity of sedation was greater with the combination of oral aripiprazole and lorazepam as compared to that observed with aripiprazole alone. The orthostatic hypotension observed was greater with the combination as compared to that observed with lorazepam alone [see *Warnings and Precautions* (5.7)].

---

Clinical Recommendation Monitor sedation and blood pressure. Adjust dose accordingly.

---

**7.2 Drugs Having No Clinically Important Interactions with ABILIFY ASIMTUFII**

Based on pharmacokinetic studies with oral aripiprazole, no dosage adjustment of ABILIFY ASIMTUFII is required when administered concomitantly with famotidine, valproate, lithium, lorazepam [see *Clinical Pharmacology* (12.3)].

In addition, no dosage adjustment is necessary for substrates of CYP2D6, CYP2C9, CYP2C19, or CYP3A4 when coadministered with ABILIFY ASIMTUFII. Additionally, no dosage adjustment is necessary for valproate, lithium, lamotrigine, lorazepam, or sertraline when coadministered with ABILIFY ASIMTUFII [see *Clinical Pharmacology* (12.3)].

## 8 USE IN SPECIFIC POPULATIONS

### 8.1 Pregnancy

#### Pregnancy Exposure Registry

There is a pregnancy exposure registry that monitors pregnancy outcomes in women exposed to atypical antipsychotics, including aripiprazole, during pregnancy. Healthcare providers are encouraged to register patients by contacting the National Pregnancy Registry for Atypical Antipsychotics at 1-866-961-2388 or visit <http://womensmentalhealth.org/clinical-and-research-programs/pregnancyregistry/>.

#### Risk Summary

Neonates exposed to antipsychotic drugs, including ABILIFY ASIMTUFII, during the third trimester of pregnancy are at risk for extrapyramidal and/or withdrawal symptoms (*see Clinical Considerations*). There are insufficient data with ABILIFY ASIMTUFII use in pregnant women to inform a drug-associated risk. In animal reproduction studies, oral and intravenous aripiprazole administration during organogenesis in rats and/or rabbits at doses 10 and 11 times, respectively, the maximum recommended human oral dose (MRHD) produced fetal death, decreased fetal weight, undescended testicles, delayed skeletal ossification, skeletal abnormalities, and diaphragmatic hernia. Oral and intravenous aripiprazole administration during the pre- and post-natal period in rats at doses 10 times the oral MRHD produced prolonged gestation, stillbirths, decreased pup weight, and decreased pup survival (*see Data*). Consider the benefits and risks of ABILIFY ASIMTUFII and possible risks to the fetus when prescribing ABILIFY ASIMTUFII to a pregnant woman. Advise pregnant women of potential fetal risk.

The background risk of major birth defects and miscarriage for the indicated population are unknown. In the U.S. general population, the estimated background risk of major birth defects and miscarriage in clinically recognized pregnancies is 2-4% and 15-20%, respectively.

#### Clinical Considerations

##### *Fetal/Neonatal Adverse Reactions*

Extrapyramidal and/or withdrawal symptoms, including agitation, hypertonia, hypotonia, tremor, somnolence, respiratory distress and feeding disorder have been reported in neonates who were exposed to antipsychotic drugs, including oral aripiprazole, during the third trimester of pregnancy. These symptoms have varied in severity. Some neonates recovered within hours or days without specific treatment; others required prolonged hospitalization. Monitor neonates exhibiting extrapyramidal and/or withdrawal symptoms and manage symptoms appropriately.

#### Data

##### *Animal Data*

No developmental toxicity studies were conducted with intramuscular aripiprazole suspension.

In animal oral or intravenous studies, aripiprazole demonstrated developmental toxicity, including possible teratogenic effects in rats and rabbits.

Pregnant rats were treated with oral doses of 3, 10, and 30 mg/kg/day which are approximately 1 to 10 times the oral MRHD of 30 mg/day on mg/m<sup>2</sup> basis of aripiprazole during the period of organogenesis. Treatment at the highest dose caused a slight prolongation of gestation and delay in fetal development, as evidenced by decreased fetal weight and undescended testes. Delayed skeletal ossification was observed at 3 and 10 times the oral MRHD on mg/m<sup>2</sup> basis.

At 3 and 10 times the oral MRHD on mg/m<sup>2</sup> basis, delivered offspring had decreased body weights. Increased incidences of hepatodiaphragmatic nodules and diaphragmatic hernia were observed in offspring from the highest dose group (the other dose groups were not examined for these findings). Postnatally, delayed vaginal opening was seen at 3 and 10 times the oral MRHD on mg/m<sup>2</sup> basis and impaired reproductive performance (decreased fertility rate, corpora lutea, implants, live fetuses, and increased post-implantation loss, likely mediated through effects on female offspring) along with some maternal toxicity were seen at the highest dose; however, there was no evidence to suggest that these developmental effects were secondary to maternal toxicity.

In pregnant rats treated with aripiprazole intravenously at doses of 3, 9, and 27 mg/kg/day, which are 1 to 9 times the oral MRHD on mg/m<sup>2</sup> basis, during the period of organogenesis, decreased fetal weight and delayed skeletal ossification were seen at the highest dose which also caused maternal toxicity.

In pregnant rabbits treated with oral doses of 10, 30, and 100 mg/kg/day which are 2 to 11 times human exposure at the oral MRHD based on AUC and 6 to 65 times the oral MRHD of aripiprazole on mg/m<sup>2</sup> basis during the period of organogenesis, decreased maternal food consumption and increased abortions were seen at the highest dose as well as increased fetal mortality. Decreased fetal weight and increased incidence of fused sternebrae were observed at 3 and 11 times the oral MRHD based on AUC.

In pregnant rabbits receiving aripiprazole injection intravenously at doses of 3, 10, and 30 mg/kg/day, which are 2 to 19 times the oral MRHD on mg/m<sup>2</sup> basis during the period of organogenesis, the highest dose caused pronounced maternal toxicity that resulted in decreased fetal weight, increased fetal abnormalities (primarily skeletal), and decreased fetal skeletal ossification. The fetal no-effect dose was 5 times the human exposure at the oral MRHD based on AUC and is 6 times the oral MRHD on mg/m<sup>2</sup> basis.

In rats treated with oral doses of 3, 10, and 30 mg/kg/day, which are 1 to 10 times the oral MRHD of aripiprazole on a mg/m<sup>2</sup> basis, peri- and post-natally (from Day 17 of gestation through Day 21 postpartum), slight maternal toxicity and slightly prolonged gestation were seen at the highest dose. An increase in stillbirths and decreases in pup weight (persisting into adulthood) and survival were also seen at this dose.

In rats treated with aripiprazole intravenously at doses of 3, 8, and 20 mg/kg/day which are 1 to 6 times the oral MRHD on mg/m<sup>2</sup> basis from Day 6 of gestation through Day 20 postpartum, increased stillbirths were seen at 3 and 6 times the oral MRHD on mg/m<sup>2</sup> basis, and decreases in early postnatal pup weight and survival were seen at the highest dose; these doses produced some maternal toxicity. There were no effects on postnatal behavioral and reproductive development.

## **8.2 Lactation**

### Risk Summary

Aripiprazole is present in human breast milk; however, there are insufficient data to assess the amount in human milk, the effects on the breastfed infant, or the effects on milk production. The development and health benefits of breastfeeding should be considered along with the mother's clinical need for ABILIFY ASIMTUFII and any potential adverse effects on the breastfed infant from ABILIFY ASIMTUFII or from the underlying maternal condition.

## 8.4 Pediatric Use

Safety and effectiveness of ABILIFY ASIMTUFII in pediatric patients have not been established.

### Juvenile Animal Studies

No juvenile animal studies were conducted with intramuscular aripiprazole suspension. A study with oral aripiprazole in juvenile rats caused mortality, CNS clinical signs, impaired memory and learning, and delayed sexual maturation when administered at doses of 10, 20, 40 mg/kg/day from weaning (21 days old) through maturity (80 days old). At 40 mg/kg/day, mortality, decreased activity, splayed hind limbs, hunched posture, ataxia, tremors and other CNS signs were observed in both genders. In addition, delayed sexual maturation was observed in males. At all doses and in a dose-dependent manner, impaired memory and learning, increased motor activity, and histopathology changes in the pituitary (atrophy), adrenals (adrenocortical hypertrophy), mammary glands (hyperplasia and increased secretion), and female reproductive organs (vaginal mucification, endometrial atrophy, decrease in ovarian corpora lutea) were observed. The changes in female reproductive organs were considered secondary to the increase in prolactin serum levels. A No Observed Adverse Effect Level (NOAEL) could not be determined and, at the lowest tested dose of 10 mg/kg/day, there is no safety margin relative to the systemic exposures ( $AUC_{0-24}$ ) for aripiprazole or its major active metabolite in adolescents at the maximum recommended oral pediatric dose of 15 mg/day. All drug-related effects were reversible after a 2-month recovery period, and most of the drug effects in juvenile rats were also observed in adult rats from previously conducted studies.

Aripiprazole in juvenile dogs (2 months old) caused CNS clinical signs of tremors, hypoactivity, ataxia, recumbency and limited use of hind limbs when administered orally for 6 months at 3, 10, 30 mg/kg/day. Mean body weight and weight gain were decreased up to 18% in females in all drug groups relative to control values. A NOAEL could not be determined and, at the lowest tested dose of 3 mg/kg/day, there is no safety margin relative to the systemic exposures ( $AUC_{0-24}$ ) for aripiprazole or its major active metabolite in adolescents at the maximum recommended oral pediatric dose of 15 mg/day. All drug-related effects were reversible after a 2-month recovery period.

## 8.5 Geriatric Use

Clinical studies of ABILIFY ASIMTUFII did not include sufficient numbers of subjects aged 65 years and over to determine whether they respond differently from younger subjects. Other reported clinical experience and pharmacokinetic data have not identified differences in responses between the elderly and younger patients. In general, dose selection for an elderly patient should be cautious, usually starting at the low end of the dosing range, reflecting the greater frequency of decreased hepatic, renal, or cardiac function, and of concomitant disease or other drug therapy.

In single-dose and multiple-dose pharmacokinetic studies with oral aripiprazole, there was no detectable age effect in the population pharmacokinetic analysis in schizophrenia patients. No dosage adjustments are recommended based on age alone. ABILIFY ASIMTUFII is not approved for the treatment of patients with dementia-related psychosis [see also [Boxed Warning and Warnings and Precautions \(5.1\)](#)].

## 8.6 CYP2D6 Poor Metabolizers

Dosage adjustment is recommended in known CYP2D6 poor metabolizers due to high aripiprazole concentrations. Approximately 8% of Caucasians and 3% to 8% of Black/African

Americans cannot metabolize CYP2D6 substrates and are classified as poor metabolizers (PM) [see *Dosage and Administration* (2.4)].

### 8.7 Renal Impairment

No dosage adjustment for ABILIFY ASIMTUFII is required on the basis of a patient's renal function (mild to severe renal impairment, glomerular filtration rate between 15 and 90 mL/minute) [see *Dosage and Administration* (2.4)].

### 8.8 Hepatic Impairment

No dosage adjustment for ABILIFY ASIMTUFII is required on the basis of a patient's hepatic function (mild to severe hepatic impairment, Child-Pugh score between 5 and 15).

## 10 OVERDOSAGE

### Human Experience

Common adverse reactions (reported in at least 5% of all overdose cases) reported with oral aripiprazole overdose (alone or in combination with other substances) include vomiting, somnolence, and tremor. Other clinically important signs and symptoms observed in one or more patients with aripiprazole overdoses (alone or with other substances) include acidosis, aggression, aspartate aminotransferase increased, atrial fibrillation, bradycardia, coma, confusional state, convulsion, blood creatine phosphokinase increased, depressed level of consciousness, hypertension, hypokalemia, hypotension, lethargy, loss of consciousness, QRS complex prolonged, QT prolonged, pneumonia aspiration, respiratory arrest, status epilepticus, and tachycardia.

### Management of Overdosage

Consider contacting the Poison Help line (1-800-222-1222) or medical toxicologist for additional overdose management recommendations.

## 11 DESCRIPTION

Aripiprazole is an atypical antipsychotic which is present in ABILIFY ASIMTUFII as its monohydrate polymorphic form. Aripiprazole monohydrate is 7-[4-[4-(2,3-dichlorophenyl)-1-piperazinyl] butoxy]-3,4 dihydrocarbostyryl monohydrate. The empirical formula is  $C_{23}H_{27}Cl_2N_3O_2 \cdot H_2O$  and its molecular weight is 466.40. The chemical structure is:

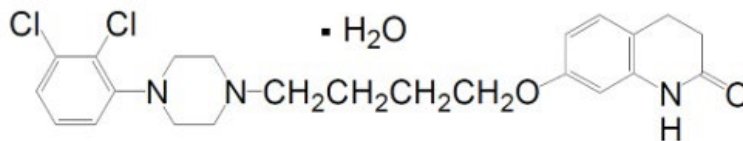

ABILIFY ASIMTUFII (aripiprazole) is available as a white to off-white, sterile, aqueous extended-release suspension for intramuscular injection in 720 mg or 960 mg dose strength, pre-filled syringes. The labeled strengths are calculated based on the anhydrous form (aripiprazole). Inactive ingredients are carboxymethylcellulose sodium (5 mg/mL), polyethylene glycol 400 (1 mg/mL), povidone (4 mg/mL), sodium chloride (6.1 mg/mL), sodium phosphate monobasic monohydrate (0.74 mg/mL), sodium hydroxide (to adjust pH) and water for injection (q.s.).



## 12 CLINICAL PHARMACOLOGY

### 12.1 Mechanism of Action

The mechanism of action of aripiprazole in the treatment of schizophrenia and bipolar I disorder is unknown.

The efficacy of aripiprazole could be mediated through a combination of partial agonist activity at dopamine D<sub>2</sub> and serotonin 5-HT<sub>1A</sub> receptors and antagonist activity at 5-HT<sub>2A</sub> receptors.

### 12.2 Pharmacodynamics

Aripiprazole exhibits high affinity for dopamine D<sub>2</sub> and D<sub>3</sub> (K<sub>i</sub>s 0.34 and 0.8 nM, respectively), serotonin 5-HT<sub>1A</sub> and 5-HT<sub>2A</sub> receptors (K<sub>i</sub>s 1.7 and 3.4 nM, respectively), moderate affinity for dopamine D<sub>4</sub>, serotonin 5-HT<sub>2C</sub> and 5-HT<sub>7</sub>, alpha<sub>1</sub>-adrenergic and histamine H<sub>1</sub> receptors (K<sub>i</sub>s of 44 nM, 15 nM, 39 nM, 57 nM, and 61 nM, respectively), and moderate affinity for the serotonin reuptake site (K<sub>i</sub>=98 nM). Aripiprazole has no appreciable affinity for cholinergic muscarinic receptors (IC<sub>50</sub>>1000 nM). Actions at receptors other than D<sub>2</sub>, 5-HT<sub>1A</sub>, and 5-HT<sub>2A</sub> could explain some of the other adverse reactions of aripiprazole (e.g., the orthostatic hypotension observed with aripiprazole may be explained by its antagonist activity at adrenergic alpha<sub>1</sub> receptors).

### 12.3 Pharmacokinetics

ABILIFY ASIMTUFII activity is presumably primarily due to the parent drug, aripiprazole, and to a lesser extent, to its major metabolite, dehydro-aripiprazole, which has been shown to have affinities for D<sub>2</sub> receptors similar to the parent drug and represents about 29% of the parent drug exposure in plasma.

ABILIFY ASIMTUFII delivers aripiprazole over a 2-month period. ABILIFY ASIMTUFII has linear PK in the approved dose range. Steady-state aripiprazole exposures were reached by the fourth dose. Plasma exposures at steady state were compared between ABILIFY ASIMTUFII (960 mg, once every 2 months) and Abilify Maintena (400 mg, once every month). The average plasma concentrations (C<sub>avg</sub>) of aripiprazole were 263 ng/mL and 280 ng/mL for ABILIFY ASIMTUFII and Abilify Maintena, respectively. The C<sub>max</sub> of aripiprazole were 342 ng/mL and 344 ng/mL for ABILIFY ASIMTUFII and Abilify Maintena, respectively.

**Figure 9: Mean Plasma Concentration of Aripiprazole Following the Fourth Administration of ABILIFY ASIMTUFII 960 mg versus the Eighth Administration of Abilify Maintena 400 mg**

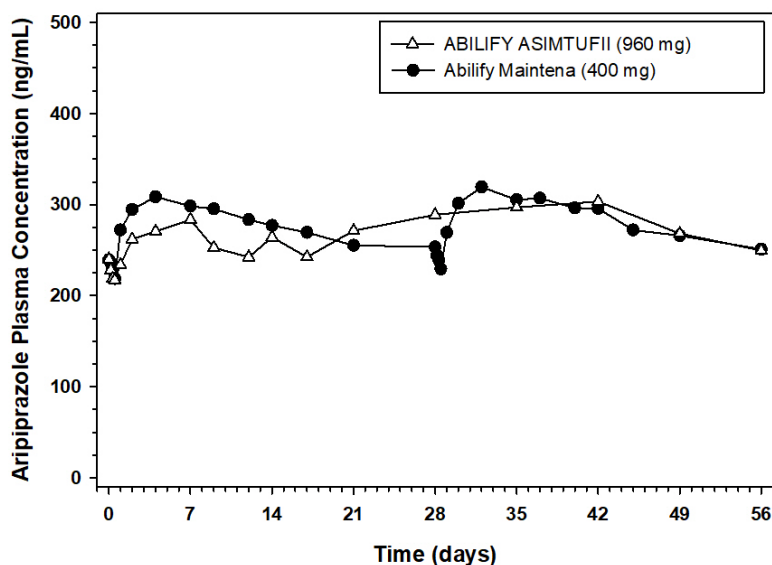

### Absorption

Aripiprazole absorption into the systemic circulation is prolonged following gluteal intramuscular injection due to low solubility of aripiprazole particles. The release profile of aripiprazole from ABILIFY ASIMTUFII results in sustained plasma concentrations over 2 months following gluteal injection(s). Following multiple doses, the median peak:trough ratio for aripiprazole following an ABILIFY ASIMTUFII dose is 1.3, resulting in a flat plasma concentration profile with  $T_{max}$  ranging between 1 to 49 days following multiple gluteal administrations of 960 mg.

### Distribution

Based on results from trials with oral administration of aripiprazole, aripiprazole is widely distributed throughout the body with an apparent volume of distribution of 4.9 L/kg, indicating extensive extravascular distribution. At therapeutic concentrations, aripiprazole and dehydro-aripiprazole are greater than 99% bound to serum proteins, binding primarily to albumin.

### Elimination

#### *Metabolism*

Aripiprazole is metabolized primarily by three biotransformation pathways: dehydrogenation, hydroxylation, and N-dealkylation. Based on *in vitro* studies, CYP3A4 and CYP2D6 enzymes are responsible for dehydrogenation and hydroxylation of aripiprazole, and N-dealkylation is catalyzed by CYP3A4. Aripiprazole is the predominant drug moiety in the systemic circulation. Following administration of multiple doses of ABILIFY ASIMTUFII, dehydro-aripiprazole, the active metabolite, represents approximately 30% of aripiprazole AUC in plasma.

#### *Excretion*

Following a single oral dose of [14C]-labeled aripiprazole, approximately 25% and 55% of the administered radioactivity was recovered in the urine and feces, respectively. Less than 1% of unchanged aripiprazole was excreted in the urine and approximately 18% of the oral dose was recovered unchanged in the feces.

## Drug Interaction Studies

No specific drug interaction studies have been performed with ABILIFY ASIMTUFII. The information below is obtained from studies with oral aripiprazole.

The effect of other drugs on the exposures of aripiprazole and dehydro-aripiprazole are summarized in Figure 10 and Figure 11, respectively. Based on simulations, a 4.5-fold increase in mean  $C_{max}$  and AUC values at steady-state is expected when extensive metabolizers of CYP2D6 are administered with both strong CYP2D6 and CYP3A4 inhibitors. After oral administration, a 3-fold increase in mean  $C_{max}$  and AUC values at steady-state is expected in poor metabolizers of CYP2D6 administered with strong CYP3A4 inhibitors.

**Figure 10: The Effect of Other Drugs on Aripiprazole Pharmacokinetics**

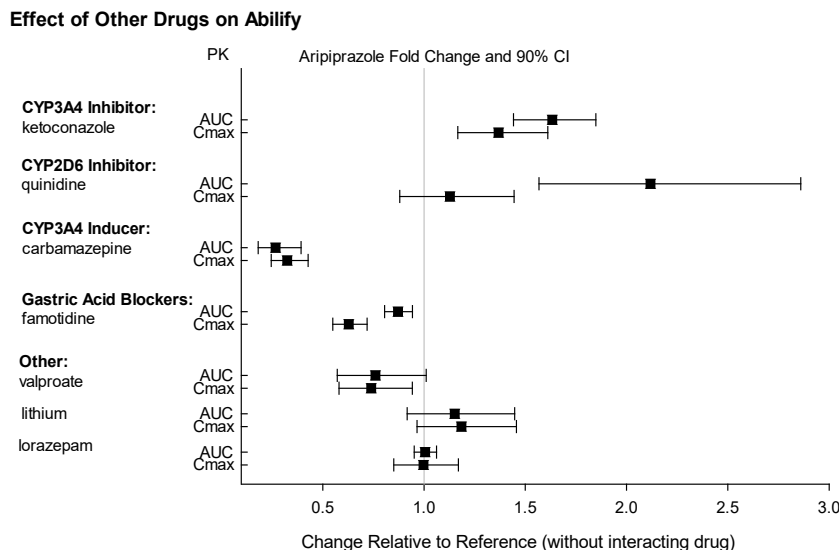

**Figure 11: The Effect of Other Drugs on Dehydro-aripiprazole Pharmacokinetics**

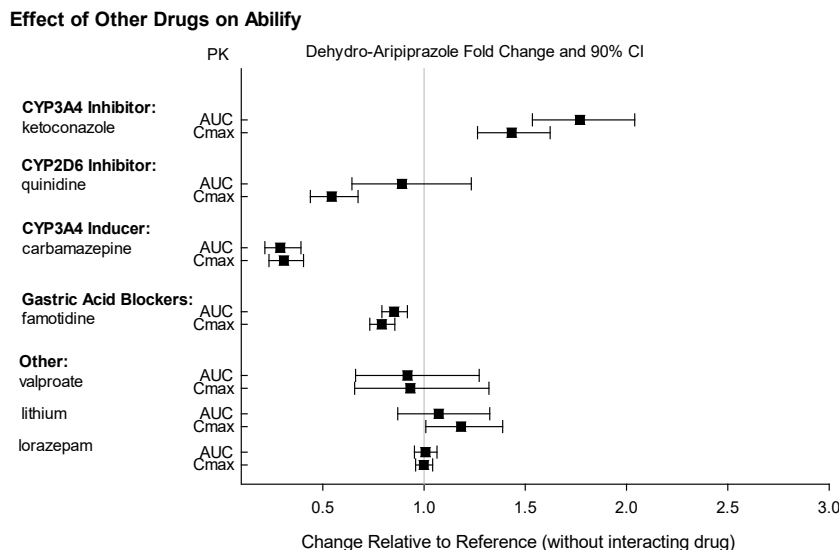

The effect of oral aripiprazole on the exposures of other drugs are summarized in Figure 13. A population PK analysis in patients with major depressive disorder showed no substantial change in plasma concentrations of fluoxetine (20 mg/day or 40 mg/day), paroxetine CR (37.5 mg/day or 50 mg/day), or sertraline (100 mg/day or 150 mg/day) dosed to steady-state. The steady-state plasma concentrations of fluoxetine and norfluoxetine increased by about 18% and 36%, respectively, and concentrations of paroxetine decreased by about 27%. The steady-state

plasma concentrations of sertraline and desmethylsertraline were not substantially changed when these antidepressant therapies were coadministered with aripiprazole.

**Figure 13: The Effect of Oral Aripiprazole on Pharmacokinetics of Other Drugs**

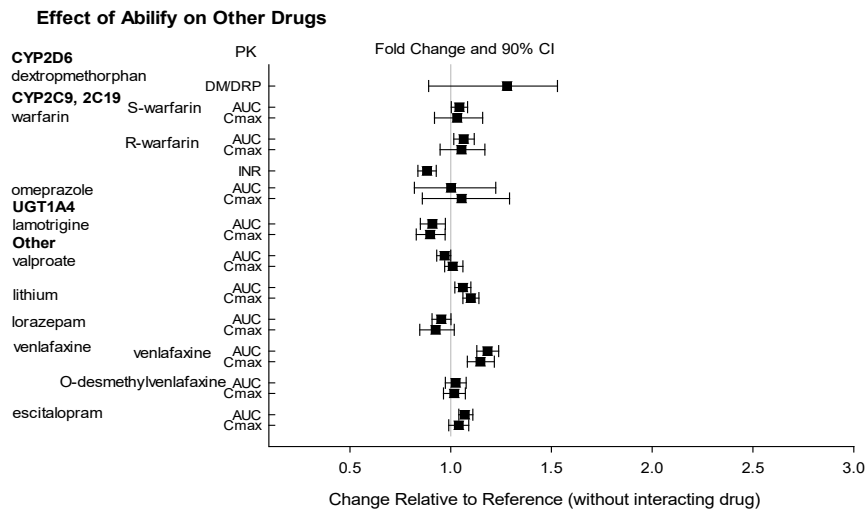

Studies in Specific Populations

No specific pharmacokinetic studies have been performed with ABILIFY ASIMTUFII in specific populations. All the information is obtained from studies with oral aripiprazole or is based on the pharmacokinetic modeling of oral aripiprazole and/or ABILIFY ASIMTUFII.

Exposures of aripiprazole and dehydro-aripiprazole in specific populations are summarized in Figure 14 and Figure 15, respectively. In addition, in pediatric patients (10 to 17 years of age) administered with oral aripiprazole (20 mg to 30 mg), the body weight corrected aripiprazole clearance was similar to the adults.

**Figure 14: Effect of Intrinsic Factors on Aripiprazole Pharmacokinetics**

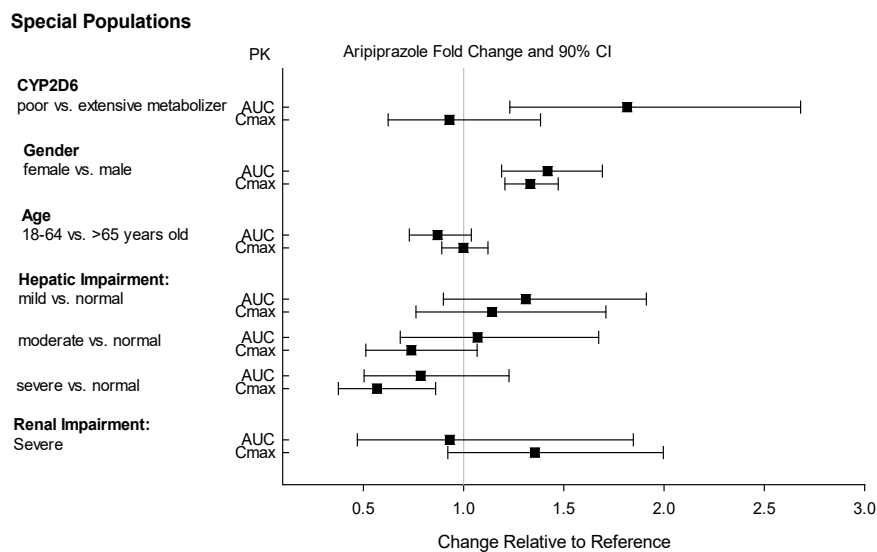

**Figure 15: Effects of Intrinsic Factors on Dehydro-aripiprazole Pharmacokinetics**

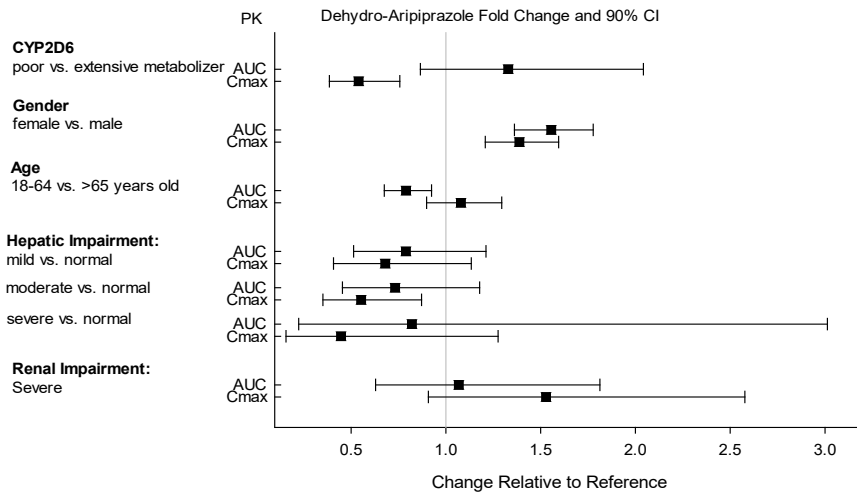

## 13 NONCLINICAL TOXICOLOGY

### 13.1 Carcinogenesis, Mutagenesis, Impairment of Fertility

#### Carcinogenesis

No carcinogenicity studies were conducted with intramuscular aripiprazole suspension.

Lifetime carcinogenicity studies were conducted with oral aripiprazole in Swiss albino mice, Sprague-Dawley (SD) rats, and F344 rats. Oral aripiprazole was administered for 2 years in the diet at doses of 1, 3, 10, and 30 mg/kg/day to ICR mice and 1, 3, and 10 mg/kg/day to F344 rats (0.2 to 5 times and 0.3 to 3 times oral MRHD based on mg/m<sup>2</sup>, respectively). In addition, SD rats were dosed orally for 2 years at 10, 20, 40, and 60 mg/kg/day (3 to 19 times the oral MRHD based on mg/m<sup>2</sup>). Aripiprazole did not induce tumors in male mice or male rats. In female mice, the incidence of pituitary gland adenomas, mammary gland adenocarcinomas and adenoacanthomas were increased at dietary doses of 3 to 30 mg/kg/day (0.5 to 5 times the oral MRHD based on mg/m<sup>2</sup>). In female rats, the incidence of mammary gland fibroadenomas was increased at a dietary dose of 10 mg/kg/day (3 times the oral MRHD based on mg/m<sup>2</sup>); and the incidences of adrenocortical carcinomas and combined adrenocortical adenomas/carcinomas were increased at an oral dose of 60 mg/kg/day (19 times the oral MRHD based on mg/m<sup>2</sup>).

Proliferative changes in the pituitary and mammary gland of rodents have been observed following chronic administration of other antipsychotic agents and are considered prolactin-mediated. Serum prolactin was not measured in the aripiprazole carcinogenicity studies. However, increases in serum prolactin levels were observed in female mice in a 13-week dietary study at the doses associated with mammary gland and pituitary tumors. Serum prolactin was not increased in female rats in 4-week and 13-week dietary studies at the dose associated with mammary gland tumors. The relevance for human risk of the findings of prolactin-mediated endocrine tumors in rodents is unknown.

#### Mutagenesis

The mutagenic potential of aripiprazole was tested in the *in vitro* bacterial reverse-mutation assay, the *in vitro* bacterial DNA repair assay, the *in vitro* forward gene mutation assay in mouse lymphoma cells, the *in vitro* chromosomal aberration assay in Chinese hamster lung (CHL) cells, the *in vivo* micronucleus assay in mice, and the unscheduled DNA synthesis assay in rats. Aripiprazole and a metabolite (2,3-DCPP) were clastogenic in the *in vitro* chromosomal aberration assay in CHL cells with and without metabolic activation. The metabolite, 2,3-DCPP,

produced increases in numerical aberrations in the *in vitro* assay in CHL cells in the absence of metabolic activation. A positive response was obtained in the *in vivo* micronucleus assay in mice; however, the response was due to a mechanism not considered relevant to humans.

### Impairment of Fertility

No mating and fertility studies were conducted with intramuscular aripiprazole suspension.

Female rats were treated with aripiprazole oral doses of 2, 6, and 20 mg/kg/day (0.6, 2, and 6 times the oral MRHD on a mg/m<sup>2</sup> basis) of aripiprazole from 2 weeks prior to mating through Day 7 of gestation. Estrus cycle irregularities and increased corpora lutea were seen at all doses, but no impairment of fertility was seen. Increased pre-implantation loss was seen at 6 and 20 mg/kg/day and decreased fetal weight was seen at 20 mg/kg/day.

Male rats were treated with oral doses of 20, 40, and 60 mg/kg/day (6, 13, and 19 times the oral MRHD on mg/m<sup>2</sup> basis) of aripiprazole from 9 weeks prior to mating through mating. Disturbances in spermatogenesis were seen at 60 mg/kg and prostate atrophy was seen at 40 and 60 mg/kg, but no impairment of fertility was seen.

## **13.2 Animal Toxicology and/or Pharmacology**

The toxicological profile for aripiprazole administered to experimental animals by intramuscular injection is generally similar to that seen following oral administration at comparable plasma levels of the drug. In dogs, repeated intramuscular dosing of the 2-month aripiprazole extended release injectable suspension over a period of 52 weeks produced no clinical evidence of significant local irritation, and resulted in slight foreign-body type of localized granulomatous inflammatory reaction to deposited drug at the injection site. These effects gradually resolved with discontinuation of dosing.

Oral aripiprazole produced retinal degeneration in albino rats in a 26-week chronic toxicity study at a dose of 60 mg/kg and in a 2-year carcinogenicity study at doses of 40 and 60 mg/kg. The 40 and 60 mg/kg/day doses are 13 and 19 times the maximum recommended human oral dose (MRHD) based on mg/m<sup>2</sup> body surface and 7 to 14 times human exposure at the oral MRHD based on AUC. Evaluation of the retinas of albino mice and of monkeys did not reveal evidence of retinal degeneration. Additional studies to further evaluate the mechanism have not been performed. The relevance of this finding to human risk is unknown.

## **14 CLINICAL STUDIES**

### **14.1 Schizophrenia**

The efficacy of ABILIFY ASIMTUFII (once every 2 month dosing) for the treatment of schizophrenia in adults is based on adequate and well-controlled studies of Abilify Maintena (once monthly dosing). The results of these adequate and well-controlled studies are presented below.

The efficacy of Abilify Maintena (once monthly dosing) for treatment of schizophrenia was established in:

- One short-term (12-week), randomized, double-blind, placebo-controlled trial in acutely relapsed adults (Study 1)
- One longer-term, double-blind, placebo-controlled, randomized-withdrawal (maintenance) trial in adults (Study 2).

## Short-Term Efficacy

In the short-term (12-week), randomized, double-blind, placebo-controlled trial in acutely relapsed adults (Study 1), the primary measure used for assessing psychiatric signs and symptoms was the Positive and Negative Syndrome Scale (PANSS). The PANSS is a 30-item scale that measures positive symptoms of schizophrenia (7 items), negative symptoms of schizophrenia (7 items), and general psychopathology (16 items), each rated on a scale of 1 (absent) to 7 (extreme); total PANSS scores range from 30 to 210. The primary endpoint was the change from baseline in PANSS total score to week 10.

The inclusion criteria for this short-term trial included adult inpatients who met DSM-IV-TR criteria for schizophrenia. In addition, all patients entering the trial must have experienced an acute psychotic episode as defined by both PANSS Total Score  $\geq 80$  and a PANSS score of  $>4$  on each of four specific psychotic symptoms (conceptual disorganization, hallucinatory behavior, suspiciousness/persecution, unusual thought content) at screening and baseline. The key secondary endpoint was the change from baseline in Clinical Global Impression-Severity (CGI-S) assessment scale to week 10. The CGI-S rates the severity of mental illness on a scale of 1 (normal) to 7 (among the most extremely ill) based on the total clinical experience of the rater in treating patients with schizophrenia. Patients had a mean PANSS total score of 103 (range 82 to 144) and a CGI-S score of 5.2 (markedly ill) at entry.

In this 12-week study (n=339) comparing Abilify Maintena (n=167) to placebo (n=172), patients were administered 400 mg Abilify Maintena or placebo on days 0, 28, and 56. The dose could be adjusted down and up within the range of 400 to 300 mg on a one-time basis. Abilify Maintena was superior to placebo in improving the PANSS total score at the end of week 10 (see Table 8).

**Table 8: Efficacy Results of Abilify Maintena in Short-term Schizophrenia Study 1 (Adults)**

Study Number	Treatment Group	Primary Efficacy Measure: PANSS Total Score		
		Mean Baseline Score (SD)	LS Mean Change from Baseline (SE)	Placebo-subtracted Difference* (95% CI)
Study 1	Abilify Maintena (400 to 300 mg)	102.4 (11.4)	-26.8 (1.6)	-15.1 (-19.4, -10.8)
	Placebo	103.4 (11.1)	-11.7 (1.6)	--

SD: standard deviation; SE: standard error; LS Mean: least-squares mean; CI: unadjusted confidence interval.

\*Difference (drug minus placebo) in least-squares mean change from baseline.

The change in PANSS total score by week is shown in Figure 16. Abilify Maintena also showed improvement in symptoms represented by CGI-S score mean change from baseline to week 10. The results of exploratory subgroup analyses by gender, race, age, ethnicity, and BMI were similar to the results of the overall population.

**Figure 16: Weekly PANSS Total Score-Change in the 12-Week, Placebo-Controlled Study with Abilify Maintena in Schizophrenia - Study 1 (Adults)**

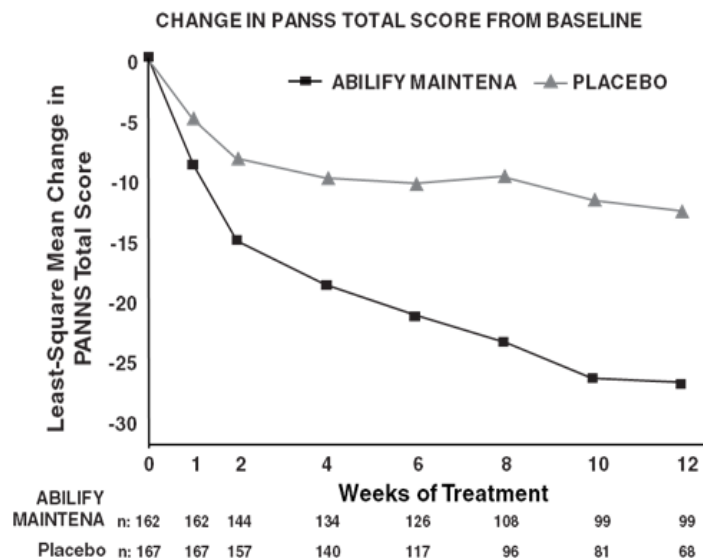

n = the number of patients remaining in the respective study arm at each time point

### Long-Term Efficacy

The efficacy of Abilify Maintena in maintaining symptomatic control in schizophrenia was established in a double-blind, placebo-controlled, randomized-withdrawal trial in adult patients (Study 2) who met DSM-IV-TR criteria for schizophrenia and who were being treated with at least one antipsychotic medication. Patients had at least a 3-year history of illness and a history of relapse or symptom exacerbation when not receiving antipsychotic treatment.

In addition to the PANSS and CGI-S, clinical ratings during this trial included the:

- Clinical Global Impression-Improvement (CGI-I) scale, a scale of 1 (very much improved) to 7 (very much worse) based on the change from baseline in clinical condition and
- Clinical Global Impression-Severity of Suicide (CGI-SS) scale, which is comprised of 2 parts: Part 1 rates the severity of suicidal thoughts and behavior on a scale of 1 (not at all suicidal) to 5 (attempted suicide) based on the most severe level in the last 7 days from all information available to the rater and Part 2 rates the change from baseline in suicidal thoughts and behavior on a scale of 1 (very much improved) to 7 (very much worse).

This trial included:

- A 4 to 6 week open-label, oral conversion phase for patients on antipsychotic medications other than aripiprazole. A total of 633 patients entered this phase.
- An open-label, oral aripiprazole stabilization phase (target dose of 10 mg to 30 mg once daily). A total of 710 patients entered this phase. Patients were 18 to 60 years old (mean 40 years) and 60% were male. The mean PANSS total score was 66 (range 33 to 124). The mean CGI-S score was 3.5 (mildly to moderately ill). Prior to the next phase, stabilization was required. Stabilization was defined as having all of the following for four



consecutive weeks: an outpatient status, PANSS total score  $\leq 80$ , CGI-S  $\leq 4$  (moderately ill), and CGISS score  $\leq 2$  (mildly suicidal) on Part 1 and  $\leq 5$  (minimally worsened) on Part 2; and a score of  $\leq 4$  on each of the following PANSS items: conceptual disorganization, suspiciousness, hallucinatory behavior, and unusual thought content.

- A minimum 12-week uncontrolled, single-blind Abilify Maintena stabilization phase (treatment with 400 mg of Abilify Maintena given every 4 weeks in conjunction with oral aripiprazole [10 mg to 20 mg/day] for the first 2 weeks). The dose of ABILIFY MAINTENA may have been decreased to 300 mg due to adverse reactions. A total of 576 patients entered this phase. The mean PANSS total score was 59 (range 30 to 80) and the mean CGI-S score was 3.2 (mildly ill). Prior to the next phase, stabilization was required (see above for the definition of stabilization) for 12 consecutive weeks.
- A double-blind, placebo-controlled randomized-withdrawal phase to observe for relapse (defined below). A total of 403 patients were randomized 2:1 to the same dose of Abilify Maintena they were receiving at the end of the stabilization phase, (400 mg or 300 mg administered once every 4 weeks) or placebo. Patients had a mean PANSS total score of 55 (range 31 to 80) and a CGI-S score of 2.9 (mildly ill) at entry. The dose could be adjusted up and down or down and up within the range of 300 to 400 mg on a one-time basis.

The primary efficacy endpoint was time from randomization to relapse. Relapse was defined as the first occurrence of one or more of the following criteria:

- CGI-I of  $\geq 5$  (minimally worse) and
  1. an increase on any of the following individual PANSS items (conceptual disorganization, hallucinatory behavior, suspiciousness, unusual thought content) to a score  $>4$  with an absolute increase of  $\geq 2$  on that specific item since randomization or
  2. an increase on any of the following individual PANSS items (conceptual disorganization, hallucinatory behavior, suspiciousness, unusual thought content) to a score  $>4$  and an absolute increase  $\geq 4$  on the combined four PANSS items (conceptual disorganization, hallucinatory behavior, suspiciousness, unusual thought content) since randomization
- Hospitalization due to worsening of psychotic symptoms (including partial hospitalization), but excluding hospitalization for psychosocial reasons
- CGI-SS of 4 (severely suicidal) or 5 (attempted suicide) on Part 1 and/or 6 (much worse) or 7 (very much worse) on Part 2, or
- Violent behavior resulting in clinically significant self-injury, injury to another person, or property damage.

A pre-planned interim analysis demonstrated a statistically significantly longer time to relapse in patients randomized to the Abilify Maintena group compared to placebo-treated patients and the trial was subsequently terminated early because maintenance of efficacy was demonstrated. The final analysis demonstrated a statistically significantly longer time to relapse in patients randomized to the Abilify Maintena group than compared to placebo-treated patients. The Kaplan-Meier curves of the cumulative proportion of patients with relapse during the double-blind treatment phase for Abilify Maintena and placebo groups are shown in Figure 17.

**Figure 17: Kaplan-Meier Estimation of Cumulative Proportion of Abilify Maintena-Treated Patients with Relapse\* (Adults) Study 2**

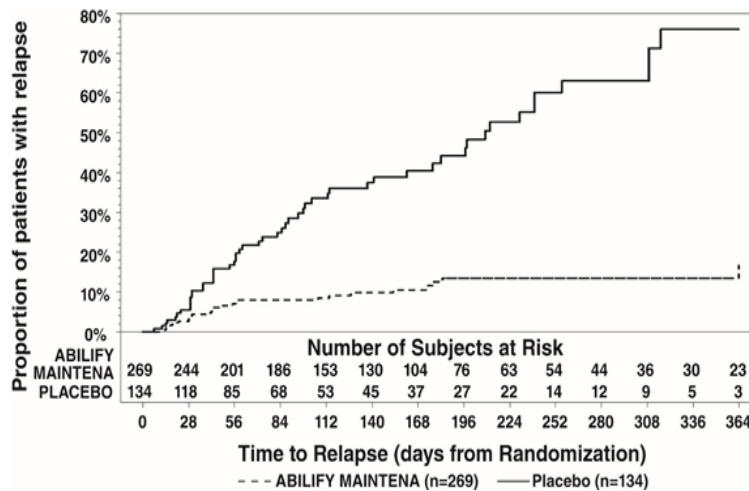

\*This figure is based on a total of 80 relapse events.

The key secondary efficacy endpoint, percentage of patients meeting the relapse criteria, was statistically significantly lower in patients randomized to the Abilify Maintena group (10%) than in the placebo group (40%).

#### 14.2 Bipolar I Disorder - Maintenance Monotherapy

The efficacy of ABILIFY ASIMTUFII (once every 2 month dosing) for the treatment of maintenance monotherapy treatment of bipolar I disorder in adults is based on an adequate and well-controlled study of Abilify Maintena (once monthly dosing). The results of the adequate and well-controlled study are presented below.

The efficacy of Abilify Maintena (once monthly dosing) for the maintenance treatment of bipolar I disorder was established in a 52-week, double-blind, placebo-controlled, randomized withdrawal trial in adult patients who were experiencing a manic episode at trial entry, met DSM-IV-TR criteria for bipolar I disorder, and had a history of at least one previous manic or mixed episode with manic symptoms of sufficient severity to require one of the following interventions: hospitalization and/or treatment with a mood stabilizer, and/or treatment with an antipsychotic agent.

Clinical ratings during this trial included:

Young Mania Rating Scale (YMRS)-an 11-item, clinician-rated scale used to assess the degree of manic symptomatology, in a range with 0 representing no symptoms, and 60 representing worst symptoms; Montgomery-Asberg Depression Rating Scale (MADRS) – a 10-item clinician-related scale used to assess the degree of depressive symptomatology, with 1 representing no symptoms, and 60 representing worst symptoms; Clinical Global Impression Bipolar Version Severity of Illness (CGI-BP-S) a scale of 1 (normal, not at all ill) to 7 (very severely ill patient) based on the patient’s severity of illness mania, depression, and overall bipolar illness.

This trial included:

- A 4 to 6 week, open-label, oral conversion phase for patients on treatments for bipolar I disorder other than aripiprazole. A total of 466 patients entered this phase.
- A 2 to 8 week, open-label, oral aripiprazole stabilization phase (target dose of 15 mg to 30 mg once daily). A total of 632 patients entered this phase. Patients were 18 to

65 years old (mean 40.7 years) and 60% were female. The mean (range) baseline scores were: YMRS total, 16.9 MADRS total, 5.7, and CGI-BP-S overall, 3.4 (mildly to moderately ill). Prior to the next phase, stabilization was required. Stabilization was defined as having all of the following at one bi-weekly visit: Outpatient status, YMRS total score  $\leq 12$ , MADRS total score  $\leq 12$  no active suicidality; with active suicidality defined as a score of 4 or more on the MADRS item 10 OR an answer of “yes” on question 4 or 5 on the Columbia Suicide Severity Rating Scale (C-SSRS).

- A minimum 12-week, uncontrolled, single-blind Abilify Maintena stabilization phase (treatment with 400 mg of Abilify Maintena given every 4 weeks in conjunction with oral aripiprazole [10 mg to 20 mg/day] for the first 2 weeks). The dose of Abilify Maintena was allowed to be decreased to 300 mg due to adverse reactions. A total of 425 patients entered this phase. The mean (range) baseline scores were: YMRS total, 5.8, MADRS total 3.7, and CGI-BP-S overall, 2.1 (minimally ill). Prior to the next phase, stabilization was required (see above for the definition of stabilization) for 8 consecutive weeks starting at week 6.
- A double-blind, placebo-controlled, randomized-withdrawal phase to observe for recurrence to a mood episode (defined below) for up to 52 weeks. A total of 266 patients were randomized 1:1 to the same dose of Abilify Maintena they were receiving at the end of the stabilization phase, (400 mg or 300 mg administered once every 4 weeks) or placebo. The mean (range) baseline scores were: YMRS total, 2.8 (0 to 12), MADRS total, 2.7 (0 to 12), and CGI-S overall, 1.7 (minimally ill). The dose could be decreased to 300 mg for tolerability and returned once to 400 mg.

The primary efficacy endpoint was time from randomization to recurrence of any mood episode. Recurrence was defined as the first occurrence of one or more of the following criteria:

1) Hospitalization for any mood episode OR 2) Any of the following: a. YMRS total score  $\geq 15$  OR b. MADRS total score  $\geq 15$  OR c. Clinical Global Impression - Bipolar Version-Severity (CGI-BP-S) score  $>4$  (overall score) OR 3) Serious adverse event (SAE) of worsening disease (bipolar I disorder) OR 4) Discontinuation due to lack of efficacy or discontinuation due to an adverse event (AE) of worsening disease OR 5) Clinical worsening with the need for addition of a mood stabilizer, antidepressant treatment, antipsychotic medication, and/or increase greater than the allowed benzodiazepine doses for treatment of symptoms of an underlying mood disorder OR 6) Active suicidality, which is defined as a score of 4 or more on the MADRS item 10 OR an answer of “yes” on question 4 or 5 on the C-SSRS

Analysis demonstrated a statistically significantly longer time to recurrence of any mood episode in subjects randomized to the Abilify Maintena group than compared to placebo-treated subjects. The Kaplan-Meier curves of the time of recurrence to any mood episode during the double-blind treatment phase for Abilify Maintena and placebo groups are shown in Figure 18.

**Figure 18: Kaplan-Meier Estimation of Cumulative Recurrence Rate for Any Mood Episode\* in Abilify Maintena-Treated Adults**

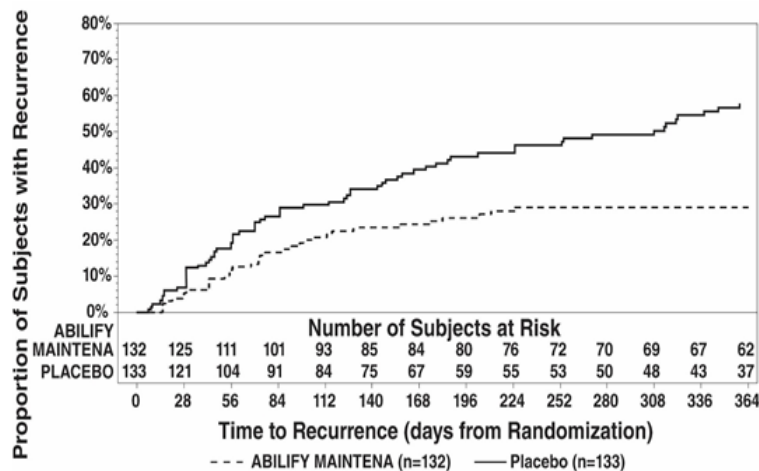

\*This figure is based on a total of 103 recurrence events.

Analysis by type of mood recurrence demonstrated a statistically significantly longer time to recurrence for both manic and mixed mood episodes in subjects treated with Abilify Maintena compared to those treated with placebo. There was no substantial difference between treatment groups in delaying time to recurrence of depressive mood episodes.

An examination of subgroups did not reveal any clear evidence of differential responsiveness on the basis of age, sex, or race.

## 16 HOW SUPPLIED/STORAGE AND HANDLING

### How Supplied

ABILIFY ASIMTUFII (aripiprazole) is available as white to off-white, sterile aqueous extended-release injectable suspension in single-dose, pre-filled syringes in 720 mg/2.4 mL or 960 mg/3.2 mL strengths.

The single-use kit contains 1 pre-filled syringe and 2 safety needles (a 1.5 inch 22 gauge needle and a 2 inch 21 gauge needle).

- 720 mg aripiprazole kit with aqua colored syringe tip wrap (NDC 59148-102102-80)
- 960 mg aripiprazole kit with light blue colored syringe tip wrap (NDC 59148-114114-80)

### Storage

Store at 25°C (77°F), excursions permitted between 15° and 30°C (59° to 86°F) [see USP Controlled Room Temperature].

## 17 PATIENT COUNSELING INFORMATION

Advise the patient to read the FDA-approved patient labeling ([Medication Guide](#))

### Neuroleptic Malignant Syndrome

Counsel patients about a potentially fatal adverse reaction, Neuroleptic Malignant Syndrome (NMS) that has been reported in association with administration of antipsychotic drugs. Advise patients, family members, or caregivers to contact a health care provider or report to the emergency room if they experience signs and symptoms of NMS [see *Warnings and Precautions* (5.3)].

### Tardive Dyskinesia

Counsel patients on the signs and symptoms of tardive dyskinesia and to contact their health care provider if these abnormal movements occur [see *Warnings and Precautions* (5.4)].

### Metabolic Changes

Educate patients about the risk of metabolic changes, how to recognize symptoms of hyperglycemia and diabetes mellitus, and the need for specific monitoring, including blood glucose, lipids, and weight [see *Warnings and Precautions* (5.5)].

### Pathological Gambling and Other Compulsive Behaviors

Advise patients and their caregivers of the possibility that they may experience compulsive urges to shop, increased urges to gamble, compulsive sexual urges, binge eating and/or other compulsive urges and the inability to control these urges while taking ABILIFY ASIMTUFII. In some cases, but not all, the urges were reported to have stopped when the dose was reduced or stopped [see *Warnings and Precautions* (5.6)].

### Orthostatic Hypotension and Syncope

Educate patients about the risk of orthostatic hypotension and syncope, especially early in treatment, and also at times of re-initiating treatment or increases in dosage [see *Warnings and Precautions* (5.7)].

### Leukopenia/Neutropenia

Advise patients with a pre-existing low WBC count or a history of drug-induced leucopenia/neutropenia that they should have their CBC monitored while receiving ABILIFY ASIMTUFII [see *Warnings and Precautions* (5.9)].

### Potential for Cognitive and Motor Impairment

Inform patients that ABILIFY ASIMTUFII has the potential to impair judgment, thinking, or motor skills. Caution patients about performing activities requiring mental alertness, such as operating hazardous machinery or operating a motor vehicle, until they are reasonably certain that ABILIFY ASIMTUFII therapy does not affect them adversely [see *Warnings and Precautions* (5.11)].

### Heat Exposure and Dehydration

Educate patients regarding appropriate care in avoiding overheating and dehydration [see *Warnings and Precautions* (5.12)].

### Concomitant Medication

Advise patients to inform their health care providers of any changes to their current prescription or over-the-counter medications because there is a potential for clinically significant interactions [see *Drug Interactions* (7.1)].

### Pregnancy

Advise patients that ABILIFY ASIMTUFII may cause extrapyramidal and/or withdrawal symptoms in a neonate and to notify their healthcare provider with a known or suspected pregnancy. Advise patients that there is a pregnancy exposure registry that monitors pregnancy outcomes in women exposed to ABILIFY ASIMTUFII during pregnancy [see *Use in Specific Populations* (8.1)].

Distributed and marketed by Otsuka America Pharmaceutical, Inc., Rockville, MD 20850 USA

Marketed by Lundbeck, Deerfield, IL 60015 USA

ABILIFY ASIMTUFII is a trademark of Otsuka Pharmaceutical Co., Ltd.

©2023, Otsuka Pharmaceutical Co., Ltd., 2-9 Kanda-Tsukasamachi, Chiyoda-ku, Tokyo,  
101-8535 Japan

**MEDICATION GUIDE**  
**ABILIFY ASIMTUFII® (a-BIL-i-fy AH-SIM-TUH-FYE)**  
**(aripiprazole) for extended-release injectable suspension, for intramuscular use**

**What is the most important information I should know about ABILIFY ASIMTUFII?**

**ABILIFY ASIMTUFII may cause serious side effects, including:**

- **Increased risk of death in elderly people with dementia-related psychosis.** ABILIFY ASIMTUFII increases the risk of death in elderly people who have lost touch with reality (psychosis) due to confusion and memory loss (dementia). ABILIFY ASIMTUFII is not for the treatment of people with dementia-related psychosis.

**What is ABILIFY ASIMTUFII?**

ABILIFY ASIMTUFII is a prescription medicine given by injection by a healthcare provider:

- for the treatment of schizophrenia in adults
- alone as maintenance treatment of bipolar I disorder in adults

It is not known if ABILIFY ASIMTUFII is safe and effective in children under 18 years of age.

**Do not receive ABILIFY ASIMTUFII if you** are allergic to aripiprazole or any of the ingredients in ABILIFY ASIMTUFII. See the end of this Medication Guide for a complete list of ingredients in ABILIFY ASIMTUFII.

**Before receiving ABILIFY ASIMTUFII, tell your healthcare provider about all of your medical conditions, including if you:**

- have never taken aripiprazole before
- have or had diabetes or high blood sugar or a family history of diabetes or high blood sugar. Your healthcare provider should check your blood sugar before you start receiving ABILIFY ASIMTUFII and during your treatment with ABILIFY ASIMTUFII.
- have or had high levels of total cholesterol, LDL cholesterol, or triglycerides, or low levels of HDL cholesterol
- have or had low or high blood pressure
- have or had heart problems or a stroke
- have or had a low white blood cell count
- have or had seizures (convulsions)
- have problems that may affect you receiving an injection in your buttocks
- are pregnant or plan to become pregnant. ABILIFY ASIMTUFII may harm your unborn baby. Receiving ABILIFY ASIMTUFII during your third trimester of pregnancy may cause your baby to have abnormal muscle movements or withdrawal symptoms after birth. Talk to your healthcare provider about the risk to your unborn baby if you receive ABILIFY ASIMTUFII during pregnancy.
  - Tell your healthcare provider right away if you become pregnant or think that you are pregnant during treatment with ABILIFY ASIMTUFII.
  - If you become pregnant during treatment with ABILIFY ASIMTUFII, talk to your healthcare provider about registering with the National Pregnancy Registry for Atypical Antipsychotics. You can register by calling 1-866-961-2388 or visit <http://womensmentalhealth.org/clinical-and-research-programs/pregnancyregistry/>.
- are breastfeeding or plan to breastfeed. ABILIFY ASIMTUFII can pass into your breast milk and it is not known if it may harm your baby. Talk to your healthcare provider about the best way to feed your baby during treatment with ABILIFY ASIMTUFII.

**Tell your healthcare provider about all the medicines you take**, including prescription medicines and over-the-counter medicines, vitamins, and herbal supplements.

ABILIFY ASIMTUFII and other medicines may affect each other causing possible serious side effects. ABILIFY ASIMTUFII may affect the way other medicines work, and other medicines may affect how ABILIFY ASIMTUFII works.

Your healthcare provider can tell you if it is safe to receive ABILIFY ASIMTUFII with your other medicines. Do not start or stop any medicines during treatment with ABILIFY ASIMTUFII without first talking to your healthcare provider.

Know the medicines you take. Keep a list of them to show your healthcare provider and pharmacist when you get a new medicine.

**How should I receive ABILIFY ASIMTUFII?**

- Follow your ABILIFY ASIMTUFII treatment schedule exactly as your healthcare provider tells you to.
- Your healthcare provider will tell you how much ABILIFY ASIMTUFII you will receive and when you will receive it.
- ABILIFY ASIMTUFII is an injection given only in your buttock by your healthcare provider 1 time every 2 months.

- After your first injection of ABILIFY ASIMTUFII, you should continue to take your current antipsychotic medicine by mouth for 2 weeks.
- You should not miss a dose of ABILIFY ASIMTUFII. If you miss a dose for some reason, call your healthcare provider right away to discuss what you should do next.

#### What should I avoid while receiving ABILIFY ASIMTUFII?

- **Do not** drive a car, operate machinery, or do other dangerous activities until you know how ABILIFY ASIMTUFII affects you. ABILIFY ASIMTUFII may affect your judgement, thinking or motor skills.
- **Do not** drink alcohol during treatment with ABILIFY ASIMTUFII.
- **Do not** become too hot or dehydrated during treatment with ABILIFY ASIMTUFII.
  - **Do not** exercise too much.
  - In hot weather, stay inside in a cool place if possible.
  - Stay out of the sun.
  - **Do not** wear too much clothing or heavy clothing.
  - Drink plenty of water.

#### What are the possible side effects of ABILIFY ASIMTUFII?

##### ABILIFY ASIMTUFII may cause serious side effects, including:

- See "What is the most important information I should know about ABILIFY ASIMTUFII?"
- **Stroke, (cerebrovascular problems) in elderly people with dementia-related psychosis that can lead to death.**
- **Neuroleptic malignant syndrome (NMS), a serious condition that can lead to death.** Call your healthcare provider or go to the nearest emergency room right away if you have some or all of the following signs and symptoms of NMS:
  - high fever
  - confusion
  - changes in pulse, heart rate, and blood pressure
  - stiff muscles
  - increased sweating
- **Uncontrolled body movements (tardive dyskinesia).** ABILIFY ASIMTUFII may cause movements that you cannot control in your face, tongue, or other body parts. Tardive dyskinesia may not go away, even if you stop receiving ABILIFY ASIMTUFII. Tardive dyskinesia may also start after you stop receiving ABILIFY ASIMTUFII.
- **Problems with your metabolism such as:**
  - **high blood sugar (hyperglycemia) and diabetes:** Increases in blood sugar can happen in some people who are treated with ABILIFY ASIMTUFII. Extremely high blood sugar can lead to coma or death. If you have diabetes or risk factors for diabetes such as being overweight, or a family history of diabetes, your healthcare provider should check your blood sugar before you start treatment with ABILIFY ASIMTUFII, and during treatment with ABILIFY ASIMTUFII.
 

**Call your healthcare provider if you have any of these symptoms of high blood sugar during treatment with ABILIFY ASIMTUFII:**

    - feel very thirsty
    - feel very hungry
    - feel sick to your stomach
    - need to urinate more than usual
    - feel weak or tired
    - feel confused, or your breath smells fruity
  - **Increased fat levels (cholesterol and triglycerides) in your blood.**
  - **Weight gain.** You and your healthcare provider should check your weight regularly during treatment with ABILIFY ASIMTUFII.
- **Unusual and uncontrollable (compulsive) urges.** Some people receiving ABILIFY ASIMTUFII have had unusual strong urges to gamble and gambling that cannot be controlled (compulsive gambling). Other compulsive urges including sexual urges, shopping, and eating or binge eating. If you or your family members notice that you are having unusual urges or behaviors, talk to your healthcare provider.
- **Decreased blood pressure (orthostatic hypotension).** You may feel lightheaded or faint when you rise too quickly from a sitting or lying position.
- **Falls.** ABILIFY ASIMTUFII may make you sleepy or dizzy, may cause a decrease in your blood pressure when changing position (orthostatic hypotension), and can slow your thinking and motor skills which may lead to falls that can cause fractures or other injuries.



- **Low white blood cell count.** Your healthcare provider may do blood tests during your first few months of treatment with ABILIFY ASIMTUFII.
- **Seizures (convulsions)**
- **Sleepiness, drowsiness, feeling tired, difficulty thinking and doing normal activities.** See "What should I avoid while receiving ABILIFY ASIMTUFII?"
- **Problems controlling your body temperature so that you feel too warm.** See "What should I avoid while receiving ABILIFY ASIMTUFII?"
- **Difficulty swallowing** that can cause food or liquid to get into your lungs.

**The most common side effects of ABILIFY ASIMTUFII include:** weight gain, restlessness or feeling like you need to move (akathisia), injection site pain, or sleepiness (sedation).

These are not all the possible side effects of ABILIFY ASIMTUFII.

Call your doctor for medical advice about side effects. You may report side effects to FDA at 1-800-FDA-1088.

#### **General information about the safe and effective use of ABILIFY ASIMTUFII.**

If you would like more information, talk with your healthcare provider. You can ask your pharmacist or healthcare provider for information about ABILIFY ASIMTUFII that is written for healthcare professionals.

#### **What are the ingredients in ABILIFY ASIMTUFII?**

**Active ingredient:** aripiprazole monohydrate

**Inactive ingredients:** carboxymethylcellulose sodium, polyethylene glycol 400, povidone, sodium chloride, sodium phosphate monobasic monohydrate, sodium hydroxide and water for injection.

ABILIFY ASIMTUFII is a trademark of Otsuka Pharmaceutical Co., Ltd.

© 2023, Otsuka Pharmaceutical Co., Ltd., 2-9 Kanda-Tsukasamachi, Chiyoda-ku, Tokyo, 101-8535 Japan

For more information about ABILIFY ASIMTUFII, go to [www.ABILIFY.com](http://www.ABILIFY.com) or call 1-800-441-6763.

This Medication Guide has been approved by the U.S. Food and Drug Administration.

Issued: 4/2023

## INSTRUCTIONS FOR USE

### ABILIFY ASIMTUFII (a-BIL-i-fy AH-SIM-TUH-FYE)

(aripiprazole)

#### extended-release injectable suspension

The following information is intended for medical or healthcare professionals only and should be read by the medical or healthcare professional in conjunction with the full prescribing information.

- Read the complete instructions for preparation and administration below before administering ABILIFY ASIMTUFII.
- To be prepared and administered only by a healthcare professional once every two months.
- ABILIFY ASIMTUFII pre-filled syringe is **single-dose only**. Re-use may lead to infection or other illness/injury.
- For gluteal intramuscular injection only. Do not administer by any other route.
- Prior to administration, visually inspect ABILIFY ASIMTUFII pre-filled syringe for particulate matter and discoloration. The suspension should appear to be a uniform, homogeneous suspension that is opaque and milky-white in color. Do not use ABILIFY ASIMTUFII pre-filled syringe if the suspension is discolored, or particulate matter is present.

#### Contents of Kit

Each kit contains one sterile pre-filled syringe containing ABILIFY ASIMTUFII (aripiprazole) 720 mg or 960 mg extended-release injectable suspension and two safety needles:

- One sterile 1 ½ inch 22 gauge needle (in black packaging)
- One sterile 2 inch 21 gauge needle (in green packaging)

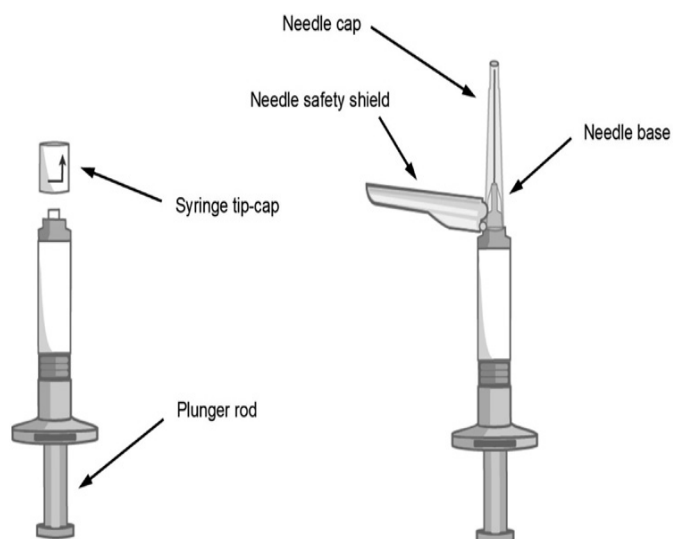

#### Preparation Prior to Administration

- Remove the ABILIFY ASIMTUFII pre-filled syringe from the package.
- Tap the syringe on your hand at least 10 (ten) times (Figure 1).

- After tapping, shake the syringe vigorously for at least 10 (ten) seconds until the medication is uniform (Figure 2).

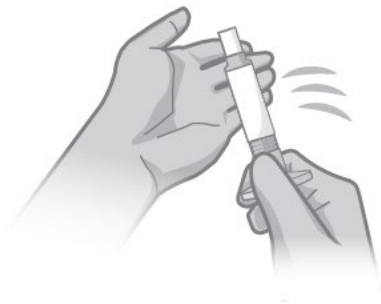

**Figure 1**

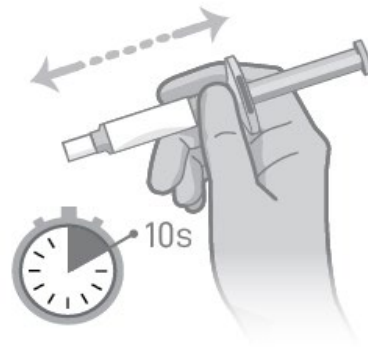

**Figure 2**

Select the appropriate needle

Needle selection is determined by patient body type.

**For gluteal intramuscular administration only.**

- For non-obese patients - 22-gauge, 1.5-inch (38 mm) safety needle with needle protection device (needle in black packaging)
- For obese patients - 21-gauge, 2-inch (51 mm) safety needle with needle protection device (needle in green packaging)

Refer to Table 1 below for needle information:

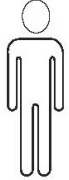
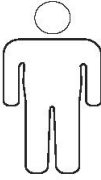
<b>Table 1: Needle Size Required by Body Type</b>		
<b>Body Type</b>	<b>Needle Size</b>	<b>Needle Packaging Color</b>
 <p><b>Non-obese</b></p>	1 ½ inch, 22 gauge	black
 <p><b>Obese</b></p>	2 inch, 21 gauge	green

Attach the needle

- Twist and pull off the pre-filled syringe tip-cap (Figure 3).
- While holding the base of the needle, ensure the needle is firmly seated on the safety device with a push. Gently twist clockwise until SECURELY fitted (Figure 3).

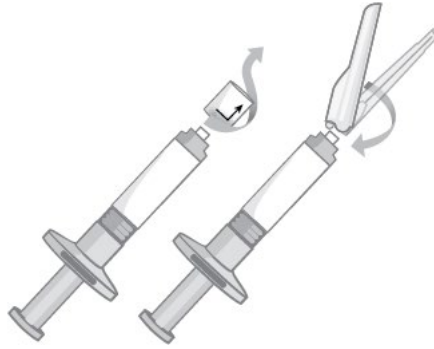

**Figure 3**

Expel Air

- When you are ready to administer the injection of ABILIFY ASIMTUFII, hold the pre-filled syringe upright and remove the needle-cap straight up (Figure 4). Do not twist the needle-cap, as this may loosen the needle from the syringe.

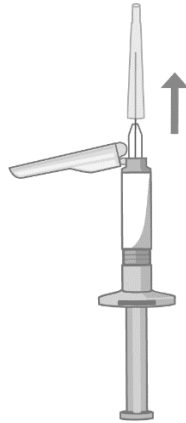

**Figure 4**

- Slowly advance the plunger rod upward to expel the air and until the suspension fills needle base (Figure 5).



**Figure 5**

### Inject the dose

- Slowly inject the entire contents of the pre-filled syringe intramuscularly into the gluteal muscle of the patient (Figure 6).

**Do not administer by any other route.**

Do not massage the injection site.

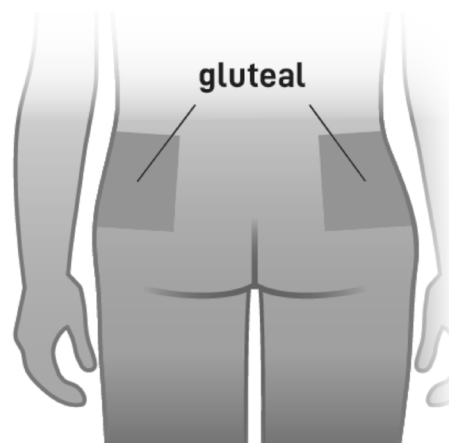

**Figure 6**

### Disposal Procedure

- After the injection, press the safety shield on a hard surface to cover and lock shield over the needle (Figure 7 and 8)

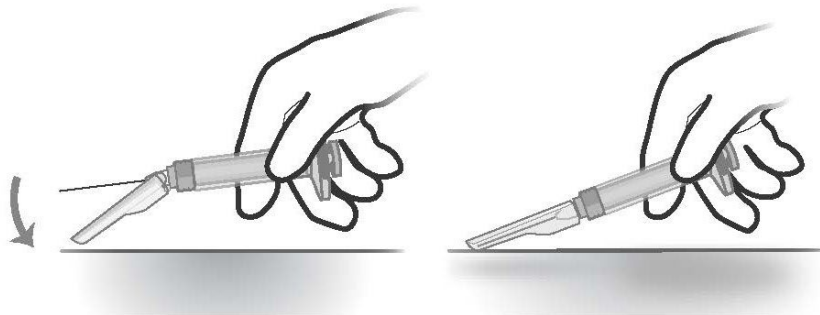

**Figure 7**

**Figure 8**

- Immediately discard used syringe and the unused needle in an approved sharps container (Figure 9).
- The unused needle should not be saved for future use.



**Figure 9**