

INSTRUCTIONS FOR USE
DUPIXENT® (DU-pix-ent)
(dupilumab)
injection, for subcutaneous use
Single-Dose Pre-filled Syringe with Needle Shield

Read this Instructions for Use before using the DUPIXENT Pre-filled Syringe. **Do not inject the child until you have been shown how to inject DUPIXENT.** Your healthcare provider can show you how to prepare and inject a dose of DUPIXENT before you try to do it yourself the first time. Keep these instructions for future use. Call your healthcare provider if you have any questions.

This device is a **Single-Dose** Pre-filled Syringe (called “DUPIXENT Syringe” in these instructions). It contains 100 mg of DUPIXENT for injection under the skin (subcutaneous injection).

The parts of the DUPIXENT Syringe are shown below:

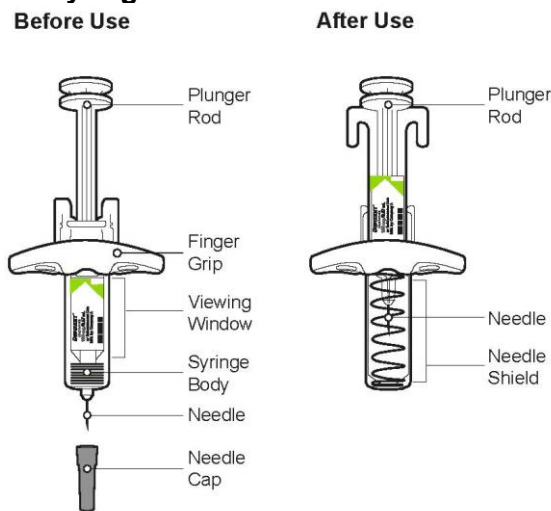

Important Information

- Read all of the instructions carefully before using the DUPIXENT Syringe.
- Ask your healthcare provider how often you will need to inject the medicine.
- **In children 6 months to less than 12 years of age**, DUPIXENT should be given by a caregiver.
- Rotate the injection site each time you inject.
- **Do not** use the DUPIXENT Syringe if it has been dropped on a hard surface or damaged.
- To reduce the risk of accidental needle sticks, each pre-filled syringe has a Needle Shield that is automatically activated to cover the needle after you have given the injection.
- **Do not** pull back on the Plunger Rod at any time.
- **Do not** remove the Needle Cap until just before you give the injection.
- Throw away (dispose of) the used DUPIXENT Single-Dose Pre-filled Syringe right away after use. See “Step 13: Dispose” below.

<ul style="list-style-type: none">• Do not use the DUPIXENT Syringe if the Needle Cap is missing or not securely attached.• Do not touch the Plunger Rod until you are ready to inject.• Do not inject through clothes.• Do not get rid of any air bubble in the DUPIXENT Syringe.	<ul style="list-style-type: none">• Do not re-use a DUPIXENT Single-Dose Pre-filled Syringe.
<p>How should I store DUPIXENT?</p> <ul style="list-style-type: none">• Keep DUPIXENT Syringes and all medicines out of the reach of children.• Store DUPIXENT Syringes in the refrigerator between 36°F to 46°F (2°C to 8°C).• Store DUPIXENT Syringes in the original carton to protect them from light.• DUPIXENT Syringes can be stored at room temperature up to 77°F (25°C) up to 14 days. Throw away (dispose of) any DUPIXENT Syringes that have been left at room temperature for longer than 14 days.• Do not shake the DUPIXENT Syringe.• Do not heat the DUPIXENT Syringe.• Do not freeze the DUPIXENT Syringe.• Do not put the DUPIXENT Syringe into direct sunlight.	

Step 1: Remove

Remove the DUPIXENT Syringe from the carton by holding the middle of the Syringe Body.



Do not pull off the Needle Cap until you are ready to inject.



Do not use the DUPIXENT Syringe if it has been dropped on a hard surface or damaged.

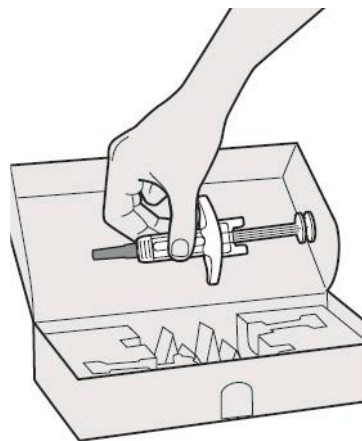

Step 2: Prepare

Ensure you have the following:

- the DUPIXENT Pre-filled Syringe
- 1 alcohol wipe*
- 1 cotton ball or gauze*

- a sharps disposal container* (See Step 13)
- *Items not included in the carton*



Step 3: Check

When you receive the DUPIXENT Syringes, always check to see that:

- you have the correct medicine and dose.
- the expiration date on the Single-Dose Pre-filled Syringe has not passed.



Do not use the DUPIXENT Syringe if the expiration date has passed.

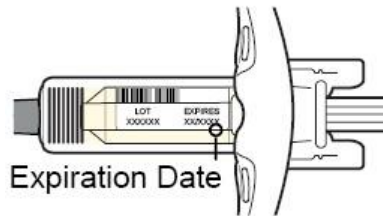

Step 4: Inspect

Look at the medicine through the Viewing Window on the DUPIXENT Syringe:

Check to see if the liquid is clear and colorless to pale yellow.

Note: You may see an air bubble, this is normal.



Do not use the DUPIXENT Syringe if the liquid is discolored or cloudy, or if it contains visible flakes or particles.

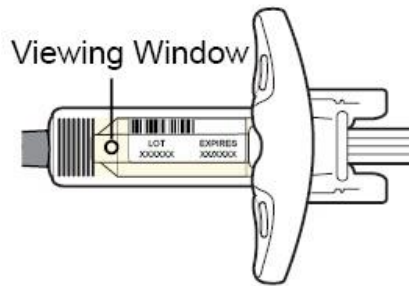

Step 5: Wait 30 minutes

Lay the DUPIXENT Syringe on a flat surface and let it naturally warm to room temperature for at least 30 minutes.



Do not heat the DUPIXENT Syringe.



Do not put the DUPIXENT Syringe into direct sunlight.



Do not keep DUPIXENT Syringes at room temperature for more than 14 days. Throw away (dispose of) any DUPIXENT Syringes that have been left at room temperature for longer than 14 days.

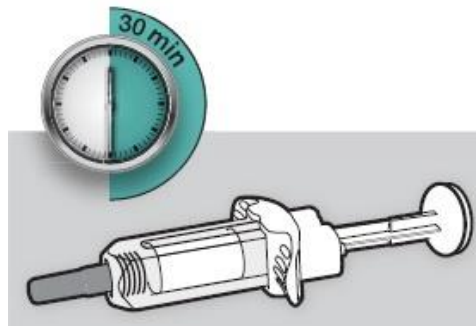

Step 6: Choose the injection site

- You can inject into the thigh, outer area of the upper arm or stomach, except for the 2 inches (5 cm) around the belly button (navel).
- Choose a different site each time you inject DUPIXENT.



Do not inject into skin that is tender, damaged, bruised or scarred.

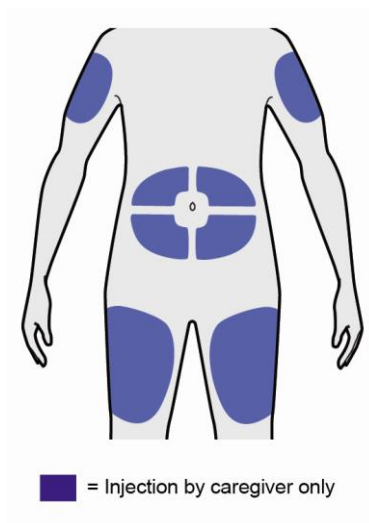

Step 7: Clean

Wash your hands.

Clean the injection site with an alcohol wipe.

Let the skin dry before injecting.

 **Do not touch the injection site again or blow on it before the injection.**



Step 8: Remove Needle Cap

Hold the DUPIXENT Syringe in the middle of the Syringe Body with the Needle pointing away from you and pull off the Needle Cap.

 **Do not put the Needle Cap back on.**

 **Do not touch the Needle.**

Inject the medicine right away after removing the Needle Cap.

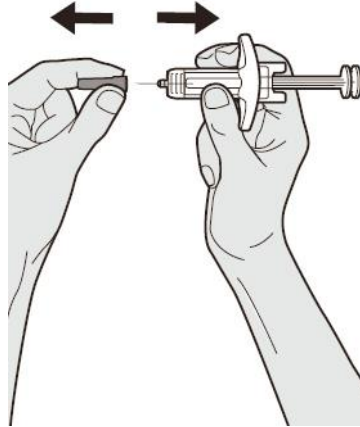

Step 9: Pinch

Pinch a fold of skin at the injection site (thigh or stomach, except 2 inches around the belly button, or outer area of the upper arm). The figure below shows an example of pinching a fold of skin on the stomach.

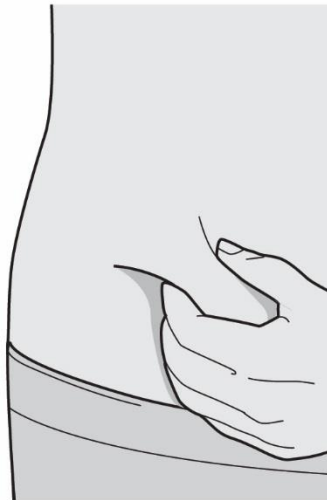

Step 10: Insert

Insert the Needle completely into the fold of the skin at about a 45° angle.

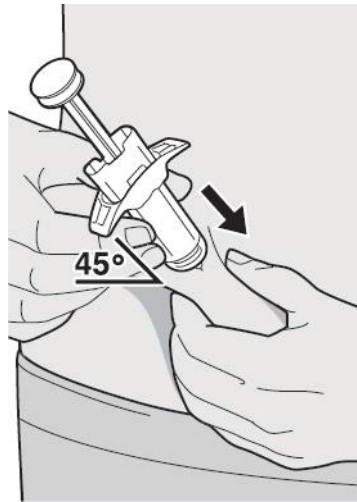

Step 11: Push

Relax the pinch.

Push the Plunger Rod down slowly and steadily as far as it will go until the DUPIXENT Syringe is empty.

Note: You will feel some resistance. This is normal.



Step 12: Release and Remove

Lift your thumb to release the Plunger Rod until the Needle is covered by the Needle Shield and then remove the Syringe from the injection site.

Lightly press a cotton ball or gauze on the injection site if you see any blood.

 **Do not put the Needle Cap back on.**

 **Do not rub the skin after the injection.**



Step 13: Dispose

Put used Needles, DUPIXENT Syringes, and Needle Caps in a FDA-cleared sharps disposal container right away after use.



Do not dispose of (throw away) Needles, DUPIXENT Syringes, and Needle Caps in your household trash.

If you do not have a FDA-cleared sharps disposal container, you may use a household container that is:

- made of a heavy-duty plastic,
- can be closed with a tight-fitting, puncture-resistant lid, without sharps being able to come out,
- upright and stable during use,
- leak-resistant, and
- properly labeled to warn of hazardous waste inside the container

When your sharps disposal container is almost full, you will need to follow your community guidelines for the right way to dispose of your sharps disposal container. There may be state or local laws about how you should throw away used Needles and Syringes.

For more information about safe sharps disposal, and for specific information about sharps disposal in the state that you live in, go to the FDA's website at:

<http://www.fda.gov/safesharpsdisposal>

Do not dispose of your used sharps disposal container in your household trash unless your community guidelines permit this. **Do not** recycle your used sharps disposal container.



Do not put the Needle Cap back on.

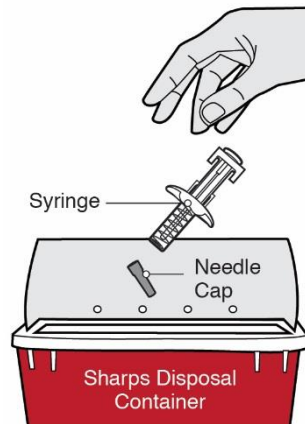

REGENERON sanofi

Manufactured by: Regeneron Pharmaceuticals, Inc. Tarrytown, NY 10591
U.S. License No. 1760

Marketed by: sanofi-aventis U.S. LLC (Bridgewater, NJ 08807) and Regeneron Pharmaceuticals, Inc. (Tarrytown, NY 10591)
DUPIXENT® is a registered trademark of Sanofi Biotechnology

© 2023 Regeneron Pharmaceuticals, Inc. / sanofi-aventis U.S. LLC. All rights reserved.

This Instructions for Use has been approved by the U.S. Food and Drug Administration.
Revised: July 2023

INSTRUCTIONS FOR USE
DUPIXENT® (DU-pix-ent)
(dupilumab)
injection, for subcutaneous use
Single-Dose Pre-filled Syringe with Needle Shield

Read this Instructions for Use before using the DUPIXENT Pre-filled Syringe. **Do not inject yourself or someone else until you have been shown how to inject DUPIXENT.** Your healthcare provider can show you or your caregiver how to prepare and inject a dose of DUPIXENT before you try to do it yourself the first time. Keep these instructions for future use. Call your healthcare provider if you have any questions.

This device is a **Single-Dose** Pre-filled Syringe (called “DUPIXENT Syringe” in these instructions). It contains 200 mg of DUPIXENT for injection under the skin (subcutaneous injection).

The parts of the DUPIXENT Syringe are shown below:

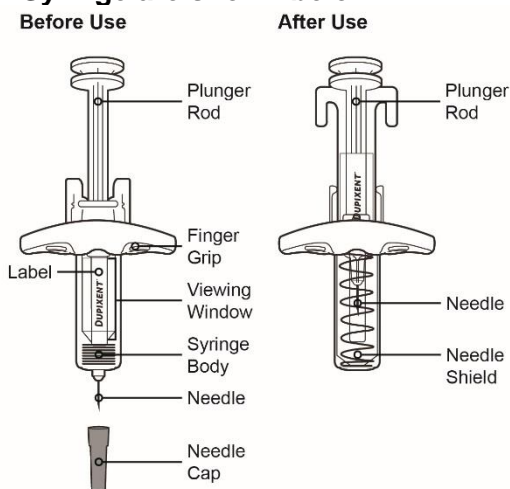

Important Information

- Read all of the instructions carefully before using the DUPIXENT Syringe.
- Ask your healthcare provider how often you will need to inject the medicine.
- **In children 12 years of age and older**, it is recommended that DUPIXENT be administered by or under supervision of an adult.
- **In children 6 months to less than 12 years of age**, DUPIXENT should be given by a caregiver.
- Rotate the injection site each time you inject.
- **Do not** use the DUPIXENT Syringe if it has been dropped on a hard surface or damaged.
- To reduce the risk of accidental needle sticks, each pre-filled syringe has a Needle Shield that is automatically activated to cover the needle after you have given your injection.
- **Do not** pull back on the Plunger Rod at any time.
- **Do not** remove the Needle Cap until just before you give the injection.
- Throw away (dispose of) the used DUPIXENT Single-Dose Pre-filled Syringe right away after use. See “Step 13: Dispose” below.
- **Do not re-use a DUPIXENT Single-Dose Pre-filled Syringe.**

- **Do not** use the DUPIXENT Syringe if the Needle Cap is missing or not securely attached.
- **Do not** touch the Plunger Rod until you are ready to inject.
- **Do not** inject through clothes.
- **Do not** get rid of any air bubble in the DUPIXENT Syringe.

How should I store DUPIXENT?

- **Keep DUPIXENT Syringes and all medicines out of the reach of children.**
- Store DUPIXENT Syringes in the refrigerator between 36°F to 46°F (2°C to 8°C).
- Store DUPIXENT Syringes in the original carton to protect them from light.
- DUPIXENT Syringes can be stored at room temperature up to 77°F (25°C) up to 14 days. Throw away (dispose of) any DUPIXENT Syringes that have been left at room temperature for longer than 14 days.
- **Do not** shake the DUPIXENT Syringe.
- **Do not** heat the DUPIXENT Syringe.
- **Do not** freeze the DUPIXENT Syringe.
- **Do not** put the DUPIXENT Syringe into direct sunlight.

Step 1: Remove

Remove the DUPIXENT Syringe from the carton by holding the middle of the Syringe Body.



Do not pull off the Needle Cap until you are ready to inject.



Do not use the DUPIXENT Syringe if it has been dropped on a hard surface or damaged.

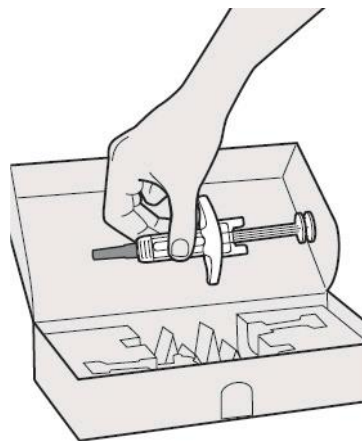

Step 2: Prepare

Ensure you have the following:

- the DUPIXENT Pre-filled Syringe
- 1 alcohol wipe*
- 1 cotton ball or gauze*

- a sharps disposal container* (See Step 13)

*Items not included in the carton



Step 3: Check

When you receive your DUPIXENT Syringes, always check to see that:

- you have the correct medicine and dose.
- the expiration date on the Single-Dose Pre-filled Syringe has not passed.



Do not use the DUPIXENT Syringe if the expiration date has passed.

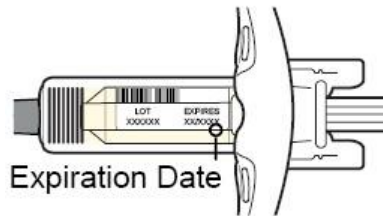

Step 4: Inspect

Look at the medicine through the Viewing Window on the DUPIXENT Syringe:

Check to see if the liquid is clear and colorless to pale yellow.

Note: You may see an air bubble, this is normal.



Do not use the DUPIXENT Syringe if the liquid is discolored or cloudy, or if it contains visible flakes or particles.

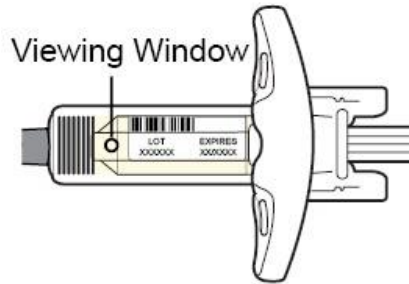

Step 5: Wait 30 minutes

Lay the DUPIXENT Syringe on a flat surface and let it naturally warm to room temperature for at least 30 minutes.



Do not heat the DUPIXENT Syringe.



Do not put the DUPIXENT Syringe into direct sunlight.



Do not keep DUPIXENT Syringes at room temperature for more than 14 days. Throw away (dispose of) any DUPIXENT Syringes that have been left at room temperature for longer than 14 days.

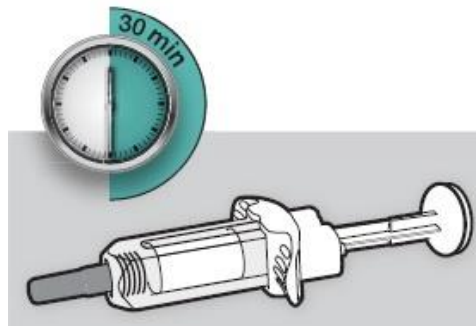



Step 6: Choose your injection site

- You can inject into your thigh or stomach, except for the 2 inches (5 cm) around your belly button (navel).
- If a caregiver injects your dose, they can also use the outer area of the upper arm.
- Choose a different site each time you inject DUPIXENT.

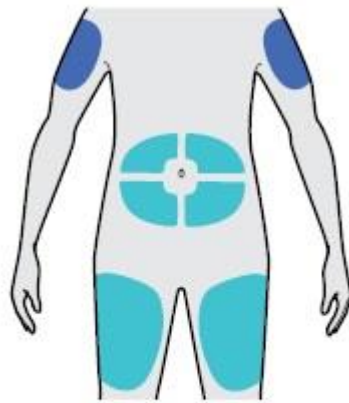

Do not inject into skin that is tender, damaged, bruised or scarred.



 = Self-injection or by caregiver
 = Injection by caregiver only

Step 7: Clean

Wash your hands.

Clean the injection site with an alcohol wipe.

Let your skin dry before injecting.

 **Do not touch the injection site again or blow on it before the injection.**



Step 8: Remove Needle Cap

Hold the DUPIXENT Syringe in the middle of the Syringe Body with the Needle pointing away from you and pull off the Needle Cap.

 **Do not put the Needle Cap back on.**

 **Do not touch the Needle.**

Inject your medicine right away after removing the Needle Cap.

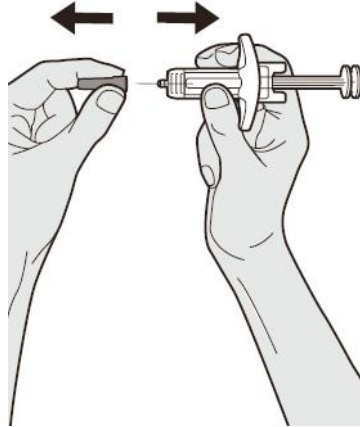

Step 9: Pinch

Pinch a fold of skin at the injection site (thigh or stomach, except 2 inches around your belly button, or outer area of the upper arm if injected by your caregiver). The figure below shows an example of pinching a fold of skin on your stomach.

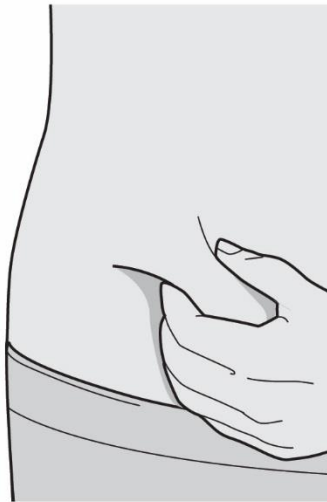

Step 10: Insert

Insert the Needle completely into the fold of the skin at about a 45° angle.

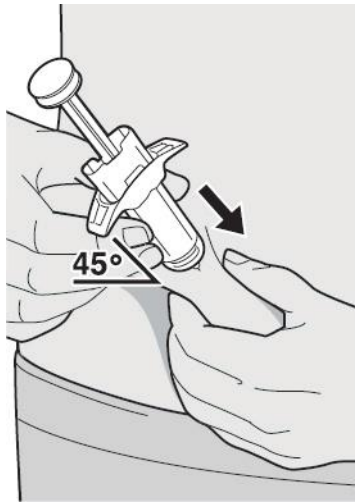

Step 11: Push

Relax the pinch.

Push the Plunger Rod down slowly and steadily as far as it will go until the DUPIXENT Syringe is empty.

Note: You will feel some resistance. This is normal.



Step 12: Release and Remove

Lift your thumb to release the Plunger Rod until the Needle is covered by the Needle Shield and then remove the Syringe from the injection site.

Lightly press a cotton ball or gauze on the injection site if you see any blood.



Do not put the Needle Cap back on.



Do not rub your skin after the injection.



Step 13: Dispose

Put your used Needles, DUPIXENT Syringes, and Needle Caps in a FDA-cleared sharps disposal container right away after use.



Do not dispose of (throw away) Needles, DUPIXENT Syringes, and Needle Caps in your household trash.

If you do not have a FDA-cleared sharps disposal container, you may use a household container that is:

- made of a heavy-duty plastic,
- can be closed with a tight-fitting, puncture-resistant lid, without sharps being able to come out,
- upright and stable during use,
- leak-resistant, and
- properly labeled to warn of hazardous waste inside the container

When your sharps disposal container is almost full, you will need to follow your community guidelines for the right way to dispose of your sharps disposal container. There may be state or local laws about how you should throw away used Needles and Syringes.

For more information about safe sharps disposal, and for specific information about sharps disposal in the state that you live in, go to the FDA's website at:

<http://www.fda.gov/safesharpsdisposal>

Do not dispose of your used sharps disposal container in your household trash unless your community guidelines permit this. **Do not** recycle your used sharps disposal container.



Do not put the Needle Cap back on.

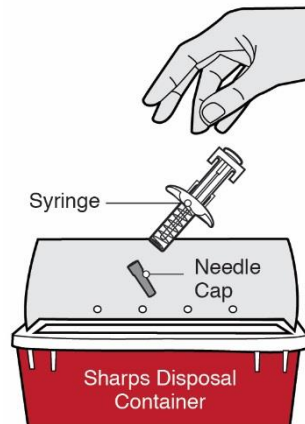

REGENERON sanofi

Manufactured by: Regeneron Pharmaceuticals, Inc. Tarrytown, NY 10591
U.S. License No. 1760

Marketed by: sanofi-aventis U.S. LLC (Bridgewater, NJ 08807) and Regeneron Pharmaceuticals, Inc. (Tarrytown, NY 10591)
DUPIXENT® is a registered trademark of Sanofi Biotechnology

© 2023 Regeneron Pharmaceuticals, Inc. / sanofi-aventis U.S. LLC. All rights reserved.

This Instructions for Use has been approved by the U.S. Food and Drug Administration.
Revised: July 2023

Instructions for Use
DUPIXENT® (DU-pix-ent)
(dupilumab)
injection, for subcutaneous use
Single-Dose Pre-filled Pen (200 mg/1.14 mL)

This Instructions for Use contains information on how to inject DUPIXENT.

Read this Instructions for Use before using the DUPIXENT Pre-filled Pen. **Do not inject yourself or someone else until you have been shown how to inject DUPIXENT.** Your healthcare provider can show you or your caregiver how to prepare and inject a dose of DUPIXENT before you try to do it yourself for the first time. Keep this Instructions for Use. Call your healthcare provider if you have any questions.

This DUPIXENT Pre-filled Pen is only for use in adults and children aged 2 years and older.

This DUPIXENT Pre-filled Pen is a single-dose device. It contains 200 mg of DUPIXENT for injection under the skin (subcutaneous injection).

The parts of the DUPIXENT Pre-filled Pen are shown below:

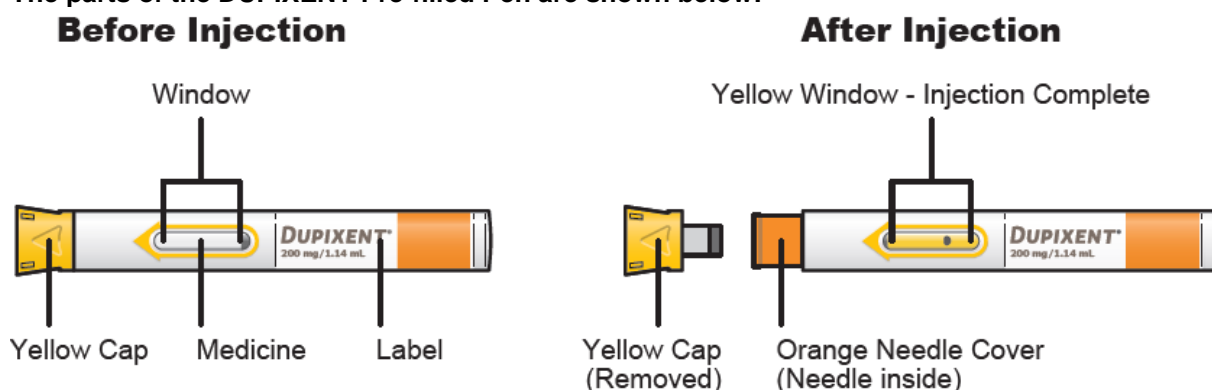

Important Information

- Read all of the instructions carefully before using the DUPIXENT Pre-filled Pen.
- Ask your healthcare provider how often you will need to inject the medicine.
- **In children 12 years of age and older**, it is recommended that DUPIXENT be administered by or under supervision of an adult.
- **In children 2 years to less than 12 years of age**, DUPIXENT should be given by a caregiver.
- Choose a different injection site for each injection.
- **Do not** press or touch the Orange Needle Cover with your fingers.
- **Do not** inject through clothes.
- **Do not** remove the Yellow Cap until just before you give the injection.
- **Do not** try to put the Yellow Cap back on the DUPIXENT Pre-filled Pen.
- Throw away (dispose of) the used DUPIXENT Pre-filled Pen right away after use.
- **Do not** re-use a DUPIXENT Pre-filled Pen.

Storing DUPIXENT

- Store unused DUPIXENT Pre-filled Pens in the refrigerator between 36°F to 46°F (2°C to 8°C).
- Store DUPIXENT Pre-filled Pens in the original carton to protect from light.
- If necessary, you may keep DUPIXENT Pre-filled Pens at room temperature up to 77°F (25°C) for up to **14 days**.
- **Do not** store DUPIXENT Pre-filled Pens at room temperature more than 77°F (25°C).
- After removing a DUPIXENT Pre-filled Pen from the refrigerator, it must be used within 14 days or thrown away (disposed of).
- **Do not** shake the DUPIXENT Pre-filled Pen at any time.
- **Do not** heat the DUPIXENT Pre-filled Pen.
- **Do not** freeze the DUPIXENT Pre-filled Pen.
- **Do not** put the DUPIXENT Pre-filled Pen into direct sunlight.
- **Keep DUPIXENT Pre-filled Pens and all medicines out of the reach of children.**

A. Get ready to inject

A1. Gather supplies

Find a clean, flat work surface.
Make sure you have the following supplies:



• DUPIXENT Pre-filled Pen



• 1 alcohol wipe*



• 1 cotton ball or gauze*



• a sharps disposal container* (See Step D)

* Items not included in the carton.

A2. Check the Pen

- **Do not** use the DUPIXENT Pre-filled Pen if it has been damaged.
- **Do not** use the DUPIXENT Pre-filled Pen if the Yellow Cap is missing or not securely attached.
- **Do not** use the DUPIXENT Pre-filled Pen if the Window is yellow before use.







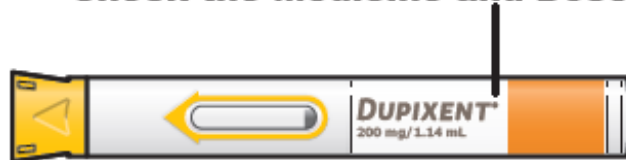

A3. Look at the Label

- Check to be sure that you have the correct Medicine and dose.

Check the Medicine and Dose



<ul style="list-style-type: none">• Check the expiration date.•  Do not use the DUPIXENT Pre-filled Pen if the expiration date has passed.	 <p>Check Expiration Date</p>
A4. Check the Medicine	
<ul style="list-style-type: none">• Look at the Medicine through the Window: it should be clear and colorless to pale yellow.• Note: You may see an air bubble, this is normal.•  Do not use the DUPIXENT Pre-filled Pen if the liquid is discolored or cloudy, or if it contains visible flakes or particles.	 <p>Check Window</p>
A5. Wait 30 minutes	
<ul style="list-style-type: none">• Lay the DUPIXENT Pre-filled Pen on a flat surface and let it warm up at room temperature less than 77°F (25°C) for at least 30 minutes.•  Do not heat the DUPIXENT Pre-filled Pen in a microwave, hot water or direct sunlight.	 <p>30 minutes</p>

B. Choose and prepare your injection site

B1. Wash your hands well with soap and water



B2. Choose an injection site

- **Thigh**
- **Stomach** except for the 2 inches (5 cm) around your belly button (navel).
- A caregiver can also inject in the outer area of the **upper arm**.
- Choose a different site for each injection.
- ⚠ **Do not** inject into skin that is tender, damaged, has bruises or scars, or into areas with visible veins.
- ⚠ **Do not** inject through clothes.

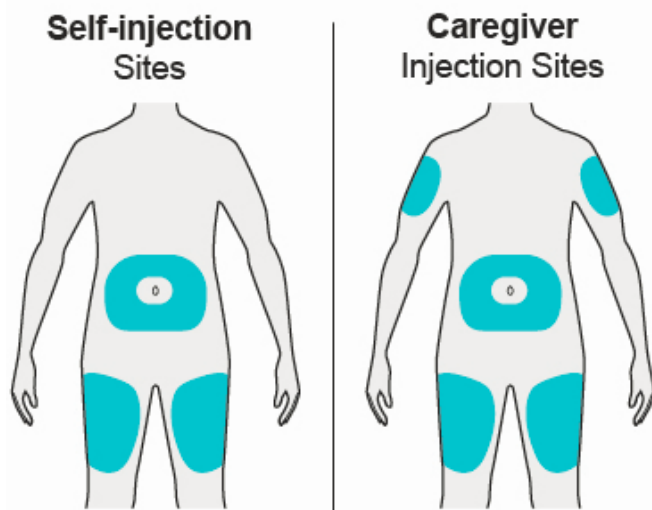

B3. Prepare the injection site

- Clean the injection site with an alcohol wipe.
- Let the skin dry before injecting.
-  **Do not** touch the injection site again or blow on it before the injection.

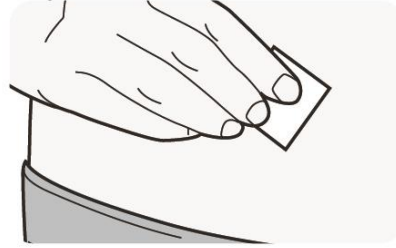

C. Give the injection

C1. Remove Yellow Cap

- Remove the Yellow Cap by pulling it straight off, as shown. **Do not** twist the Yellow Cap off.
- **Do not** remove the Yellow Cap until you are ready to inject.
- **Do not** press or touch the Orange Needle Cover with your fingers. The Needle is inside.
-  **Do not** put the Yellow Cap back on the DUPIXENT Pre-filled Pen after you have removed it.

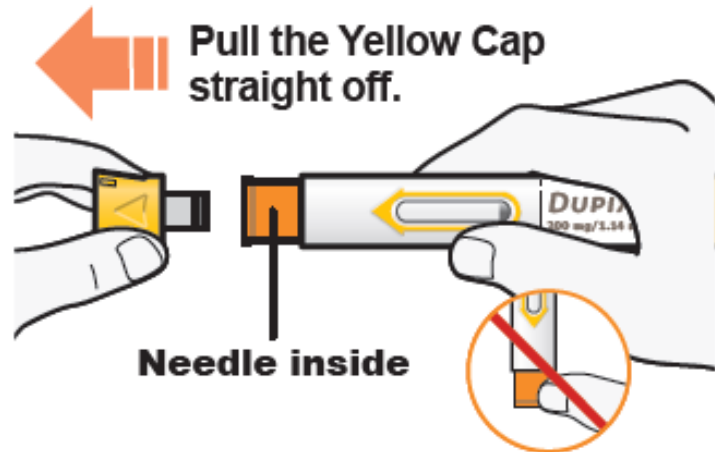

C2. Pinch Skin and Place

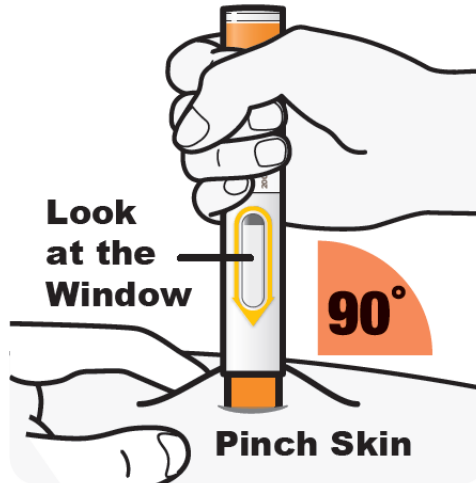

Pinch the skin before and during the injection.

- Hold the DUPIXENT Pre-filled Pen as shown so that you can see the Window. Place the Orange Needle Cover on the skin.
- Place the Orange Needle Cover on the skin at approximately a 90-degree angle.
- Pinching is not needed for adults and children aged 12 years and older.

C3. Press down → Watch Window turn fully yellow → Then count to 5



Press and hold the DUPIXENT Pre-filled Pen firmly against the skin **until you cannot see the Orange Needle Cover.**

- There will be a “click” when the injection starts, **and**
- The Window will start to turn yellow.
- **Keep pressing** the DUPIXENT Pre-filled Pen against the skin.



Keep pressing the DUPIXENT Pre-filled Pen against the skin and watch the window:

- The Window will turn completely yellow, **and**
- You will hear a **2nd “click”**.
- **Keep pressing** the DUPIXENT Pre-filled Pen against the skin.

Keep pressing the DUPIXENT Pre-filled Pen against the skin and **count to 5 to make sure you get your full dose.**

Pinching of the skin is not needed for adults and children aged 12 years and older.

C4. Remove

- After you have completed the injection pull straight up to remove DUPIXENT Pre-filled Pen from the skin. The Orange Needle Cover will cover the needle.
- If you see any blood at the site, lightly dab a cotton ball or gauze pad.
-  **Do not** rub the skin after the injection.
- If the Window does not turn completely Yellow, or if it looks like medicine is still coming out of the pen, you may not have received a full dose. Dispose of (throw away) the pen and contact your healthcare provider right away.
-  **Do not** give a second dose without speaking to your healthcare provider.

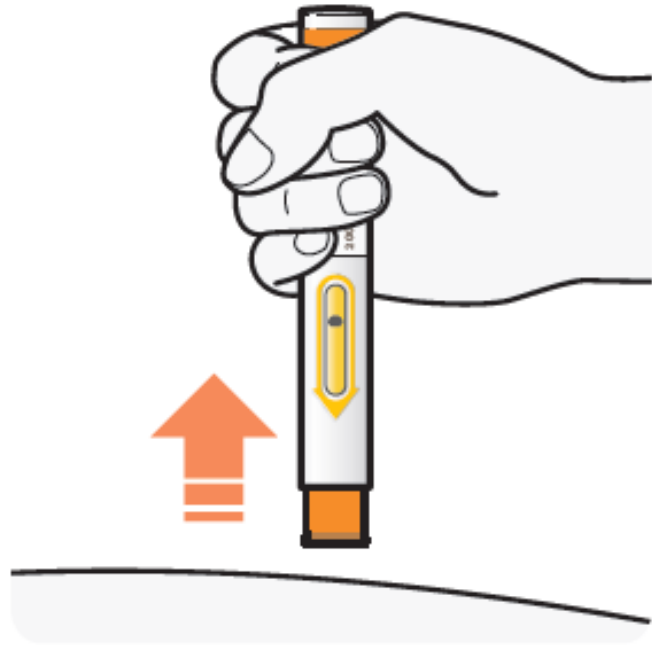

D. Dispose of used DUPIXENT Pre-filled Pen

How to Dispose of (throw away) DUPIXENT Pre-filled Pen:

Put the used DUPIXENT Pre-filled Pens and Yellow Caps in a FDA-cleared sharps disposal container right away after use.

⚠ Do not dispose of (throw away) DUPIXENT Pre-filled Pens and Yellow Caps in your household trash.

If you do not have a FDA-cleared sharps disposal container, you may use a household container that is:

- made of a heavy-duty plastic,
- can be closed with a tightfitting, puncture-resistant lid, without sharps being able to come out,
- upright and stable during use,
- leak-resistant, and
- properly labeled to warn of hazardous waste inside the container.

When your sharps disposal container is almost full, you will need to follow your community guidelines for the right way to dispose of your sharps disposal container. There may be state or local laws about how you should throw away used DUPIXENT Pre-filled Pens.

For more information about safe sharps disposal, and for specific information about sharps disposal in the state that you live in, go to the FDA's website at: <http://www.fda.gov/safesharpsdisposal>

⚠ Do not dispose of your used sharps disposal container in your household trash unless your community guidelines permit this.

⚠ Do not recycle your used sharps disposal container.

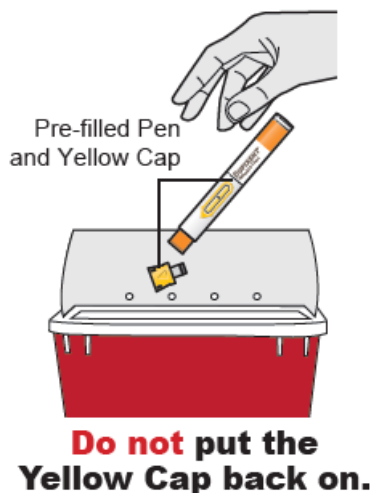

Keep your sharps disposal container out of the reach of children.

REGENERON sanofi

Manufactured by:
Regeneron Pharmaceuticals, Inc.
Tarrytown, NY 10591
U.S. License No. 1760

Marketed by:
sanofi-aventis U.S. LLC (Bridgewater, NJ 08807) and
Regeneron Pharmaceuticals, Inc. (Tarrytown, NY 10591)
DUPIXENT® is a registered trademark of Sanofi Biotechnology

© 2023 Regeneron Pharmaceuticals, Inc. / sanofi-aventis U.S. LLC. All rights reserved.

This Instructions for Use has been approved by the U.S. Food and Drug Administration.

Revised: July 2023

INSTRUCTIONS FOR USE
DUPIXENT® (DU-pix-ent)
(dupilumab)
injection, for subcutaneous use
Single-Dose Pre-filled Syringe with Needle Shield

Read this Instructions for Use before using the DUPIXENT Pre-filled Syringe. **Do not inject yourself or someone else until you have been shown how to inject DUPIXENT.** Your healthcare provider can show you or your caregiver how to prepare and inject a dose of DUPIXENT before you try to do it yourself the first time. Keep these instructions for future use. Call your healthcare provider if you have any questions.

This device is a **Single-Dose** Pre-filled Syringe (called “DUPIXENT Syringe” in these instructions). It contains 300 mg of DUPIXENT for injection under the skin (subcutaneous injection).

The parts of the DUPIXENT Syringe are shown below:

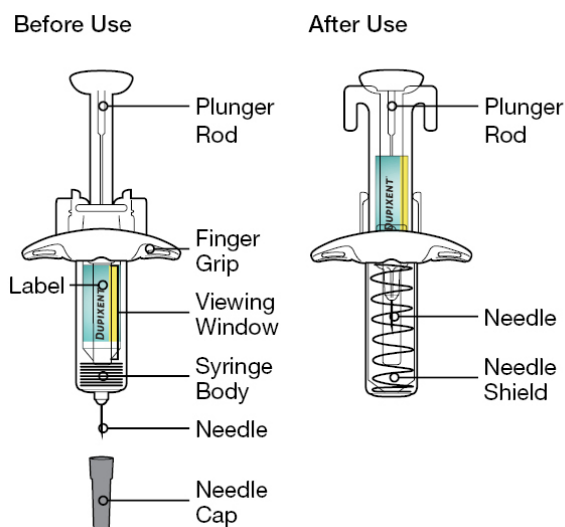

Important Information

- Read all of the instructions carefully before using the DUPIXENT Syringe.
- Ask your healthcare provider how often you will need to inject the medicine.
- **In children 12 years of age and older**, it is recommended that DUPIXENT be administered by or under supervision of an adult.
- **In children 6 months to less than 12 years of age**, DUPIXENT should be given by a caregiver.
- Rotate the injection site each time you inject.
- To reduce the risk of accidental needle sticks, each pre-filled syringe has a Needle Shield that is automatically activated to cover the needle after you have given your injection.
- **Do not** pull back on the Plunger Rod at any time.
- **Do not** remove the Needle Cap until just before you give the injection.
- Throw away (dispose of) the used DUPIXENT Single-Dose Pre-filled Syringe right away after use. See “Step 13: Dispose” below.

<ul style="list-style-type: none">• Do not use the DUPIXENT Syringe if it has been dropped on a hard surface or damaged.• Do not use the DUPIXENT Syringe if the Needle Cap is missing or not securely attached.• Do not touch the Plunger Rod until you are ready to inject.• Do not inject through clothes.• Do not get rid of any air bubble in the DUPIXENT Syringe.	<ul style="list-style-type: none">• Do not re-use a DUPIXENT Single-Dose Pre-filled Syringe.
<p>How should I store DUPIXENT?</p> <ul style="list-style-type: none">• Keep DUPIXENT Syringes and all medicines out of the reach of children.• Store DUPIXENT Syringes in the refrigerator between 36°F to 46°F (2°C to 8°C).• Store DUPIXENT Syringes in the original carton to protect them from light.• DUPIXENT Syringes can be stored at room temperature up to 77°F (25°C) up to 14 days. Throw away (dispose of) any DUPIXENT Syringes that have been left at room temperature for longer than 14 days.• Do not shake the DUPIXENT Syringe.• Do not heat the DUPIXENT Syringe.• Do not freeze the DUPIXENT Syringe.• Do not put the DUPIXENT Syringe into direct sunlight.	

Step 1: Remove

Remove the DUPIXENT Syringe from the carton by holding the middle of the Syringe Body.



Do not pull off the Needle Cap until you are ready to inject.



Do not use the DUPIXENT Syringe if it has been dropped on a hard surface or damaged.

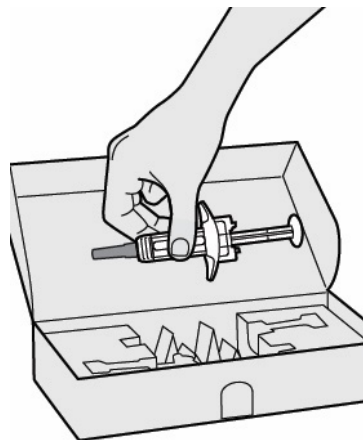

Step 2: Prepare

Ensure you have the following:

- the DUPIXENT Pre-filled Syringe
- 1 alcohol wipe*
- 1 cotton ball or gauze*
- a sharps disposal container* (See Step 13)

*Items not included in the carton

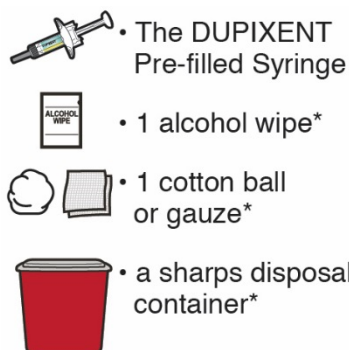

Step 3: Check

When you receive your DUPIXENT Syringes, always check to see that:

- you have the correct medicine and dose.
- the expiration date on the Single-Dose Pre-filled Syringe has not passed.



Do not use the DUPIXENT Syringe if the expiration date has passed.

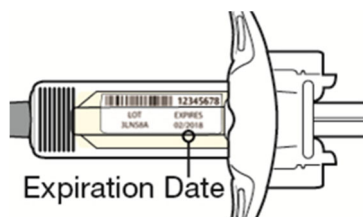

Step 4: Inspect

Look at the medicine through the Viewing Window on the DUPIXENT Syringe:

Check to see if the liquid is clear and colorless to pale yellow.

Note: You may see an air bubble, this is normal.



Do not use the DUPIXENT Syringe if the liquid is discolored or cloudy, or if it contains visible flakes or particles.

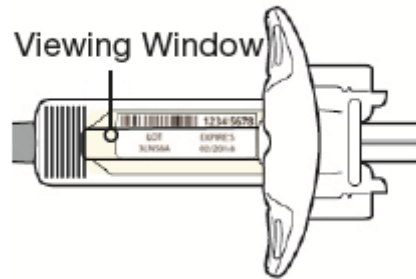

Step 5: Wait 45 minutes

Lay the DUPIXENT Syringe on a flat surface and let it naturally warm to room temperature for at least 45 minutes.



Do not heat the DUPIXENT Syringe.



Do not put the DUPIXENT Syringe into direct sunlight.



Do not keep DUPIXENT Syringes at room temperature for more than 14 days. Throw away (dispose of) any DUPIXENT Syringes that have been left at room temperature for longer than 14 days.

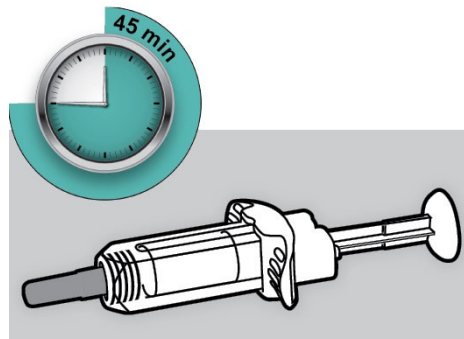



Step 6: Choose your injection site

- You can inject into your thigh or stomach, except for the 2 inches (5 cm) around your belly button (navel).
- If a caregiver injects your dose, they can also use the outer area of the upper arm.
- Choose a different site each time you inject DUPIXENT.

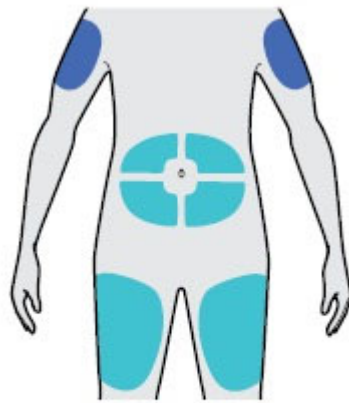

Do not inject into skin that is tender, damaged, bruised or scarred.



 = Self-injection or by caregiver
 = Injection by caregiver only

Step 7: Clean

Wash your hands.

Clean the injection site with an alcohol wipe.

Let your skin dry before injecting.

 **Do not touch the injection site again or blow on it before the injection.**



Step 8: Remove Needle Cap

Hold the DUPIXENT Syringe in the middle of the Syringe Body with the Needle pointing away from you and pull off the Needle Cap.

 **Do not put the Needle Cap back on.**

 **Do not touch the Needle.**

Inject your medicine right away after removing the Needle Cap.

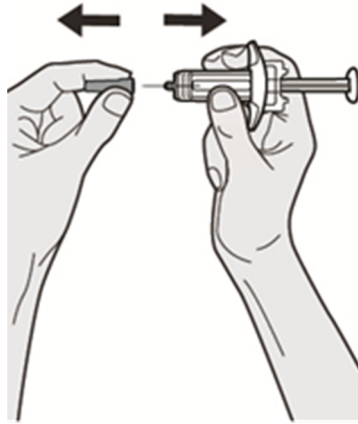

Step 9: Pinch

Pinch a fold of skin at the injection site (thigh or stomach, except 2 inches around your belly button, or outer area of the upper arm if injected by your caregiver). The figure below shows an example of pinching a fold of skin on your stomach.

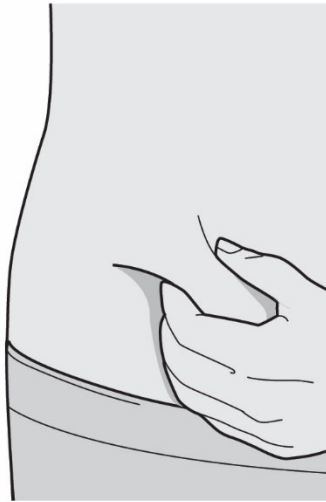

Step 10: Insert

Insert the Needle completely into the fold of the skin at about a 45° angle.

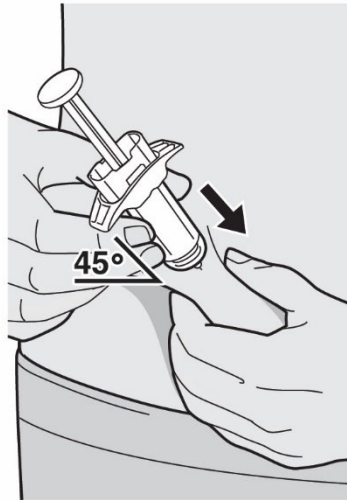

Step 11: Push

Relax the pinch.

Push the Plunger Rod down slowly and steadily as far as it will go until the DUPIXENT Syringe is empty.

Note: You will feel some resistance. This is normal.



Step 12: Release and Remove

Lift your thumb to release the Plunger Rod until the Needle is covered by the Needle Shield and then remove the Syringe from the injection site.

Lightly press a cotton ball or gauze on the injection site if you see any blood.



Do not put the Needle Cap back on.

 **Do not rub your skin after the injection.**

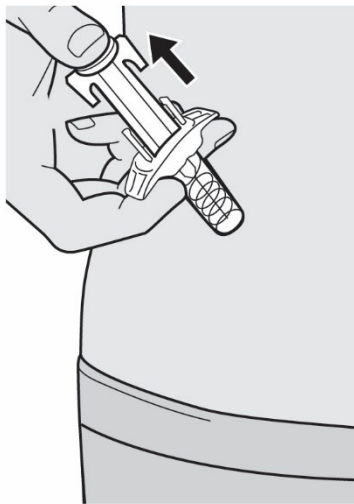

Step 13: Dispose

Put your used Needles, DUPIXENT Syringes, and Needle Caps in a FDA-cleared sharps disposal container right away after use.

 **Do not dispose of (throw away) Needles, DUPIXENT Syringes, and Needle Caps in your household trash.**

If you do not have a FDA-cleared sharps disposal container, you may use a household container that is:

- made of a heavy-duty plastic,
- can be closed with a tight-fitting, puncture-resistant lid, without sharps being able to come out,
- upright and stable during use,
- leak-resistant, and
- properly labeled to warn of hazardous waste inside the container

When your sharps disposal container is almost full, you will need to follow your community guidelines for the right way to dispose of your sharps disposal container. There may be state or local laws about how you should throw away used Needles and Syringes.

For more information about safe sharps disposal, and for specific information about sharps disposal in the state that you live in, go to the FDA's website at:
<http://www.fda.gov/safesharpsdisposal>

Do not dispose of your used sharps disposal container in your household trash unless your community guidelines permit this. **Do not** recycle your used sharps disposal container.

 **Do not put the Needle Cap back on.**

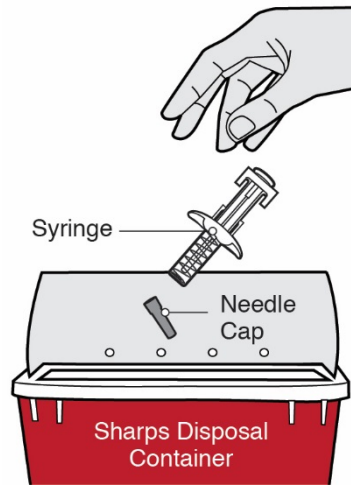

REGENERON sanofi

Manufactured by: Regeneron Pharmaceuticals, Inc. Tarrytown, NY 10591
U.S. License No. 1760

Marketed by: sanofi-aventis U.S. LLC (Bridgewater, NJ 08807) and Regeneron Pharmaceuticals, Inc. (Tarrytown, NY 10591)
DUPIXENT® is a registered trademark of Sanofi Biotechnology

© 2023 Regeneron Pharmaceuticals, Inc. / sanofi-aventis U.S. LLC. All rights reserved.

This Instructions for Use has been approved by the U.S. Food and Drug Administration.
Revised: July 2023

Instructions for Use
DUPIXENT® (DU-pix-ent)
(dupilumab)
injection, for subcutaneous use
Single-Dose Pre-filled Pen (300 mg/2 mL)

This Instructions for Use contains information on how to inject DUPIXENT.

Read this Instructions for Use before using the DUPIXENT Pre-filled Pen. **Do not inject yourself or someone else until you have been shown how to inject DUPIXENT.** Your healthcare provider can show you or your caregiver how to prepare and inject a dose of DUPIXENT before you try to do it yourself for the first time. Keep this Instructions for Use. Call your healthcare provider if you have any questions.

This DUPIXENT Pre-filled Pen is only for use in adults and children aged 2 years and older.

This DUPIXENT Pre-filled Pen is a single-dose device. It contains 300 mg of DUPIXENT for injection under the skin (subcutaneous injection).

The parts of the DUPIXENT Pre-filled Pen are shown below:

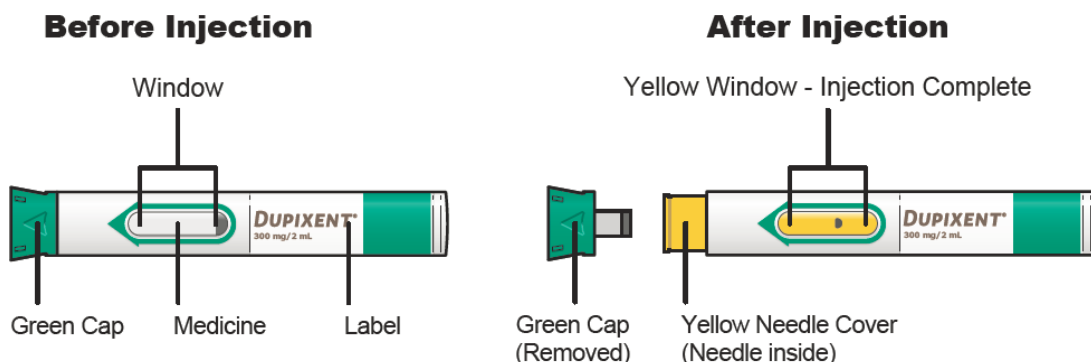

Important Information

- Read all of the instructions carefully before using the DUPIXENT Pre-filled Pen.
- Ask your healthcare provider how often you will need to inject the medicine.
- **In children 12 years of age and older**, it is recommended that DUPIXENT be administered by or under supervision of an adult.
- **In children 2 years to less than 12 years of age**, DUPIXENT should be given by a caregiver.
- Choose a different injection site for each injection.
- **Do not** press or touch the Yellow Needle Cover with your fingers.
- **Do not** inject through clothes.
- **Do not** remove the Green Cap until just before you give the injection.
- **Do not** try to put the Green Cap back on the DUPIXENT Pre-filled Pen.
- Throw away (dispose of) the used DUPIXENT Pre-filled Pen right away after use.
- **Do not** re-use a DUPIXENT Pre-filled Pen.

Storing DUPIXENT

- Store unused DUPIXENT Pre-filled Pens in the refrigerator between 36°F to 46°F (2°C to 8°C).
- Store DUPIXENT Pre-filled Pens in the original carton to protect from light.
- If necessary, you may keep DUPIXENT Pre-filled Pens at room temperature up to 77°F (25°C) for up to **14 days**.
- **Do not** store DUPIXENT Pre-filled Pens at room temperature more than 77°F (25°C).
- After removing a DUPIXENT Pre-filled Pen from the refrigerator, it must be used within 14 days or thrown away (disposed of).
- **Do not** shake the DUPIXENT Pre-filled Pen at any time.
- **Do not** heat the DUPIXENT Pre-filled Pen.
- **Do not** freeze the DUPIXENT Pre-filled Pen.
- **Do not** put the DUPIXENT Pre-filled Pen into direct sunlight.
- **Keep DUPIXENT Pre-filled Pens and all medicines out of the reach of children.**

A. Get ready to inject

A1. Gather supplies

Find a clean, flat work surface. Make sure you have the following supplies:

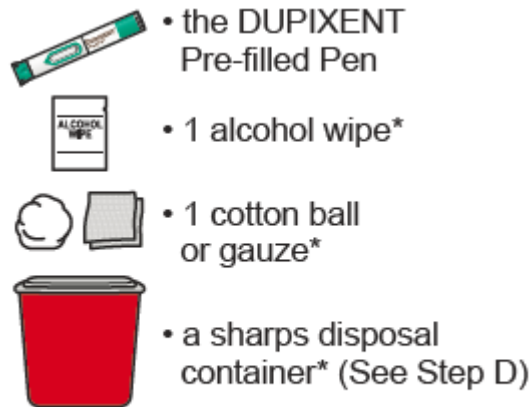

* Items not included in the carton.

A2. Check the Pen

- **Do not** use the DUPIXENT Pre-filled Pen if it has been damaged.
- **Do not** use the DUPIXENT Pre-filled Pen if the Green Cap is missing or not securely attached.
- **Do not** use the DUPIXENT Pre-filled Pen if the Window is yellow before use.

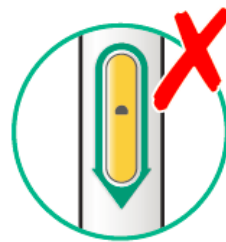







A3. Look at the Label

- Check to be sure that you have the correct Medicine and dose.

Check the Medicine and Dose



<ul style="list-style-type: none">• Check the expiration date.•  Do not use the DUPIXENT Pre-filled Pen if the expiration date has passed.	 <p>Check Expiration Date</p>
A4. Check the Medicine	
<ul style="list-style-type: none">• Look at the Medicine through the Window: it should be clear and colorless to pale yellow.• Note: You may see an air bubble, this is normal.•  Do not use the DUPIXENT Pre-filled Pen if the liquid is discolored or cloudy, or if it contains visible flakes or particles.	 <p>Check Window</p>
A5. Wait 45 minutes	
<ul style="list-style-type: none">• Lay the DUPIXENT Pre-filled Pen on a flat surface and let it warm up at room temperature less than 77°F (25°C) for at least 45 minutes.•  Do not heat the DUPIXENT Pre-filled Pen in a microwave, hot water or direct sunlight.	 <p>45 minutes</p>

B. Choose and prepare your injection site

B1. Wash your hands well with soap and water



B2. Choose an injection site

- **Thigh**
- **Stomach** except for the 2 inches (5 cm) around your belly button (navel).
- A caregiver can also inject in the outer area of the **upper arm**.
- Choose a different site for each injection.
- ⚠️ **Do not** inject into skin that is tender, damaged, has bruises or scars, or into areas with visible veins.
- ⚠️ **Do not** inject through clothes.

Self-injection Sites

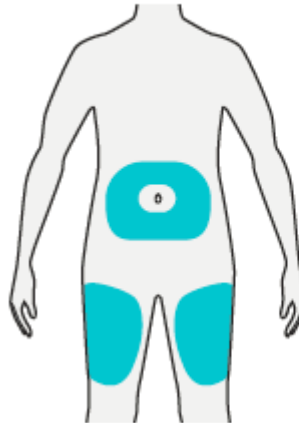

Caregiver Injection Sites

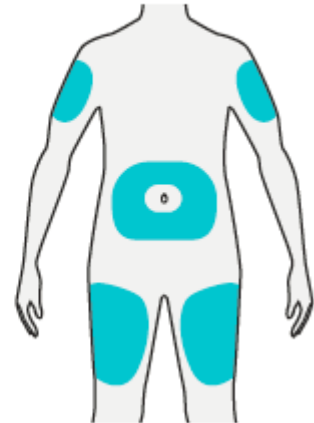

B3. Prepare the injection site

- Clean the injection site with an alcohol wipe.
- Let the skin dry before injecting.
-  **Do not** touch the injection site again or blow on it before the injection.

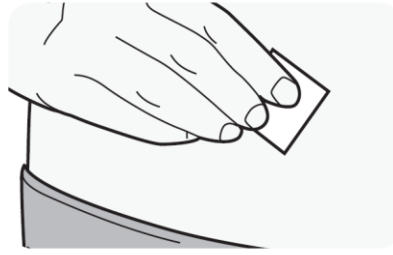

C. Give the injection

C1. Remove Green Cap

- Remove the Green Cap by pulling it straight off, as shown. **Do not** twist the Green Cap off.
- **Do not** remove the Green Cap until you are ready to inject.
- **Do not** press or touch the Yellow Needle Cover with your fingers. The Needle is inside.
-  **Do not** put the Green Cap back on the DUPIXENT Pre-filled Pen after you have removed it.

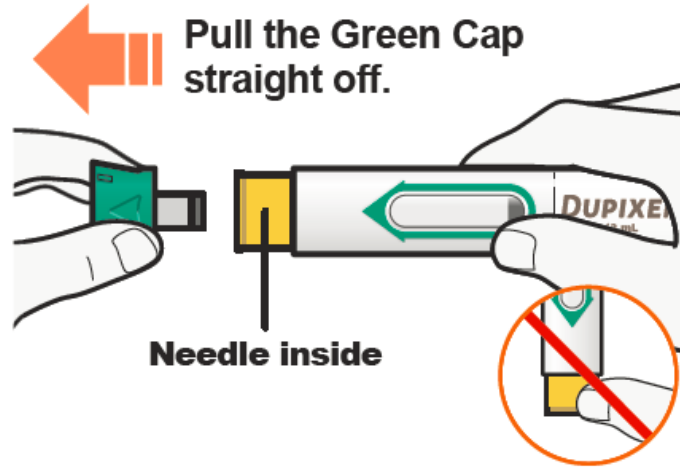

C2. Pinch Skin and Place

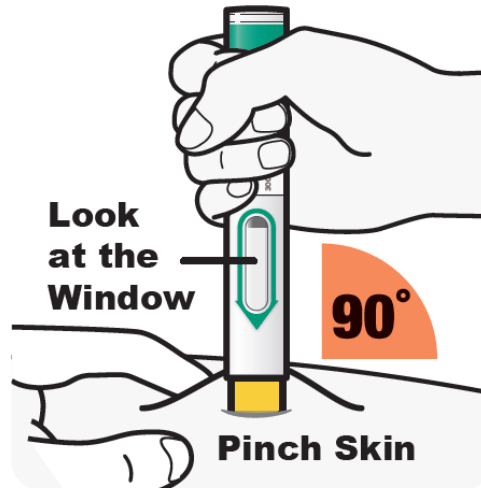

Pinch the skin before and during the injection.

- Hold the DUPIXENT Pre-filled Pen as shown so that you can see the Window. Place the Yellow Needle Cover on the skin.
- Place the Yellow Needle Cover on the skin at approximately a 90-degree angle.
- Pinching is not needed for adults and children aged 12 years and older.

C3. Press down → Watch Window turn fully yellow → Then count to 5



Press and hold the DUPIXENT Pre-filled Pen firmly against the skin **until you cannot see the Yellow Needle Cover.**

- There will be a “click” when the injection starts, **and**
- The Window will start to turn yellow.
- **Keep pressing** the DUPIXENT Pre-filled Pen against the skin.



Keep pressing the DUPIXENT Pre-filled Pen against the skin and watch the window:

- The Window will turn completely yellow, **and**
- You will hear a **2nd “click”**.
- **Keep pressing** the DUPIXENT Pre-filled Pen against the skin.

Keep pressing the DUPIXENT Pre-filled Pen against the skin and **count to 5 to make sure you get your full dose.**

Pinching of the skin is not needed for adults and children aged 12 years and older.

C4. Remove

- After you have completed the injection pull straight up to remove DUPIXENT Pre-filled Pen from the skin. The Yellow Needle Cover will cover the needle.
- If you see any blood at the site, lightly dab a cotton ball or gauze pad.
-  **Do not** rub the skin after the injection.
- If the Window does not turn completely Yellow, or if it looks like medicine is still coming out of the pen, you may not have received a full dose. Dispose of (throw away) the pen and contact your healthcare provider right away.
-  **Do not** give a second dose without speaking to your healthcare provider.

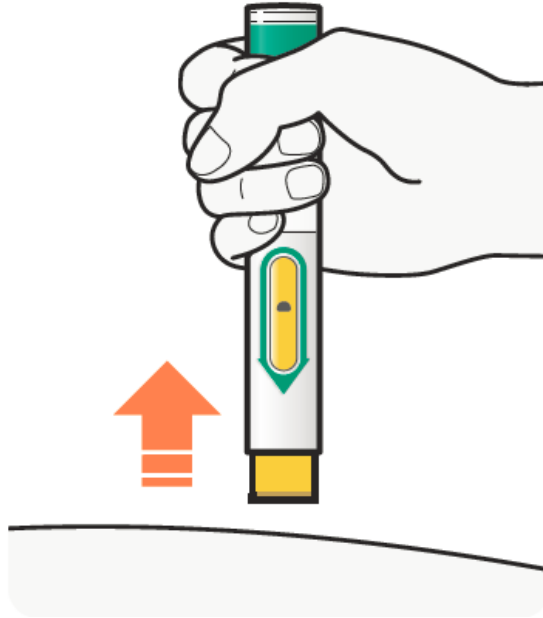

D. Dispose of used DUPIXENT Pre-filled Pen

How to Dispose of (throw away) DUPIXENT Pre-filled Pen:

Put the used DUPIXENT Pre-filled Pens and Green Caps in a FDA-cleared sharps disposal container right away after use.

⚠ Do not dispose of (throw away) DUPIXENT Pre-filled Pens and Green Caps in your household trash.

If you do not have a FDA-cleared sharps disposal container, you may use a household container that is:

- made of a heavy-duty plastic,
- can be closed with a tightfitting, puncture-resistant lid, without sharps being able to come out,
- upright and stable during use,
- leak-resistant, and
- properly labeled to warn of hazardous waste inside the container.

When your sharps disposal container is almost full, you will need to follow your community guidelines for the right way to dispose of your sharps disposal container. There may be state or local laws about how you should throw away used DUPIXENT Pre-filled Pens.

For more information about safe sharps disposal, and for specific information about sharps disposal in the state that you live in, go to the FDA's website at: <http://www.fda.gov/safesharpsdisposal>

⚠ Do not dispose of your used sharps disposal container in your household trash unless your community guidelines permit this.

⚠ Do not recycle your used sharps disposal container.

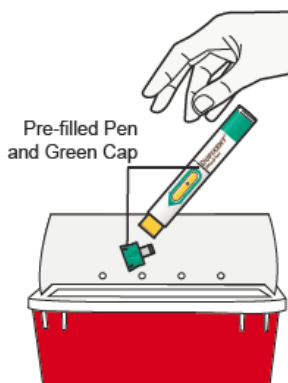

**Do not put
the Green Cap
back on.**

Keep your sharps disposal container out of the reach of children.

REGENERON sanofi

Manufactured by:
Regeneron Pharmaceuticals, Inc.
Tarrytown, NY 10591

U.S. License No. 1760

Marketed by:

sanofi-aventis U.S. LLC (Bridgewater, NJ 08807) and
Regeneron Pharmaceuticals, Inc. (Tarrytown, NY 10591)

DUPIXENT® is a registered trademark of Sanofi Biotechnology

© 2023 Regeneron Pharmaceuticals, Inc. / sanofi-aventis U.S. LLC. All rights reserved.

This Instructions for Use has been approved by the U.S. Food and Drug Administration.

Revised: July 2023