

HIGHLIGHTS OF PRESCRIBING INFORMATION

These highlights do not include all the information needed to use ELIQUIS safely and effectively. See full prescribing information for ELIQUIS.

ELIQUIS® (apixaban) tablets, for oral use

ELIQUIS® (apixaban) tablets for oral suspension

ELIQUIS® SPRINKLE (apixaban) for oral suspension

Initial U.S. Approval: 2012

**WARNING: (A) PREMATURE DISCONTINUATION OF ELIQUIS INCREASES THE RISK OF THROMBOTIC EVENTS
(B) SPINAL/EPIDURAL HEMATOMA**

See full prescribing information for complete boxed warning.

(A) PREMATURE DISCONTINUATION OF ELIQUIS INCREASES THE RISK OF THROMBOTIC EVENTS: Premature discontinuation of any oral anticoagulant, including ELIQUIS, increases the risk of thrombotic events. To reduce this risk, consider coverage with another anticoagulant if ELIQUIS is discontinued for a reason other than pathological bleeding or completion of a course of therapy. (2.5, 5.1, 14.1)

(B) SPINAL/EPIDURAL HEMATOMA: Epidural or spinal hematomas may occur in patients treated with ELIQUIS who are receiving neuraxial anesthesia or undergoing spinal puncture. These hematomas may result in long-term or permanent paralysis. Consider these risks when scheduling patients for spinal procedures. (5.3)

RECENT MAJOR CHANGES

Indications and Usage (1.6) 04/2025
Dosage and Administration (2.2, 2.6, 2.7) 04/2025
Warnings and Precautions (5.2, 5.3) 04/2025

INDICATIONS AND USAGE

ELIQUIS is a factor Xa inhibitor indicated:

- to reduce the risk of stroke and systemic embolism in adult patients with nonvalvular atrial fibrillation. (1.1)
- for the prophylaxis of deep vein thrombosis (DVT), which may lead to pulmonary embolism (PE), in adult patients who have undergone hip or knee replacement surgery. (1.2)
- for the treatment of DVT and PE, and for the reduction in the risk of recurrent DVT and PE in adult patients following initial therapy. (1.3, 1.4, 1.5)
- Treatment of venous thromboembolism (VTE) and reduction in the risk of recurrent VTE in pediatric patients from birth and older after at least 5 days of initial anticoagulant treatment. (1.6)

DOSAGE AND ADMINISTRATION

- Reduction of risk of stroke and systemic embolism in nonvalvular atrial fibrillation:
 - The recommended dose is 5 mg orally twice daily. (2.1)
 - In patients with at least 2 of the following characteristics: age greater than or equal to 80 years, body weight less than or equal to 60 kg, or serum creatinine greater than or equal to 1.5 mg/dL, the recommended dose is 2.5 mg orally twice daily. (2.1)

- Prophylaxis of DVT following hip or knee replacement surgery:
 - The recommended dose is 2.5 mg orally twice daily. (2.1)
- Treatment of DVT and PE:
 - The recommended dose is 10 mg taken orally twice daily for 7 days, followed by 5 mg taken orally twice daily. (2.1)
- Reduction in the risk of recurrent DVT and PE following initial therapy:
 - The recommended dose is 2.5 mg taken orally twice daily. (2.1)
- Treatment of VTE and reduction in the risk of recurrent VTE in pediatric patients from birth and older after at least 5 days of initial anticoagulant treatment:
 - See dosing recommendations in the Full Prescribing Information (2.2)

DOSAGE FORMS AND STRENGTHS

- Tablets: 2.5 mg and 5 mg (3)
- Tablet For Oral Suspension: 0.5 mg (3)
- For Oral Suspension: 0.15 mg in a yellow opaque capsule (3)

CONTRAINDICATIONS

- Active pathological bleeding (4)
- Severe hypersensitivity to ELIQUIS (4)

WARNINGS AND PRECAUTIONS

- ELIQUIS can cause serious, potentially fatal, bleeding. Promptly evaluate signs and symptoms of blood loss. An agent to reverse the anti-factor Xa activity of apixaban is available. (5.2)
- Prosthetic heart valves: ELIQUIS use not recommended. (5.4)
- Increased Risk of Thrombosis in Patients with Triple Positive Antiphospholipid Syndrome: ELIQUIS use not recommended. (5.6)

ADVERSE REACTIONS

- Most common adverse reactions (>1%) in adult patients are related to bleeding. (6.1)
- The most common adverse reactions (≥10%) in pediatric patients were headache, vomiting, and excessive menstrual bleeding. (6.1)

To report SUSPECTED ADVERSE REACTIONS, contact Bristol-Myers Squibb at 1-800-721-5072 or FDA at 1-800-FDA-1088 or www.fda.gov/medwatch.

DRUG INTERACTIONS

- Combined P-gp and strong CYP3A4 inhibitors increase blood levels of apixaban. Reduce ELIQUIS dose or avoid coadministration. (2.6, 7.1, 12.3)
- Simultaneous use of combined P-gp and strong CYP3A4 inducers reduces blood levels of apixaban: Avoid concomitant use. (7.2, 12.3)

USE IN SPECIFIC POPULATIONS

- *Pregnancy:* Not recommended. (8.1)
- *Lactation:* Advise not to breastfeed. (8.2)
- *Severe Hepatic Impairment:* Not recommended. (8.7, 12.2)

See 17 for PATIENT COUNSELING INFORMATION and Medication Guide.

Revised: 04/2025

FULL PRESCRIBING INFORMATION: CONTENTS*

**WARNING: (A) PREMATURE DISCONTINUATION OF ELIQUIS INCREASES THE RISK OF THROMBOTIC EVENTS
(B) SPINAL/EPIDURAL HEMATOMA**

1 INDICATIONS AND USAGE

- 1.1 Reduction of Risk of Stroke and Systemic Embolism in Nonvalvular Atrial Fibrillation
- 1.2 Prophylaxis of Deep Vein Thrombosis Following Hip or Knee Replacement Surgery
- 1.3 Treatment of Deep Vein Thrombosis
- 1.4 Treatment of Pulmonary Embolism
- 1.5 Reduction in the Risk of Recurrence of DVT and PE
- 1.6 Treatment of VTE and Reduction in the Risk of Recurrent VTE in Pediatric Patients

2 DOSAGE AND ADMINISTRATION

- 2.1 Recommended Dose in Adult Patients
- 2.2 Recommended Dose in Pediatric Patients
- 2.3 Missed Dose
- 2.4 Temporary Interruption for Surgery and Other Interventions
- 2.5 Converting from or to ELIQUIS
- 2.6 Combined P-gp and Strong CYP3A4 Inhibitors
- 2.7 Administration Options

3 DOSAGE FORMS AND STRENGTHS

4 CONTRAINDICATIONS

5 WARNINGS AND PRECAUTIONS

- 5.1 Increased Risk of Thrombotic Events after Premature Discontinuation
- 5.2 Bleeding
- 5.3 Spinal/Epidural Anesthesia or Puncture
- 5.4 Patients with Prosthetic Heart Valves
- 5.5 Acute PE in Hemodynamically Unstable Patients or Patients who Require Thrombolysis or Pulmonary Embolectomy
- 5.6 Increased Risk of Thrombosis in Patients with Triple Positive Antiphospholipid Syndrome

6 ADVERSE REACTIONS

- 6.1 Clinical Trials Experience

7 DRUG INTERACTIONS

- 7.1 Combined P-gp and Strong CYP3A4 Inhibitors
- 7.2 Combined P-gp and Strong CYP3A4 Inducers
- 7.3 Anticoagulants and Antiplatelet Agents

8 USE IN SPECIFIC POPULATIONS

- 8.1 Pregnancy
- 8.2 Lactation

- 8.3 Females and Males of Reproductive Potential
- 8.4 Pediatric Use
- 8.5 Geriatric Use
- 8.6 Renal Impairment
- 8.7 Hepatic Impairment

10 OVERDOSAGE

11 DESCRIPTION

12 CLINICAL PHARMACOLOGY

- 12.1 Mechanism of Action
- 12.2 Pharmacodynamics
- 12.3 Pharmacokinetics

13 NONCLINICAL TOXICOLOGY

- 13.1 Carcinogenesis, Mutagenesis, Impairment of Fertility

14 CLINICAL STUDIES

- 14.1 Reduction of Risk of Stroke and Systemic Embolism in Nonvalvular Atrial Fibrillation
- 14.2 Prophylaxis of Deep Vein Thrombosis Following Hip or Knee Replacement Surgery
- 14.3 Treatment of DVT and PE and Reduction in the Risk of Recurrence of DVT and PE
- 14.4 Treatment of VTE and Prevention of Recurrent VTE in Pediatric Patients from birth and older

16 HOW SUPPLIED/STORAGE AND HANDLING

17 PATIENT COUNSELING INFORMATION

* Sections or subsections omitted from the full prescribing information are not listed.

FULL PRESCRIBING INFORMATION

WARNING: (A) PREMATURE DISCONTINUATION OF ELIQUIS INCREASES THE RISK OF THROMBOTIC EVENTS (B) SPINAL/EPIDURAL HEMATOMA

(A) PREMATURE DISCONTINUATION OF ELIQUIS INCREASES THE RISK OF THROMBOTIC EVENTS

Premature discontinuation of any oral anticoagulant, including ELIQUIS, increases the risk of thrombotic events. If anticoagulation with ELIQUIS is discontinued for a reason other than pathological bleeding or completion of a course of therapy, consider coverage with another anticoagulant [see *Dosage and Administration (2.5)*, *Warnings and Precautions (5.1)*, and *Clinical Studies (14.1)*].

(B) SPINAL/EPIDURAL HEMATOMA

Epidural or spinal hematomas may occur in patients treated with ELIQUIS who are receiving neuraxial anesthesia or undergoing spinal puncture. These hematomas may result in long-term or permanent paralysis. Consider these risks when scheduling patients for spinal procedures. Factors that can increase the risk of developing epidural or spinal hematomas in these patients include:

- use of indwelling epidural catheters
- concomitant use of other drugs that affect hemostasis, such as nonsteroidal anti-inflammatory drugs (NSAIDs), platelet inhibitors, other anticoagulants
- a history of traumatic or repeated epidural or spinal punctures
- a history of spinal deformity or spinal surgery
- optimal timing between the administration of ELIQUIS and neuraxial procedures is not known

[see *Warnings and Precautions (5.3)*]

Monitor patients frequently for signs and symptoms of neurological impairment. If neurological compromise is noted, urgent treatment is necessary [see *Warnings and Precautions (5.3)*].

Consider the benefits and risks before neuraxial intervention in patients anticoagulated or to be anticoagulated [see *Warnings and Precautions (5.3)*].

1 INDICATIONS AND USAGE

1.1 Reduction of Risk of Stroke and Systemic Embolism in Nonvalvular Atrial Fibrillation

ELIQUIS is indicated to reduce the risk of stroke and systemic embolism in adult patients with nonvalvular atrial fibrillation.

1.2 Prophylaxis of Deep Vein Thrombosis Following Hip or Knee Replacement Surgery

ELIQUIS is indicated for the prophylaxis of deep vein thrombosis (DVT), which may lead to pulmonary embolism (PE), in adult patients who have undergone hip or knee replacement surgery.

1.3 Treatment of Deep Vein Thrombosis

ELIQUIS is indicated for the treatment of adults with deep vein thrombosis (DVT).

1.4 Treatment of Pulmonary Embolism

ELIQUIS is indicated for the treatment of adults with pulmonary embolism (PE).

1.5 Reduction in the Risk of Recurrence of Deep Vein Thrombosis and Pulmonary Embolism

ELIQUIS is indicated to reduce the risk of recurrent deep vein thrombosis (DVT) and pulmonary embolism (PE) in adult patients following initial therapy.

1.6 Treatment of Venous Thromboembolism and Reduction in the Risk of Recurrent Venous Thromboembolism in Pediatric Patients

ELIQUIS is indicated for the treatment of venous thromboembolism (VTE) and reduction in the risk of recurrent VTE in pediatric patients from birth and older after at least 5 days of initial anticoagulant treatment.

2 DOSAGE AND ADMINISTRATION

2.1 Recommended Dose in Adult Patients

Reduction of Risk of Stroke and Systemic Embolism in Patients with Nonvalvular Atrial Fibrillation

The recommended dose of ELIQUIS for most patients is 5 mg taken orally twice daily.

The recommended dose of ELIQUIS is 2.5 mg twice daily in patients with at least two of the following characteristics:

- age greater than or equal to 80 years
- body weight less than or equal to 60 kg
- serum creatinine greater than or equal to 1.5 mg/dL

Prophylaxis of Deep Vein Thrombosis Following Hip or Knee Replacement Surgery

The recommended dose of ELIQUIS is 2.5 mg taken orally twice daily. The initial dose should be taken 12 to 24 hours after surgery.

- In patients undergoing hip replacement surgery, the recommended duration of treatment is 35 days.
- In patients undergoing knee replacement surgery, the recommended duration of treatment is 12 days.

Treatment of DVT and PE

The recommended dose of ELIQUIS is 10 mg taken orally twice daily for the first 7 days of therapy. After 7 days, the recommended dose is 5 mg taken orally twice daily.

Reduction in the Risk of Recurrence of DVT and PE

The recommended dose of ELIQUIS is 2.5 mg taken orally twice daily after at least 6 months of treatment for DVT or PE [see *Clinical Studies (14.3)*].

2.2 Recommended Dose in Pediatric Patients

Treatment of Venous Thromboembolism (VTE) and Reduction in the Risk of Recurrent VTE in Pediatric Patients

The recommended dose of ELIQUIS is based on the patient's weight, see Table 1. Adjust the dose according to weight-tier as treatment progresses. Initiate ELIQUIS treatment for pediatric patients from birth to less than 18 years of age following at least 5 days of initial anticoagulation therapy. Individualize duration of overall therapy after careful assessment of the treatment benefit and the risk for bleeding.

Table 1: Dose Recommendation in Pediatric Patients from Birth to less than 18 Years of Age for the Treatment of VTE and Reduction in the Risk of Recurrent VTE

		Days 1-7	Days 8 and beyond
Presentation	Body weight (kg)	Dosing schedule	Dosing schedule
Powder in Capsule 0.15 mg For pediatric use	2.6 to less than 4	0.3 mg twice daily	0.15 mg twice daily
Tablet 0.5 mg For pediatric use	4 to less than 6	1 mg twice daily	0.5 mg twice daily
	6 to less than 9	2 mg twice daily	1 mg twice daily
	9 to less than 12	3 mg twice daily	1.5 mg twice daily
	12 to less than 18	4 mg twice daily	2 mg twice daily
	18 to less than 25	6 mg twice daily	3 mg twice daily
	25 to less than 35	8 mg twice daily	4 mg twice daily
Tablets 2.5 mg and 5 mg	greater than or equal to 35	10 mg twice daily	5 mg twice daily

ELIQUIS is not recommended for use in pediatric patients less than 2.6 kg because ELIQUIS was not studied in these patients.

2.3 Missed Dose

If a dose of ELIQUIS is not taken at the scheduled time, the dose should be taken as soon as possible on the same day and twice-daily administration should be resumed. The dose should not be doubled to make up for a missed dose.

2.4 Temporary Interruption for Surgery and Other Interventions

ELIQUIS should be discontinued at least 48 hours prior to elective surgery or invasive procedures with a moderate or high risk of unacceptable or clinically significant bleeding [*see Warnings and Precautions (5.2)*]. ELIQUIS should be discontinued at least 24 hours prior to elective surgery or invasive procedures with a low risk of bleeding or where the bleeding would be non-critical in location and easily controlled. Bridging anticoagulation during the 24 to 48 hours after stopping ELIQUIS and prior to the intervention is not generally required. ELIQUIS should be restarted after the surgical or other procedures as soon as adequate hemostasis has been established.

2.5 Converting from or to ELIQUIS

Switching from warfarin to ELIQUIS: Warfarin should be discontinued and ELIQUIS started when the international normalized ratio (INR) is below 2.0.

Switching from ELIQUIS to warfarin: ELIQUIS affects INR, so that initial INR measurements during the transition to warfarin may not be useful for determining the appropriate dose of warfarin. One approach is to discontinue ELIQUIS and begin both a parenteral anticoagulant and warfarin at the time the next dose of ELIQUIS would have been taken, discontinuing the parenteral anticoagulant when INR reaches an acceptable range.

Switching from ELIQUIS to anticoagulants other than warfarin (oral or parenteral): Discontinue ELIQUIS and begin taking the new anticoagulant other than warfarin at the usual time of the next dose of ELIQUIS.

Switching from anticoagulants other than warfarin (oral or parenteral) to ELIQUIS: Discontinue the anticoagulant other than warfarin and begin taking ELIQUIS at the usual time of the next dose of the anticoagulant other than warfarin.

2.6 Combined P-gp and Strong CYP3A4 Inhibitors

For adult patients receiving ELIQUIS doses of 5 mg or 10 mg twice daily, reduce the dose by 50% when ELIQUIS is coadministered with drugs that are combined P-glycoprotein (P-gp) and strong cytochrome P450 3A4 (CYP3A4) inhibitors (e.g., ketoconazole, itraconazole, ritonavir) [*see Clinical Pharmacology (12.3)*].

In patients already taking 2.5 mg twice daily, avoid coadministration of ELIQUIS with combined P-gp and strong CYP3A4 inhibitors [*see Drug Interactions (7.1)*].

2.7 Administration Options

Adult and pediatric patients weighing greater than or equal to 35 kg.

For patients who are unable to swallow whole tablets, 5 mg and 2.5 mg ELIQUIS tablets may be crushed and suspended in water, 5% dextrose in water (D5W), or apple juice, or mixed with

applesauce and promptly administered orally [see *Clinical Pharmacology (12.3)*]. Alternatively, ELIQUIS tablets may be crushed and suspended in 60 mL of water or D5W and promptly delivered through a 12 French nasogastric tube [see *Clinical Pharmacology (12.3)*].

Following administration of the dose, the nasogastric tube should be flushed with an additional 20 mL of water or D5W.

Crushed ELIQUIS tablets are stable in water, D5W, apple juice, and applesauce for up to 4 hours.

Pediatric patients weighing less than 35 kg.

Capsules

The 0.15 mg ELIQUIS SPRINKLE capsule must be opened, and the entire contents sprinkled in water or infant formula, mixed, and administered as described in the Instructions for Use (IFU). The liquid mixtures should be administered within 2 hours. Do not swallow capsule.

Tablets for oral suspension

The 0.5 mg ELIQUIS tablet in a packet for oral suspension should be mixed with water, infant formula, apple juice, or apple sauce as described in the IFU. The liquid mixtures with water, infant formula or apple juice should be administered within 2 hours and the mixture in apple sauce should be administered immediately. Each packet is for single use only. For pediatric patients who have difficulty swallowing, the liquid mixture can be delivered through a 5 French, 6.5 French or 12 French nasogastric tube or gastrostomy tube. See IFU.

3 DOSAGE FORMS AND STRENGTHS

- 0.5 mg, pink, round, film-coated tablets for oral suspension packaged in packets. 1-count (0.5 mg), 3-count (1.5 mg), and 4-count (2 mg).
- 2.5 mg, yellow, round, biconvex, film-coated tablets with “893” debossed on one side and “2½” on the other side.
- 5 mg, pink, oval-shaped, biconvex, film-coated tablets with “894” debossed on one side and “5” on the other side.
- 0.15 mg, white to pale yellow powder for oral suspension, in a yellow opaque capsule marked “898”

4 CONTRAINDICATIONS

ELIQUIS is contraindicated in patients with the following conditions:

- Active pathological bleeding [see *Warnings and Precautions (5.2) and Adverse Reactions (6.1)*]
- Severe hypersensitivity reaction to ELIQUIS (e.g., anaphylactic reactions) [see *Adverse Reactions (6.1)*]

5 WARNINGS AND PRECAUTIONS

5.1 Increased Risk of Thrombotic Events after Premature Discontinuation

Premature discontinuation of any oral anticoagulant, including ELIQUIS, in the absence of adequate alternative anticoagulation increases the risk of thrombotic events. An increased rate of stroke was observed during the transition from ELIQUIS to warfarin in clinical trials in atrial fibrillation patients. If ELIQUIS is discontinued for a reason other than pathological bleeding or completion of a course of therapy, consider coverage with another anticoagulant [*see Dosage and Administration (2.5) and Clinical Studies (14.1)*].

5.2 Bleeding

ELIQUIS increases the risk of bleeding and can cause serious, potentially fatal, bleeding [*see Dosage and Administration (2.1) and Adverse Reactions (6.1)*].

Concomitant use of drugs affecting hemostasis increases the risk of bleeding. These include aspirin and other antiplatelet agents, other anticoagulants, heparin, thrombolytic agents, selective serotonin reuptake inhibitors, serotonin norepinephrine reuptake inhibitors, and nonsteroidal anti-inflammatory drugs (NSAIDs) [*see Drug Interactions (7.3)*].

Advise patients of signs and symptoms of blood loss and to report them immediately or go to an emergency room. Discontinue ELIQUIS in patients with active pathological hemorrhage.

Reversal of Anticoagulant Effect

A specific reversal agent (andexanet alfa) antagonizing the pharmacodynamic effect of apixaban is available for adults. However, its safety and efficacy have not been established in pediatric patients (refer to the USPI of andexanet alfa). The pharmacodynamic effect of ELIQUIS can be expected to persist for at least 24 hours after the last dose, i.e., for about two drug half-lives. Prothrombin complex concentrate (PCC), activated prothrombin complex concentrate or recombinant factor VIIa may be considered, but have not been evaluated in clinical studies [*see Clinical Pharmacology (12.2)*]. When PCCs are used, monitoring for the anticoagulation effect of apixaban using a clotting test (PT, INR, or aPTT) or anti-factor Xa (FXa) activity is not useful and is not recommended. Activated oral charcoal reduces absorption of apixaban, thereby lowering apixaban plasma concentration [*see Overdosage (10)*].

Hemodialysis does not appear to have a substantial impact on apixaban exposure [*see Clinical Pharmacology (12.3)*]. Protamine sulfate and vitamin K are not expected to affect the anticoagulant activity of apixaban. There is no experience with antifibrinolytic agents (tranexamic acid, aminocaproic acid) in individuals receiving apixaban. There is no experience with systemic hemostatics (desmopressin) in individuals receiving ELIQUIS, and they are not expected to be effective as a reversal agent.

5.3 Spinal/Epidural Anesthesia or Puncture

When neuraxial anesthesia (spinal/epidural anesthesia) or spinal/epidural puncture is employed, patients treated with antithrombotic agents for prevention of thromboembolic complications are at

risk of developing an epidural or spinal hematoma which can result in long-term or permanent paralysis.

The risk of these events may be increased by the postoperative use of indwelling epidural catheters or the concomitant use of medicinal products affecting hemostasis. Indwelling epidural or intrathecal catheters should not be removed earlier than 24 hours after the last administration of ELIQUIS. The next dose of ELIQUIS should not be administered earlier than 5 hours after the removal of the catheter. The risk may also be increased by traumatic or repeated epidural or spinal puncture. If traumatic puncture occurs, delay the administration of ELIQUIS for 48 hours.

Monitor patients frequently for signs and symptoms of neurological impairment (e.g., numbness or weakness of the legs, or bowel or bladder dysfunction). If neurological compromise is noted, urgent diagnosis and treatment is necessary. Prior to neuraxial intervention the physician should consider the potential benefit versus the risk in anticoagulated patients or in patients to be anticoagulated for thromboprophylaxis.

No data are available on the timing of the placement or removal of neuraxial catheters in pediatric patients while on ELIQUIS. In such cases, discontinue ELIQUIS and consider a short acting parenteral anticoagulant.

5.4 Patients with Prosthetic Heart Valves

The safety and efficacy of ELIQUIS have not been studied in patients with prosthetic heart valves. Therefore, use of ELIQUIS is not recommended in these patients.

5.5 Acute PE in Hemodynamically Unstable Patients or Patients who Require Thrombolysis or Pulmonary Embolectomy

Initiation of ELIQUIS is not recommended as an alternative to unfractionated heparin for the initial treatment of patients with PE who present with hemodynamic instability or who may receive thrombolysis or pulmonary embolectomy.

5.6 Increased Risk of Thrombosis in Patients with Triple Positive Antiphospholipid Syndrome

Direct-acting oral anticoagulants (DOACs), including ELIQUIS, are not recommended for use in patients with triple-positive antiphospholipid syndrome (APS). For patients with APS (especially those who are triple positive [positive for lupus anticoagulant, anticardiolipin, and anti-beta 2-glycoprotein I antibodies]), treatment with DOACs has been associated with increased rates of recurrent thrombotic events compared with vitamin K antagonist therapy.

6 ADVERSE REACTIONS

The following clinically significant adverse reactions are discussed in greater detail in other sections of the prescribing information.

- Increased Risk of Thrombotic Events After Premature Discontinuation [*see Warnings and Precautions (5.1)*]
- Bleeding [*see Warnings and Precautions (5.2)*]
- Spinal/Epidural Anesthesia or Puncture [*see Warnings and Precautions (5.3)*]

6.1 Clinical Trials Experience

Adult Patients

Because clinical trials are conducted under widely varying conditions, adverse reaction rates observed in the clinical trials of a drug cannot be directly compared to rates in the clinical trials of another drug and may not reflect the rates observed in practice.

Reduction of Risk of Stroke and Systemic Embolism in Patients with Nonvalvular Atrial Fibrillation

The safety of ELIQUIS was evaluated in the ARISTOTLE and AVERROES studies [see *Clinical Studies (14)*], including 11,284 patients exposed to ELIQUIS 5 mg twice daily and 602 patients exposed to ELIQUIS 2.5 mg twice daily. The duration of ELIQUIS exposure was ≥ 12 months for 9375 patients and ≥ 24 months for 3369 patients in the two studies. In ARISTOTLE, the mean duration of exposure was 89 weeks ($>15,000$ patient-years). In AVERROES, the mean duration of exposure was approximately 59 weeks (>3000 patient-years).

The most common reason for treatment discontinuation in both studies was for bleeding-related adverse reactions; in ARISTOTLE this occurred in 1.7% and 2.5% of patients treated with ELIQUIS and warfarin, respectively, and in AVERROES, in 1.5% and 1.3% on ELIQUIS and aspirin, respectively.

Bleeding in Patients with Nonvalvular Atrial Fibrillation in ARISTOTLE and AVERROES

Tables 2 and 3 show the number of patients experiencing major bleeding during the treatment period and the bleeding rate (percentage of subjects with at least one bleeding event per 100 patient-years) in ARISTOTLE and AVERROES.

Table 2: Bleeding Events in Patients with Nonvalvular Atrial Fibrillation in ARISTOTLE*

	ELIQUIS N=9088 n (per 100 pt-year)	Warfarin N=9052 n (per 100 pt-year)	Hazard Ratio (95% CI)	P-value
Major [†]	327 (2.13)	462 (3.09)	0.69 (0.60, 0.80)	<0.0001
Intracranial (ICH) [‡]	52 (0.33)	125 (0.82)	0.41 (0.30, 0.57)	-
Hemorrhagic stroke [§]	38 (0.24)	74 (0.49)	0.51 (0.34, 0.75)	-
Other ICH	15 (0.10)	51 (0.34)	0.29 (0.16, 0.51)	-
Gastrointestinal (GI) [¶]	128 (0.83)	141 (0.93)	0.89 (0.70, 1.14)	-
Fatal**	10 (0.06)	37 (0.24)	0.27 (0.13, 0.53)	-
Intracranial	4 (0.03)	30 (0.20)	0.13 (0.05, 0.37)	-
Non-intracranial	6 (0.04)	7 (0.05)	0.84 (0.28, 2.15)	-

* Bleeding events within each subcategory were counted once per subject, but subjects may have contributed events to multiple endpoints. Bleeding events were counted during treatment or within 2 days of stopping study treatment (on-treatment period).

† Defined as clinically overt bleeding accompanied by one or more of the following: a decrease in hemoglobin of ≥ 2 g/dL, a transfusion of 2 or more units of packed red blood cells, bleeding at a critical site: intracranial, intraspinal, intraocular, pericardial, intra-articular, intramuscular with compartment syndrome, retroperitoneal or with fatal outcome.

‡ Intracranial bleed includes intracerebral, intraventricular, subdural, and subarachnoid bleeding. Any type of hemorrhagic stroke was adjudicated and counted as an intracranial major bleed.

§ On-treatment analysis based on the safety population, compared to ITT analysis presented in Section 14.

¶ GI bleed includes upper GI, lower GI, and rectal bleeding.

**Fatal bleeding is an adjudicated death with the primary cause of death as intracranial bleeding or non-intracranial bleeding during the on-treatment period.

In ARISTOTLE, the results for major bleeding were generally consistent across most major subgroups including age, weight, CHADS₂ score (a scale from 0 to 6 used to estimate risk of stroke, with higher scores predicting greater risk), prior warfarin use, geographic region, and aspirin use at randomization (Figure 1). Subjects treated with ELIQUIS with diabetes bled more (3% per year) than did subjects without diabetes (1.9% per year).

Figure 1:

Major Bleeding Hazard Ratios by Baseline Characteristics – ARISTOTLE Study

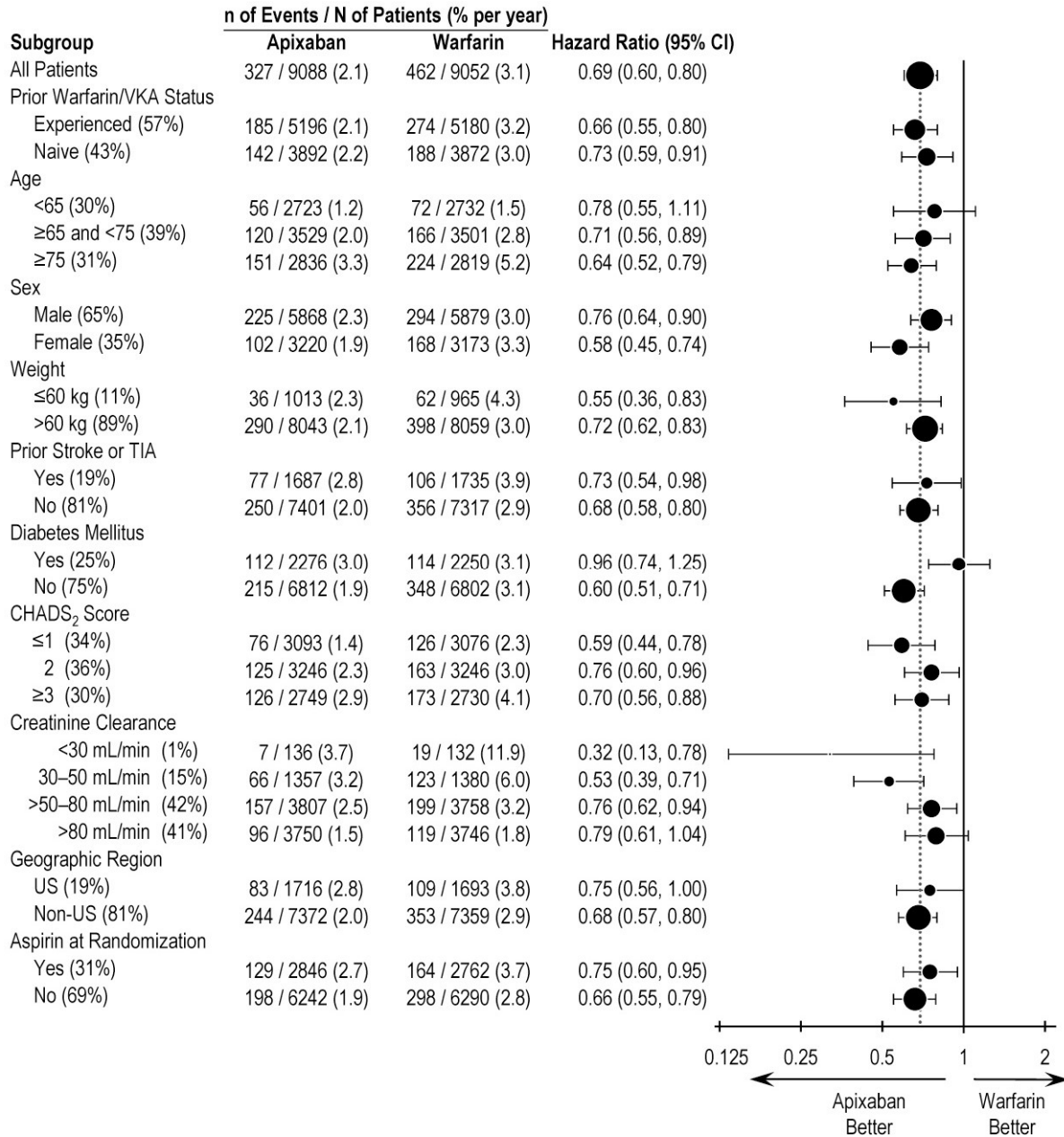

Note: The figure above presents effects in various subgroups, all of which are baseline characteristics and all of which were prespecified, if not the groupings. The 95% confidence limits that are shown do not take into account how many comparisons were made, nor do they reflect the effect of a particular factor after adjustment for all other factors. Apparent homogeneity or heterogeneity among groups should not be over-interpreted.

Table 3: Bleeding Events in Patients with Nonvalvular Atrial Fibrillation in AVERROES

	ELIQUIS N=2798 n (%/year)	Aspirin N=2780 n (%/year)	Hazard Ratio (95% CI)	P-value
Major	45 (1.41)	29 (0.92)	1.54 (0.96, 2.45)	0.07
Fatal	5 (0.16)	5 (0.16)	0.99 (0.23, 4.29)	-
Intracranial	11 (0.34)	11 (0.35)	0.99 (0.39, 2.51)	-

Events associated with each endpoint were counted once per subject, but subjects may have contributed events to multiple endpoints.

Other Adverse Reactions

Hypersensitivity reactions (including drug hypersensitivity, such as skin rash, and anaphylactic reactions, such as allergic edema) and syncope were reported in <1% of patients receiving ELIQUIS.

Prophylaxis of Deep Vein Thrombosis Following Hip or Knee Replacement Surgery

The safety of ELIQUIS has been evaluated in 1 Phase II and 3 Phase III studies including 5924 patients exposed to ELIQUIS 2.5 mg twice daily undergoing major orthopedic surgery of the lower limbs (elective hip replacement or elective knee replacement) treated for up to 38 days.

In total, 11% of the patients treated with ELIQUIS 2.5 mg twice daily experienced adverse reactions.

Bleeding results during the treatment period in the Phase III studies are shown in Table 4. Bleeding was assessed in each study beginning with the first dose of double-blind study drug.

Table 4: Bleeding During the Treatment Period in Patients Undergoing Elective Hip or Knee Replacement Surgery

Bleeding Endpoint*	ADVANCE-3 Hip Replacement Surgery		ADVANCE-2 Knee Replacement Surgery		ADVANCE-1 Knee Replacement Surgery	
	ELIQUIS 2.5 mg po bid 35±3 days	Enoxaparin 40 mg sc qd 35±3 days	ELIQUIS 2.5 mg po bid 12±2 days	Enoxaparin 40 mg sc qd 12±2 days	ELIQUIS 2.5 mg po bid 12±2 days	Enoxaparin 30 mg sc q12h 12±2 days
	First dose 12 to 24 hours post surgery	First dose 9 to 15 hours prior to surgery	First dose 12 to 24 hours post surgery	First dose 9 to 15 hours prior to surgery	First dose 12 to 24 hours post surgery	First dose 12 to 24 hours post surgery
All treated	N=2673	N=2659	N=1501	N=1508	N=1596	N=1588
Major (including surgical site)	22 (0.82%) [†]	18 (0.68%)	9 (0.60%) [‡]	14 (0.93%)	11 (0.69%)	22 (1.39%)
Fatal	0	0	0	0	0	1 (0.06%)

Table 4: Bleeding During the Treatment Period in Patients Undergoing Elective Hip or Knee Replacement Surgery

Bleeding Endpoint*	ADVANCE-3 Hip Replacement Surgery		ADVANCE-2 Knee Replacement Surgery		ADVANCE-1 Knee Replacement Surgery	
Hgb decrease ≥ 2 g/dL	13 (0.49%)	10 (0.38%)	8 (0.53%)	9 (0.60%)	10 (0.63%)	16 (1.01%)
Transfusion of ≥ 2 units RBC	16 (0.60%)	14 (0.53%)	5 (0.33%)	9 (0.60%)	9 (0.56%)	18 (1.13%)
Bleed at critical site [§]	1 (0.04%)	1 (0.04%)	1 (0.07%)	2 (0.13%)	1 (0.06%)	4 (0.25%)
Major + CRNM [¶]	129 (4.83%)	134 (5.04%)	53 (3.53%)	72 (4.77%)	46 (2.88%)	68 (4.28%)
All	313 (11.71%)	334 (12.56%)	104 (6.93%)	126 (8.36%)	85 (5.33%)	108 (6.80%)

* All bleeding criteria included surgical site bleeding.

† Includes 13 subjects with major bleeding events that occurred before the first dose of ELIQUIS (administered 12 to 24 hours post surgery).

‡ Includes 5 subjects with major bleeding events that occurred before the first dose of ELIQUIS (administered 12 to 24 hours post surgery).

§ Intracranial, intraspinal, intraocular, pericardial, an operated joint requiring re-operation or intervention, intramuscular with compartment syndrome, or retroperitoneal. Bleeding into an operated joint requiring re-operation or intervention was present in all patients with this category of bleeding. Events and event rates include one enoxaparin-treated patient in ADVANCE-1 who also had intracranial hemorrhage.

¶ CRNM = clinically relevant nonmajor.

Adverse reactions occurring in $\geq 1\%$ of patients undergoing hip or knee replacement surgery in the 1 Phase II study and the 3 Phase III studies are listed in Table 5.

Table 5: Adverse Reactions Occurring in $\geq 1\%$ of Patients in Either Group Undergoing Hip or Knee Replacement Surgery

	ELIQUIS, n (%) 2.5 mg po bid N=5924	Enoxaparin, n (%) 40 mg sc qd or 30 mg sc q12h N=5904
Nausea	153 (2.6)	159 (2.7)
Anemia (including postoperative and hemorrhagic anemia, and respective laboratory parameters)	153 (2.6)	178 (3.0)
Contusion	83 (1.4)	115 (1.9)
Hemorrhage (including hematoma, and vaginal and urethral hemorrhage)	67 (1.1)	81 (1.4)
Postprocedural hemorrhage (including postprocedural hematoma, wound hemorrhage, vessel puncture-site hematoma, and catheter-site hemorrhage)	54 (0.9)	60 (1.0)

Table 5: Adverse Reactions Occurring in $\geq 1\%$ of Patients in Either Group Undergoing Hip or Knee Replacement Surgery

	ELIQUIS, n (%) 2.5 mg po bid N=5924	Enoxaparin, n (%) 40 mg sc qd or 30 mg sc q12h N=5904
Transaminases increased (including alanine aminotransferase increased and alanine aminotransferase abnormal)	50 (0.8)	71 (1.2)
Aspartate aminotransferase increased	47 (0.8)	69 (1.2)
Gamma-glutamyltransferase increased	38 (0.6)	65 (1.1)

Less common adverse reactions in ELIQUIS-treated patients undergoing hip or knee replacement surgery occurring at a frequency of $\geq 0.1\%$ to $< 1\%$:

Blood and lymphatic system disorders: thrombocytopenia (including platelet count decreases)

Vascular disorders: hypotension (including procedural hypotension)

Respiratory, thoracic, and mediastinal disorders: epistaxis

Gastrointestinal disorders: gastrointestinal hemorrhage (including hematemesis and melena), hemochezia

Hepatobiliary disorders: liver function test abnormal, blood alkaline phosphatase increased, blood bilirubin increased

Renal and urinary disorders: hematuria (including respective laboratory parameters)

Injury, poisoning, and procedural complications: wound secretion, incision-site hemorrhage (including incision-site hematoma), operative hemorrhage

Less common adverse reactions in ELIQUIS-treated patients undergoing hip or knee replacement surgery occurring at a frequency of $< 0.1\%$:

Gingival bleeding, hemoptysis, hypersensitivity, muscle hemorrhage, ocular hemorrhage (including conjunctival hemorrhage), rectal hemorrhage

Treatment of DVT and PE and Reduction in the Risk of Recurrence of DVT or PE

The safety of ELIQUIS has been evaluated in the AMPLIFY and AMPLIFY-EXT studies, including 2676 patients exposed to ELIQUIS 10 mg twice daily, 3359 patients exposed to ELIQUIS 5 mg twice daily, and 840 patients exposed to ELIQUIS 2.5 mg twice daily.

Common adverse reactions ($\geq 1\%$) were gingival bleeding, epistaxis, contusion, hematuria, rectal hemorrhage, hematoma, menorrhagia, and hemoptysis.

AMPLIFY Study

The mean duration of exposure to ELIQUIS was 154 days and to enoxaparin/warfarin was 152 days in the AMPLIFY study. Adverse reactions related to bleeding occurred in 417 (15.6%) ELIQUIS-treated patients compared to 661 (24.6%) enoxaparin/warfarin-treated patients. The

discontinuation rate due to bleeding events was 0.7% in the ELIQUIS-treated patients compared to 1.7% in enoxaparin/warfarin-treated patients in the AMPLIFY study.

In the AMPLIFY study, ELIQUIS was statistically superior to enoxaparin/warfarin in the primary safety endpoint of major bleeding (relative risk 0.31, 95% CI [0.17, 0.55], P-value <0.0001).

Bleeding results from the AMPLIFY study are summarized in Table 6.

Table 6: Bleeding Results in the AMPLIFY Study

	ELIQUIS N=2676 n (%)	Enoxaparin/Warfarin N=2689 n (%)	Relative Risk (95% CI)
Major	15 (0.6)	49 (1.8)	0.31 (0.17, 0.55) p<0.0001
CRNM*	103 (3.9)	215 (8.0)	
Major + CRNM	115 (4.3)	261 (9.7)	
Minor	313 (11.7)	505 (18.8)	
All	402 (15.0)	676 (25.1)	

* CRNM = clinically relevant nonmajor bleeding.

Events associated with each endpoint were counted once per subject, but subjects may have contributed events to multiple endpoints.

Adverse reactions occurring in $\geq 1\%$ of patients in the AMPLIFY study are listed in Table 7.

Table 7: Adverse Reactions Occurring in $\geq 1\%$ of Patients Treated for DVT and PE in the AMPLIFY Study

	ELIQUIS N=2676 n (%)	Enoxaparin/Warfarin N=2689 n (%)
Epistaxis	77 (2.9)	146 (5.4)
Contusion	49 (1.8)	97 (3.6)
Hematuria	46 (1.7)	102 (3.8)
Menorrhagia	38 (1.4)	30 (1.1)
Hematoma	35 (1.3)	76 (2.8)
Hemoptysis	32 (1.2)	31 (1.2)
Rectal hemorrhage	26 (1.0)	39 (1.5)
Gingival bleeding	26 (1.0)	50 (1.9)

AMPLIFY-EXT Study

The mean duration of exposure to ELIQUIS was approximately 330 days and to placebo was 312 days in the AMPLIFY-EXT study. Adverse reactions related to bleeding occurred in 219 (13.3%) ELIQUIS-treated patients compared to 72 (8.7%) placebo-treated patients. The discontinuation

rate due to bleeding events was approximately 1% in the ELIQUIS-treated patients compared to 0.4% in those patients in the placebo group in the AMPLIFY-EXT study.

Bleeding results from the AMPLIFY-EXT study are summarized in Table 8.

Table 8: Bleeding Results in the AMPLIFY-EXT Study

	ELIQUIS 2.5 mg bid N=840 n (%)	ELIQUIS 5 mg bid N=811 n (%)	Placebo N=826 n (%)
Major	2 (0.2)	1 (0.1)	4 (0.5)
CRNM*	25 (3.0)	34 (4.2)	19 (2.3)
Major + CRNM	27 (3.2)	35 (4.3)	22 (2.7)
Minor	75 (8.9)	98 (12.1)	58 (7.0)
All	94 (11.2)	121 (14.9)	74 (9.0)

* CRNM = clinically relevant nonmajor bleeding.

Events associated with each endpoint were counted once per subject, but subjects may have contributed events to multiple endpoints.

Adverse reactions occurring in $\geq 1\%$ of patients in the AMPLIFY-EXT study are listed in Table 9.

Table 9: Adverse Reactions Occurring in $\geq 1\%$ of Patients Undergoing Extended Treatment for DVT and PE in the AMPLIFY-EXT Study

	ELIQUIS 2.5 mg bid N=840 n (%)	ELIQUIS 5 mg bid N=811 n (%)	Placebo N=826 n (%)
Epistaxis	13 (1.5)	29 (3.6)	9 (1.1)
Hematuria	12 (1.4)	17 (2.1)	9 (1.1)
Hematoma	13 (1.5)	16 (2.0)	10 (1.2)
Contusion	18 (2.1)	18 (2.2)	18 (2.2)
Gingival bleeding	12 (1.4)	9 (1.1)	3 (0.4)

Other Adverse Reactions

Less common adverse reactions in ELIQUIS-treated patients in the AMPLIFY or AMPLIFY-EXT studies occurring at a frequency of $\geq 0.1\%$ to $< 1\%$:

Blood and lymphatic system disorders: hemorrhagic anemia

Gastrointestinal disorders: hematochezia, hemorrhoidal hemorrhage, gastrointestinal hemorrhage, hematemesis, melena, anal hemorrhage

Injury, poisoning, and procedural complications: wound hemorrhage, postprocedural hemorrhage, traumatic hematoma, periorbital hematoma

Musculoskeletal and connective tissue disorders: muscle hemorrhage

Reproductive system and breast disorders: vaginal hemorrhage, metrorrhagia, menometrorrhagia, genital hemorrhage

Vascular disorders: hemorrhage

Skin and subcutaneous tissue disorders: ecchymosis, skin hemorrhage, petechiae

Eye disorders: conjunctival hemorrhage, retinal hemorrhage, eye hemorrhage

Investigations: blood urine present, occult blood positive, occult blood, red blood cells urine positive

General disorders and administration-site conditions: injection-site hematoma, vessel puncture-site hematoma

Pediatric Patients

Treatment of Venous Thromboembolism (VTE) and Reduction in the Risk of Recurrent VTE in Pediatric Patients

The safety assessment of ELIQUIS is based on data from CV185325, a phase 3 study in 225 patients from birth and older. Patients were randomized 2:1 to receive body weight-adjusted doses of an age-appropriate formulation of ELIQUIS or standard of care. The standard of care treatments included unfractionated heparin (UFH), low molecular weight heparin (LMWH), or vitamin K antagonist (VKA).

Overall, the safety profile of ELIQUIS in pediatric patients from birth and older was generally similar to that in adults and consistent across different pediatric age groups. In pediatric patients, excessive menstrual bleeding occurred in 17 (11%) patients in the ELIQUIS group and 3 (4%) patients in the standard of care group. Epistaxis occurred in 24 (16%) patients in the ELIQUIS group and 14 (19%) patients in the standard of care group.

Bleeding results from Study CV185325 in pediatric patients with VTE are summarized in Table 10.

Table 10: Bleeding Results in Study CV185325 – Safety Analysis Set – Main Phase

	ELIQUIS N=152	Standard of care ** N=73
Major Bleeding		
Number (%) Subjects with Event 95% Confidence Interval (1)	0	0
CRNM*		
Number (%) Subjects with Event	2 (1.3)	1 (1.4)
95% Confidence Interval (1)	(0.2, 4.7)	(0.0, 7.4)

Minor Bleeding		
Number (%) Subjects with Event	54 (35.5)	21 (28.8)
95% Confidence Interval (1)	(27.9, 43.7)	(18.8, 40.6)
All		
Number (%) Subjects with Event	55 (36.2)	21 (28.8)
95% Confidence Interval (1)	(28.6, 44.4)	(18.8, 40.6)

* CRNM = clinically relevant nonmajor bleeding.

(1) 95% Confidence Interval calculated using the Clopper-Pearson exact method

Events associated with each endpoint were counted once per subject, but subjects may have contributed events to multiple endpoints.

** UFH/LMWH for patients less than 2 years of age and UFH/LMWH/VKA for those equal to or greater than 2 years of age.

Non-bleeding adverse reactions occurring in $\geq 10\%$ of patients in study CV185325 are listed in Table 11.

Table 11: Other Adverse Reactions Occurring in $\geq 10\%$ of Patients in Study CV185325

Number of Subjects Evaluable for Adverse Reaction	ELIQUIS N=152 n (%)	Standard of Care N=73 n (%)
Headache	25 (16.4)	11 (15.1)
Vomiting	21 (13.8)	5 (6.8)

7 DRUG INTERACTIONS

7.1 Combined P-gp and Strong CYP3A4 Inhibitors

For patients receiving ELIQUIS 5 mg or 10 mg twice daily, the dose of ELIQUIS should be decreased by 50% when coadministered with drugs that are combined P-gp and strong CYP3A4 inhibitors (e.g., ketoconazole, itraconazole, ritonavir) [see *Dosage and Administration (2.6) and Clinical Pharmacology (12.3)*].

For patients receiving ELIQUIS at a dose of 2.5 mg twice daily, avoid coadministration with combined P-gp and strong CYP3A4 inhibitors [see *Dosage and Administration (2.6) and Clinical Pharmacology (12.3)*].

Concomitant administration of combined P-gp and strong CYP3A4 inhibitors has not been studied in pediatric patients.

Apixaban is a substrate of both CYP3A4 and P-gp. Concomitant use with drugs that are combined P-gp and strong CYP3A4 inhibitors increases exposure to apixaban [see *Clinical Pharmacology (12.3)*] which increases the risk for bleeding.

Clarithromycin

Although clarithromycin is a combined P-gp and strong CYP3A4 inhibitor, pharmacokinetic data suggest that no dose adjustment is necessary with concomitant administration with ELIQUIS [see *Clinical Pharmacology (12.3)*].

7.2 Combined P-gp and Strong CYP3A4 Inducers

Avoid concomitant use of ELIQUIS with combined P-gp and strong CYP3A4 inducers (e.g., rifampin, carbamazepine, phenytoin, St. John's wort) because such drugs will decrease exposure to apixaban [see *Clinical Pharmacology (12.3)*].

Apixaban is a substrate of both CYP3A4 and P-gp. Concomitant use with drugs that are combined P-gp and strong CYP3A4 inducers decreases exposure to apixaban [see *Clinical Pharmacology (12.3)*] which increases the risk for stroke and other thromboembolic events.

7.3 Anticoagulants and Antiplatelet Agents

Coadministration of antiplatelet agents, fibrinolytics, heparin, aspirin, and chronic NSAID use increases the risk of bleeding.

APPRAISE-2, a placebo-controlled clinical trial of ELIQUIS in high-risk, post-acute coronary syndrome patients treated with aspirin or the combination of aspirin and clopidogrel, was terminated early due to a higher rate of bleeding with ELIQUIS compared to placebo. The rate of ISTH major bleeding was 2.8% per year with ELIQUIS versus 0.6% per year with placebo in patients receiving single antiplatelet therapy and was 5.9% per year with ELIQUIS versus 2.5% per year with placebo in those receiving dual antiplatelet therapy.

In ARISTOTLE, concomitant use of aspirin increased the bleeding risk on ELIQUIS from 1.8% per year to 3.4% per year and concomitant use of aspirin and warfarin increased the bleeding risk from 2.7% per year to 4.6% per year. In this clinical trial, there was limited (2.3%) use of dual antiplatelet therapy with ELIQUIS.

8 USE IN SPECIFIC POPULATIONS

8.1 Pregnancy

Risk Summary

The limited available data on ELIQUIS use in pregnant women are insufficient to inform drug-associated risks of major birth defects, miscarriage, or adverse developmental outcomes. Treatment may increase the risk of bleeding during pregnancy and delivery. In animal reproduction studies, no adverse developmental effects were seen when apixaban was administered to rats (orally), rabbits (intravenously) and mice (orally) during organogenesis at unbound apixaban exposure levels up to 4, 1 and 19 times, respectively, the human exposure based on area under

plasma-concentration time curve (AUC) at the Maximum Recommended Human Dose (MRHD) of 5 mg twice daily.

The estimated background risk of major birth defects and miscarriage for the indicated populations is unknown. All pregnancies have a background risk of birth defect, loss, or other adverse outcomes. In the U.S. general population, the estimated background risk of major birth defects and miscarriage in clinically recognized pregnancies is 2% to 4% and 15% to 20%, respectively.

Clinical Considerations

Disease-associated maternal and/or embryo/fetal risk

Pregnancy confers an increased risk of thromboembolism that is higher for women with underlying thromboembolic disease and certain high-risk pregnancy conditions. Published data describe that women with a previous history of venous thrombosis are at high risk for recurrence during pregnancy.

Fetal/Neonatal adverse reactions

Use of anticoagulants, including ELIQUIS, may increase the risk of bleeding in the fetus and neonate.

Labor or delivery

All patients receiving anticoagulants, including pregnant women, are at risk for bleeding. ELIQUIS use during labor or delivery in women who are receiving neuraxial anesthesia may result in epidural or spinal hematomas. Consider use of a shorter acting anticoagulant as delivery approaches [see *Warnings and Precautions (5.3)*].

Data

Animal Data

No developmental toxicities were observed when apixaban was administered during organogenesis to rats (orally), rabbits (intravenously) and mice (orally) at unbound apixaban exposure levels 4, 1, and 19 times, respectively, the human exposures at the MRHD. There was no evidence of fetal bleeding, although conceptus exposure was confirmed in rats and rabbits. Oral administration of apixaban to rat dams from gestation day 6 through lactation day 21 at maternal unbound apixaban exposures ranging from 1.4 to 5 times the human exposures at the MRHD was not associated with reduced maternal mortality or reduced conceptus/neonatal viability, although increased incidences of peri-vaginal bleeding were observed in dams at all doses. There was no evidence of neonatal bleeding.

8.2 Lactation

Risk Summary

There are no data on the presence of apixaban or its metabolites in human milk, the effects on the breastfed child, or the effects on milk production. Apixaban and/or its metabolites were present in the milk of rats (*see Data*). Because human exposure through milk is unknown, breastfeeding is not recommended during treatment with ELIQUIS.

Data

Animal Data

Maximal plasma concentrations were observed after 30 minutes following a single oral administration of a 5 mg dose to lactating rats. Maximal milk concentrations were observed 6 hours after dosing. The milk to plasma AUC (0-24) ratio is 30:1 indicating that apixaban can accumulate in milk. The concentrations of apixaban in animal milk does not necessarily predict the concentration of drug in human milk.

8.3 Females and Males of Reproductive Potential

Females of reproductive potential requiring anticoagulation should discuss pregnancy planning with their physician.

The risk of clinically significant uterine bleeding, potentially requiring gynecological surgical interventions, identified with oral anticoagulants including ELIQUIS should be assessed in females of reproductive potential and those with abnormal uterine bleeding.

8.4 Pediatric Use

The safety and effectiveness of ELIQUIS for the treatment of VTE and the reduction in the risk of recurrent VTE have been established in pediatric patients aged birth and older. Use of ELIQUIS for this indication is supported by evidence from adequate and well-controlled studies in adults with additional pharmacokinetic, safety, and efficacy data in pediatric patients. These studies included a randomized, active controlled, open label, multi-center study of ELIQUIS [see *Adverse Reactions (6.1) and Clinical Studies (14.4)*].

8.5 Geriatric Use

Of the total subjects in the ARISTOTLE and AVERROES clinical studies, >69% were 65 years of age and older, and >31% were 75 years of age and older. In the ADVANCE-1, ADVANCE-2, and ADVANCE-3 clinical studies, 50% of subjects were 65 years of age and older, while 16% were 75 years of age and older. In the AMPLIFY and AMPLIFY-EXT clinical studies, >32% of subjects were 65 years of age and older and >13% were 75 years of age and older. No clinically significant differences in safety or effectiveness were observed when comparing subjects in different age groups.

8.6 Renal Impairment

Reduction of Risk of Stroke and Systemic Embolism in Patients with Nonvalvular Atrial Fibrillation

The recommended dose is 2.5 mg twice daily in patients with at least two of the following characteristics [see *Dosage and Administration (2.1)*]:

- age greater than or equal to 80 years
- body weight less than or equal to 60 kg
- serum creatinine greater than or equal to 1.5 mg/dL

Patients with End-Stage Renal Disease on Dialysis

Clinical efficacy and safety studies with ELIQUIS did not enroll patients with end-stage renal disease (ESRD) on dialysis. In patients with ESRD maintained on intermittent hemodialysis, administration of ELIQUIS at the usually recommended dose [see *Dosage and Administration (2.1)*] will result in concentrations of apixaban and pharmacodynamic activity similar to those observed in the ARISTOTLE study [see *Clinical Pharmacology (12.3)*]. It is not known whether these concentrations will lead to similar stroke reduction and bleeding risk in patients with ESRD on dialysis as was seen in ARISTOTLE.

Prophylaxis of Deep Vein Thrombosis Following Hip or Knee Replacement Surgery, and Treatment of DVT and PE and Reduction in the Risk of Recurrence of DVT and PE

No dose adjustment is recommended for patients with renal impairment, including those with ESRD on dialysis [see *Dosage and Administration (2.1)*]. Clinical efficacy and safety studies with ELIQUIS did not enroll patients with ESRD on dialysis or patients with a CrCl <15 mL/min; therefore, dosing recommendations are based on pharmacokinetic and pharmacodynamic (anti-FXa activity) data in subjects with ESRD maintained on dialysis [see *Clinical Pharmacology (12.3)*].

Treatment of Venous Thromboembolism (VTE) and Reduction in the Risk of Recurrent VTE in Pediatric Patients

In pediatric patients equal to or greater than 2 years of age, ELIQUIS is not recommended in patients with an estimated glomerular filtration rate (eGFR) <30 mL/min/1.73 m² body surface area (BSA).

In patients less than 2 years of age, ELIQUIS is not recommended in patients with inadequate renal function defined by sex and postnatal age as used in the pediatric VTE trial for ELIQUIS (see Table 12 below).

To estimate GFR, the pediatric VTE trial for ELIQUIS used the updated Schwartz formula, eGFR (mL/min/1.73m²) = 0.413 * height (cm)/serum creatinine (mg/dL) for serum creatinine measured by an enzymatic creatinine method calibrated to be traceable to isotope dilution mass spectrometry (IDMS).

Table 12: Inadequate renal function by sex and post-natal age in pediatric patients <2 years of age as defined in the pediatric VTE trial for ELIQUIS

Postnatal age (gender)	Threshold eGFR used to define inadequate renal function (mL/min/1.73 m ²)
1 week (males and females)	<8
2–8 weeks (males and females)	<12
>8 weeks to <2 years (males and females)	<22

Inadequate renal function was defined as <30% of 1 standard deviation (SD) below normal GFR for age and size as determined by the updated Schwartz formula for ages up to 2 years. Beyond 2 years of age, the qualifying GFR for the pediatric VTE study was ≥30 mL/min/1.73m².

8.7 Hepatic Impairment

No dose adjustment is required in patients with mild hepatic impairment (Child-Pugh class A).

Because patients with moderate hepatic impairment (Child-Pugh class B) may have intrinsic coagulation abnormalities and there is limited clinical experience with ELIQUIS in these patients, dosing recommendations cannot be provided [see *Clinical Pharmacology (12.2)*].

ELIQUIS is not recommended in patients with severe hepatic impairment (Child-Pugh class C) [see *Clinical Pharmacology (12.2)*].

ELIQUIS has not been studied in pediatric patients with hepatic impairment.

10 OVERDOSAGE

Overdose of ELIQUIS increases the risk of bleeding [see *Warnings and Precautions (5.2)*].

In healthy subjects, administration of activated charcoal 2 and 6 hours after ingestion of a 20-mg dose of apixaban reduced mean apixaban AUC by 50% and 27%, respectively. Thus, administration of activated charcoal may be useful in the management of ELIQUIS overdose or accidental ingestion. An agent to reverse the anti-factor Xa activity of apixaban is available.

Consider contacting the Poison Help line (1-800-222-1222) or a medical toxicologist for additional overdose management recommendations.

11 DESCRIPTION

ELIQUIS (apixaban), a factor Xa (FXa) inhibitor, is chemically described as 1-(4-methoxyphenyl)-7-oxo-6-[4-(2-oxopiperidin-1-yl)phenyl]-4,5,6,7-tetrahydro-1H-pyrazolo[3,4-c]pyridine-3-carboxamide. Its molecular formula is $C_{25}H_{25}N_5O_4$, which corresponds to a molecular weight of 459.5. Apixaban has the following structural formula:

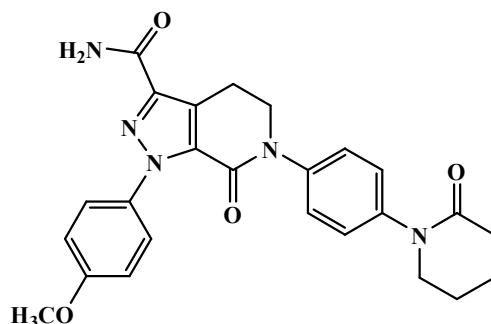

Apixaban is a white to pale-yellow powder. At physiological pH (1.2-6.8), apixaban does not ionize; its aqueous solubility across the physiological pH range is ~0.04 mg/mL.

ELIQUIS tablets 2.5 mg and 5 mg are available for oral administration and contain the following inactive ingredients: anhydrous lactose, microcrystalline cellulose, croscarmellose sodium, sodium lauryl sulfate, and magnesium stearate. The film coating contains lactose monohydrate, hypromellose, titanium dioxide, triacetin, and yellow iron oxide (2.5 mg tablets) or red iron oxide (5 mg tablets).

ELIQUIS 0.5 mg film coated tablets for oral suspension are supplied in packets containing 1 (0.5 mg), 3 (1.5 mg) or 4 (2 mg) apixaban tablets. The inactive ingredients are anhydrous lactose, microcrystalline cellulose, croscarmellose sodium, sodium lauryl sulfate, and magnesium stearate. The film coating contains lactose monohydrate, hypromellose, titanium dioxide, triacetin, and red iron oxide.

ELIQUIS SPRINKLE 0.15 mg for oral suspension is supplied as a white to off-white powder in capsules, which contain 0.15 mg apixaban and the following inactive ingredients: hypromellose and sugar spheres.

12 CLINICAL PHARMACOLOGY

12.1 Mechanism of Action

Apixaban is a selective inhibitor of FXa. It does not require antithrombin III for antithrombotic activity. Apixaban inhibits free and clot-bound FXa, and prothrombinase activity. Apixaban has no direct effect on platelet aggregation, but indirectly inhibits platelet aggregation induced by thrombin. By inhibiting FXa, apixaban decreases thrombin generation and thrombus development.

12.2 Pharmacodynamics

As a result of FXa inhibition, apixaban prolongs clotting tests such as prothrombin time (PT), INR, and activated partial thromboplastin time (aPTT). Changes observed in these clotting tests at the expected therapeutic dose, however, are small, subject to a high degree of variability, and not useful in monitoring the anticoagulation effect of apixaban.

The Rotachrom[®] Heparin chromogenic assay was used to measure the effect of apixaban on FXa activity in humans primarily during the apixaban adult development program. A concentration-dependent increase in anti-FXa activity was observed in the dose range tested and was similar in healthy subjects and patients with AF.

This test is not recommended for assessing the anticoagulant effect of apixaban.

Effect of PCCs on Pharmacodynamics of ELIQUIS

There is no clinical experience to reverse bleeding with the use of 4-factor PCC products in individuals who have received ELIQUIS.

Effects of 4-factor PCCs on the pharmacodynamics of apixaban were studied in healthy subjects. Following administration of apixaban dosed to steady state, endogenous thrombin potential (ETP) returned to pre-apixaban levels 4 hours after the initiation of a 30-minute PCC infusion, compared to 45 hours with placebo. Mean ETP levels continued to increase and exceeded pre-apixaban levels reaching a maximum (34%-51% increase over pre-apixaban levels) at 21 hours after initiating PCC and remained elevated (21%-27% increase) at the end of the study (69 hours after initiation of PCC). The clinical relevance of this increase in ETP is unknown.

Pharmacodynamic Drug Interaction Studies

Pharmacodynamic drug interaction studies with aspirin, clopidogrel, aspirin and clopidogrel, prasugrel, enoxaparin, and naproxen were conducted. No pharmacodynamic interactions were observed with aspirin, clopidogrel, or prasugrel [see *Warnings and Precautions (5.2)*]. A 50% to

60% increase in anti-FXa activity was observed when ELIQUIS was coadministered with enoxaparin or naproxen.

Specific Populations

Renal impairment: Anti-FXa activity adjusted for exposure to apixaban was similar across renal function categories.

Hepatic impairment: Changes in anti-FXa activity were similar in patients with mild-to-moderate hepatic impairment and healthy subjects. However, in patients with moderate hepatic impairment, there is no clear understanding of the impact of this degree of hepatic function impairment on the coagulation cascade and its relationship to efficacy and bleeding. Patients with severe hepatic impairment were not studied.

Pediatric patients: In pediatric patients treated with apixaban, the correlation between anti-FXa activity and plasma concentration is linear with a slope close to 1.

Cardiac Electrophysiology

Apixaban has no effect on the QTc interval in humans at doses up to 50 mg.

12.3 Pharmacokinetics

Apixaban demonstrates linear pharmacokinetics with dose-proportional increases in exposure for oral doses up to 10 mg.

Absorption

The absolute bioavailability of apixaban is approximately 50% for doses up to 10 mg of ELIQUIS. Food does not affect the bioavailability of apixaban. Maximum concentrations (C_{max}) of apixaban appear 3 to 4 hours after oral administration of ELIQUIS. At doses ≥ 25 mg, apixaban displays dissolution-limited absorption with decreased bioavailability. Following oral administration of 10 mg of apixaban as 2 crushed 5 mg tablets suspended in 30 mL of water, exposure was similar to that after oral administration of 2 intact 5 mg tablets. Following oral administration of 10 mg of apixaban as 2 crushed 5 mg tablets mixed with 30 g of applesauce, the C_{max} and AUC were 20% and 16% lower, respectively, when compared to administration of 2 intact 5 mg tablets. Following administration of a crushed 5 mg ELIQUIS tablet that was suspended in 60 mL D5W and delivered through a nasogastric tube, exposure was similar to that seen in other clinical trials involving healthy volunteers receiving a single oral 5 mg tablet dose.

Distribution

Plasma protein binding in humans is approximately 87%. The volume of distribution (V_{ss}) is approximately 21 liters.

Metabolism

Approximately 25% of an orally administered apixaban dose is recovered in urine and feces as metabolites. Apixaban is metabolized mainly via CYP3A4 with minor contributions from CYP1A2, 2C8, 2C9, 2C19, and 2J2. O-demethylation and hydroxylation at the 3-oxopiperidinyl moiety are the major sites of biotransformation.

Unchanged apixaban is the major drug-related component in human plasma; there are no active circulating metabolites.

Elimination

Apixaban is eliminated in both urine and feces. Renal excretion accounts for about 27% of total clearance. Biliary and direct intestinal excretion contributes to elimination of apixaban in the feces.

Apixaban has a total clearance of approximately 3.3 L/hour and an apparent half-life of approximately 12 hours following oral administration.

Apixaban is a substrate of transport proteins: P-gp and breast cancer resistance protein.

Drug Interaction Studies

In *in vitro* apixaban studies at concentrations significantly greater than therapeutic exposures, no inhibitory effect on the activity of CYP1A2, CYP2A6, CYP2B6, CYP2C8, CYP2C9, CYP2D6, CYP3A4/5, or CYP2C19, nor induction effect on the activity of CYP1A2, CYP2B6, or CYP3A4/5 were observed. Therefore, apixaban is not expected to alter the metabolic clearance of coadministered drugs that are metabolized by these enzymes. Apixaban is not a significant inhibitor of P-gp.

The effects of coadministered drugs on the pharmacokinetics of apixaban are summarized in Figure 2 [see also *Warnings and Precautions (5.2) and Drug Interactions (7)*].

Figure 2: Effect of Coadministered Drugs on the Pharmacokinetics of Apixaban

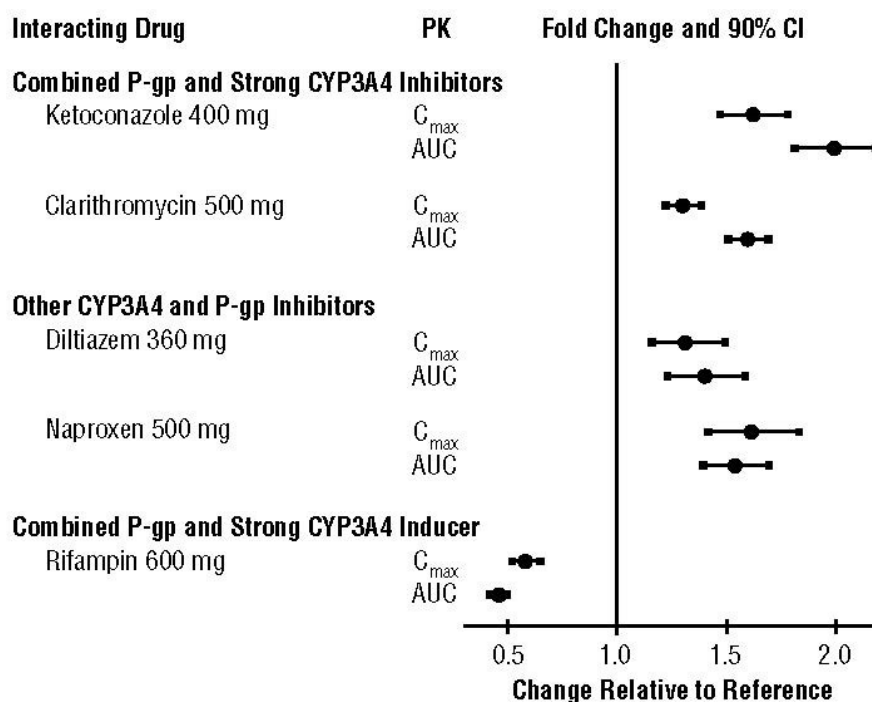

In dedicated studies conducted in healthy subjects, famotidine, atenolol, prasugrel, and enoxaparin did not meaningfully alter the pharmacokinetics of apixaban.

In studies conducted in healthy subjects, apixaban did not meaningfully alter the pharmacokinetics of digoxin, naproxen, atenolol, prasugrel, or acetylsalicylic acid.

Specific Populations

The effects of level of renal impairment, age, body weight, and level of hepatic impairment on the pharmacokinetics of apixaban are summarized in Figure 3.

Figure 3: Effect of Specific Populations on the Pharmacokinetics of Apixaban

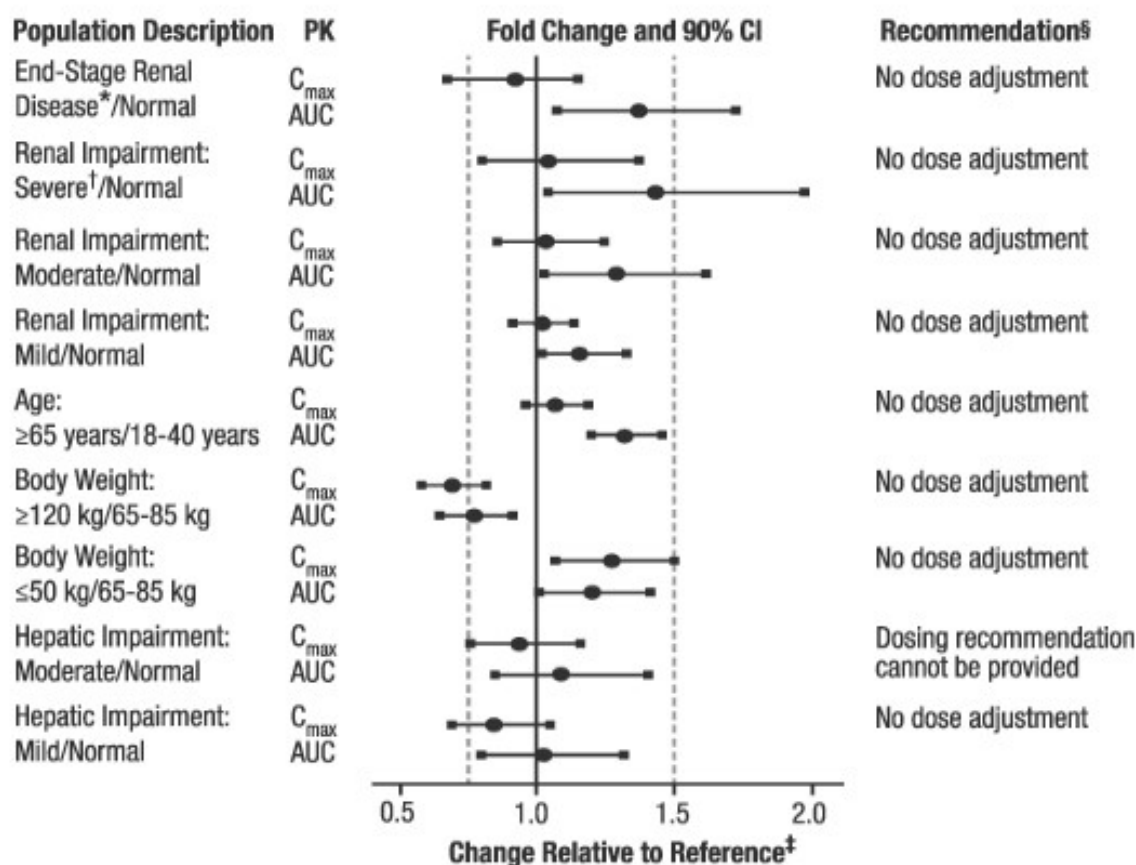

* ESRD subjects treated with intermittent hemodialysis; reported PK findings are following single dose of apixaban posthemodialysis.

† Results reflect CrCl of 15 mL/min based on regression analysis.

‡ Dashed vertical lines illustrate pharmacokinetic changes that were used to inform dosing recommendations.

§ No dose adjustment is recommended for nonvalvular atrial fibrillation patients unless at least 2 of the following patient characteristics (age greater than or equal to 80 years, body weight less than or equal to 60 kg, or serum creatinine greater than or equal to 1.5 mg/dL) are present.

Gender: A study in healthy subjects comparing the pharmacokinetics in males and females showed no meaningful difference.

Race: The results across pharmacokinetic studies in normal subjects showed no differences in apixaban pharmacokinetics among White/Caucasian, Asian, and Black/African American subjects. No dose adjustment is required based on race/ethnicity.

Hemodialysis in ESRD subjects: Systemic exposure to apixaban administered as a single 5 mg dose in ESRD subjects dosed immediately after the completion of a 4-hour hemodialysis session (postdialysis) is 36% higher when compared to subjects with normal renal function (Figure 3). The systemic exposure to apixaban administered 2 hours prior to a 4-hour hemodialysis session with a dialysate flow rate of 500 mL/min and a blood flow rate in the range of 350 to 500 mL/min is 17% higher compared to those with normal renal function. The dialysis clearance of apixaban is approximately 18 mL/min. The systemic exposure of apixaban is 14% lower on dialysis when compared to not on dialysis.

Protein binding was similar (92%-94%) between healthy controls and ESRD subjects during the on-dialysis and off-dialysis periods.

Pediatric Patients: Apixaban reached maximum concentration (C_{max}) in pediatric patients approximately 2 hours after single-dose administration. In pediatric patients, apixaban has a total apparent clearance of about 3.0 L/h.

An exploratory analysis in pediatric patients did not reveal relevant differences in apixaban exposure based on gender or race.

13 NONCLINICAL TOXICOLOGY

13.1 Carcinogenesis, Mutagenesis, Impairment of Fertility

Carcinogenesis: Apixaban was not carcinogenic when administered to mice and rats for up to 2 years. The systemic exposures (AUCs) of unbound apixaban in male and female mice at the highest doses tested (1500 and 3000 mg/kg/day) were 9 and 20 times, respectively, the human exposure of unbound drug at the MRHD of 10 mg/day. Systemic exposures of unbound apixaban in male and female rats at the highest dose tested (600 mg/kg/day) were 2 and 4 times, respectively, the human exposure.

Mutagenesis: Apixaban was neither mutagenic in the bacterial reverse mutation (Ames) assay, nor clastogenic in Chinese hamster ovary cells *in vitro*, in a 1-month *in vivo/in vitro* cytogenetics study in rat peripheral blood lymphocytes, or in a rat micronucleus study *in vivo*.

Impairment of Fertility: Apixaban had no effect on fertility in male or female rats when given at doses up to 600 mg/kg/day, a dose resulting in unbound apixaban exposure levels that are 3 and 4 times, respectively, the human exposure.

Apixaban administered to female rats at doses up to 1000 mg/kg/day from implantation through the end of lactation produced no adverse findings in male offspring (F1 generation) at doses up to 1000 mg/kg/day, a dose resulting in exposure to unbound apixaban that is 5 times the human exposure. Adverse effects in the F1-generation female offspring were limited to decreased mating and fertility indices at ≥ 200 mg/kg/day (a dose resulting in exposure to unbound apixaban that is ≥ 5 times the human exposure).

14 CLINICAL STUDIES

14.1 Reduction of Risk of Stroke and Systemic Embolism in Nonvalvular Atrial Fibrillation

ARISTOTLE

Evidence for the efficacy and safety of ELIQUIS was derived from ARISTOTLE, a multinational, double-blind study in patients with nonvalvular AF comparing the effects of ELIQUIS and warfarin on the risk of stroke and non-central nervous system (CNS) systemic embolism. In ARISTOTLE, patients were randomized to ELIQUIS 5 mg orally twice daily (or 2.5 mg twice daily in subjects with at least 2 of the following characteristics: age greater than or equal to 80 years, body weight less than or equal to 60 kg, or serum creatinine greater than or equal to 1.5 mg/dL) or to warfarin (targeted to an INR range of 2.0-3.0). Patients had to have one or more of the following additional risk factors for stroke:

- prior stroke or transient ischemic attack (TIA)
- prior systemic embolism
- age greater than or equal to 75 years
- arterial hypertension requiring treatment
- diabetes mellitus
- heart failure \geq New York Heart Association Class 2
- left ventricular ejection fraction \leq 40%

The primary objective of ARISTOTLE was to determine whether ELIQUIS 5 mg twice daily (or 2.5 mg twice daily) was effective (noninferior to warfarin) in reducing the risk of stroke (ischemic or hemorrhagic) and systemic embolism. Superiority of ELIQUIS to warfarin was also examined for the primary endpoint (rate of stroke and systemic embolism), major bleeding, and death from any cause.

A total of 18,201 patients were randomized and followed on study treatment for a median of 89 weeks. Forty-three percent of patients were vitamin K antagonist (VKA) “naive,” defined as having received \leq 30 consecutive days of treatment with warfarin or another VKA before entering the study. The mean age was 69 years and the mean CHADS₂ score (a scale from 0 to 6 used to estimate risk of stroke, with higher scores predicting greater risk) was 2.1. The population was 65% male, 83% Caucasian, 14% Asian, and 1% Black. There was a history of stroke, TIA, or non-CNS systemic embolism in 19% of patients. Concomitant diseases of patients in this study included hypertension 88%, diabetes 25%, congestive heart failure (or left ventricular ejection fraction \leq 40%) 35%, and prior myocardial infarction 14%. Patients treated with warfarin in ARISTOTLE had a mean percentage of time in therapeutic range (INR 2.0-3.0) of 62%.

ELIQUIS was superior to warfarin for the primary endpoint of reducing the risk of stroke and systemic embolism (Table 13 and Figure 4). Superiority to warfarin was primarily attributable to a reduction in hemorrhagic stroke and ischemic strokes with hemorrhagic conversion compared to warfarin. Purely ischemic strokes occurred with similar rates on both drugs.

ELIQUIS also showed significantly fewer major bleeds than warfarin [see Adverse Reactions (6.1)].

Table 13: Key Efficacy Outcomes in Patients with Nonvalvular Atrial Fibrillation in ARISTOTLE (Intent-to-Treat Analysis)

	ELIQUIS N=9120 n (%/year)	Warfarin N=9081 n (%/year)	Hazard Ratio (95% CI)	P-value
Stroke or systemic embolism	212 (1.27)	265 (1.60)	0.79 (0.66, 0.95)	0.01
Stroke	199 (1.19)	250 (1.51)	0.79 (0.65, 0.95)	
Ischemic without hemorrhage	140 (0.83)	136 (0.82)	1.02 (0.81, 1.29)	
Ischemic with hemorrhagic conversion	12 (0.07)	20 (0.12)	0.60 (0.29, 1.23)	
Hemorrhagic	40 (0.24)	78 (0.47)	0.51 (0.35, 0.75)	
Unknown	14 (0.08)	21 (0.13)	0.65 (0.33, 1.29)	
Systemic embolism	15 (0.09)	17 (0.10)	0.87 (0.44, 1.75)	

The primary endpoint was based on the time to first event (one per subject). Component counts are for subjects with any event, not necessarily the first.

Figure 4: Kaplan-Meier Estimate of Time to First Stroke or Systemic Embolism in ARISTOTLE (Intent-to-Treat Population)

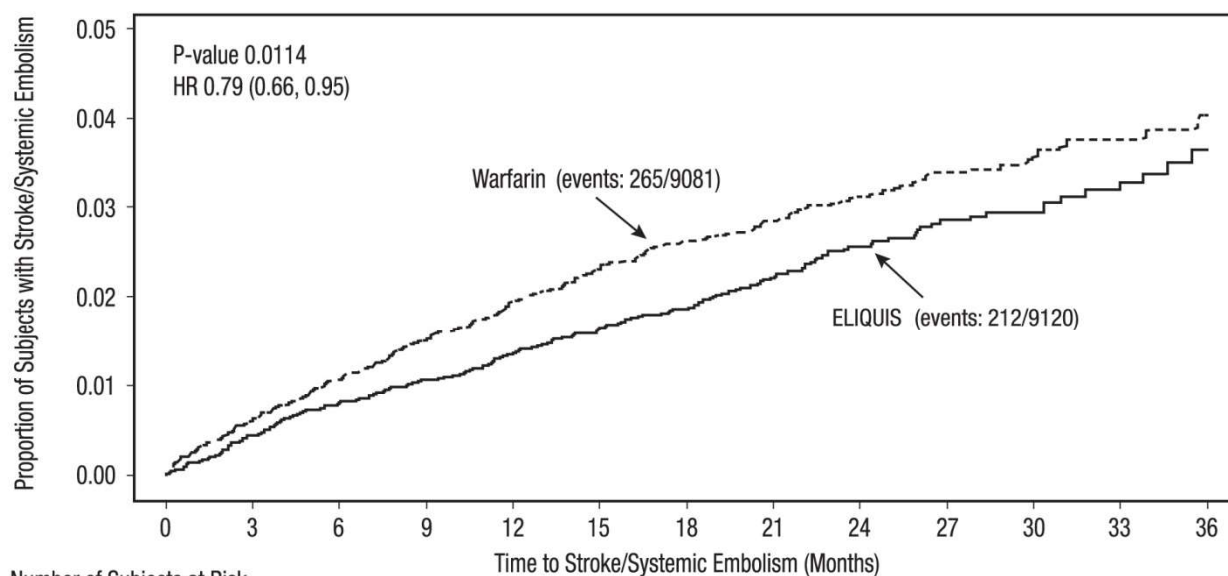

All-cause death was assessed using a sequential testing strategy that allowed testing for superiority if effects on earlier endpoints (stroke plus systemic embolus and major bleeding) were demonstrated. ELIQUIS treatment resulted in a significantly lower rate of all-cause death ($p = 0.046$) than did treatment with warfarin, primarily because of a reduction in cardiovascular death, particularly stroke deaths. Non-vascular death rates were similar in the treatment arms.

In ARISTOTLE, the results for the primary efficacy endpoint were generally consistent across most major subgroups including weight, CHADS₂ score (a scale from 0 to 6 used to predict risk of stroke in patients with AF, with higher scores predicting greater risk), prior warfarin use, level of renal impairment, geographic region, and aspirin use at randomization (Figure 5).

Figure 5: Stroke and Systemic Embolism Hazard Ratios by Baseline Characteristics – ARISTOTLE Study

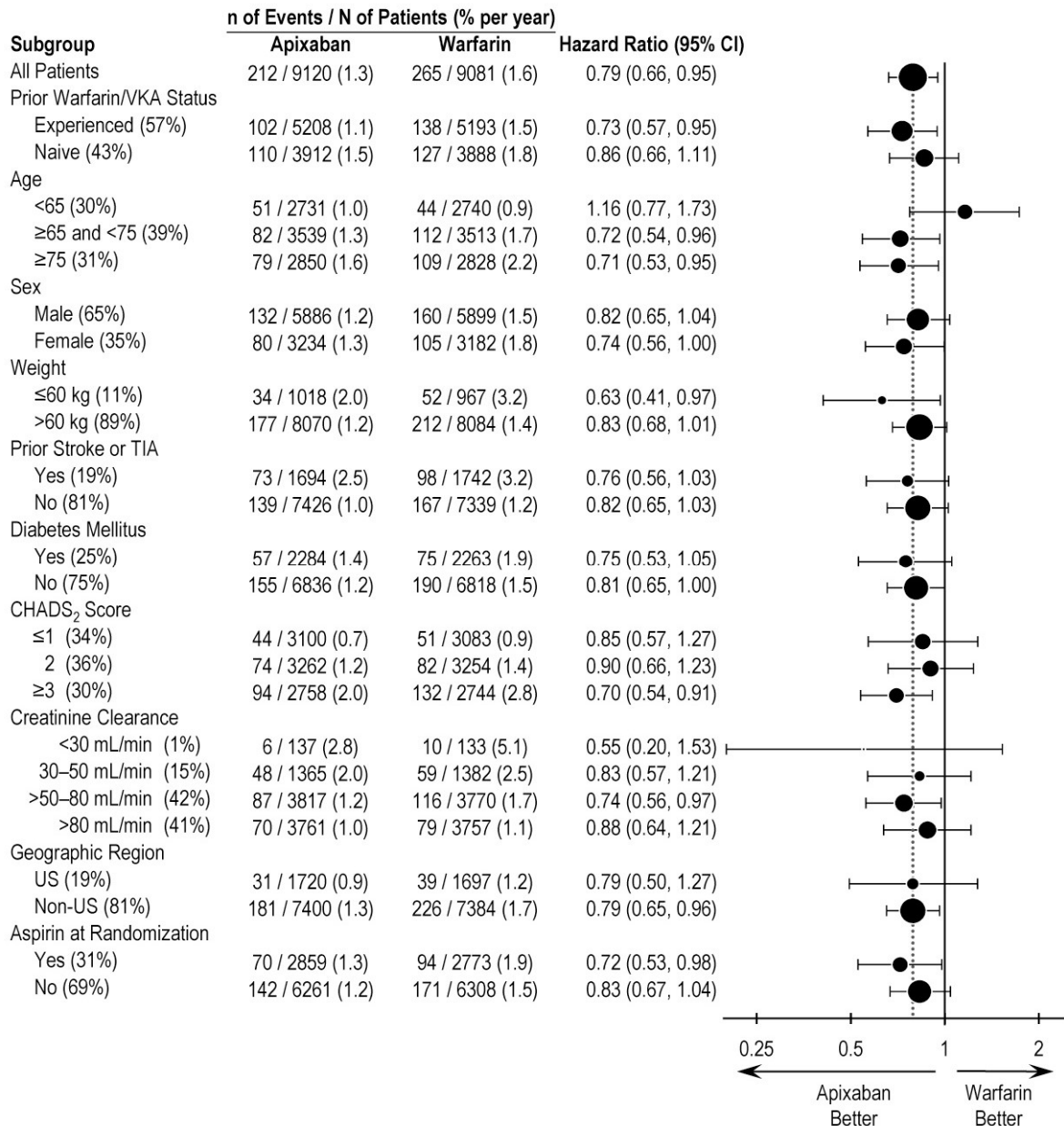

Note: The figure above presents effects in various subgroups, all of which are baseline characteristics and all of which were prespecified, if not the groupings. The 95% confidence limits that are shown do not take into account how many comparisons were made, nor do they reflect the effect of a particular factor after adjustment for all other factors. Apparent homogeneity or heterogeneity among groups should not be over-interpreted.

At the end of the ARISTOTLE study, warfarin patients who completed the study were generally maintained on a VKA with no interruption of anticoagulation. ELIQUIS patients who completed the study were generally switched to a VKA with a 2-day period of coadministration of ELIQUIS and VKA, so that some patients may not have been adequately anticoagulated after stopping ELIQUIS until attaining a stable and therapeutic INR. During the 30 days following the end of the study, there were 21 stroke or systemic embolism events in the 6791 patients (0.3%) in the ELIQUIS arm compared to 5 in the 6569 patients (0.1%) in the warfarin arm [see *Dosage and Administration* (2.4)].

AVERROES

In AVERROES, patients with nonvalvular atrial fibrillation thought not to be candidates for warfarin therapy were randomized to treatment with ELIQUIS 5 mg orally twice daily (or 2.5 mg twice daily in selected patients) or aspirin 81 to 324 mg once daily. The primary objective of the study was to determine if ELIQUIS was superior to aspirin for preventing the composite outcome of stroke or systemic embolism. AVERROES was stopped early on the basis of a prespecified interim analysis showing a significant reduction in stroke and systemic embolism for ELIQUIS compared to aspirin that was associated with a modest increase in major bleeding (Table 14) [see *Adverse Reactions* (6.1)].

Table 14: Key Efficacy Outcomes in Patients with Nonvalvular Atrial Fibrillation in AVERROES

	ELIQUIS N=2807 n (%/year)	Aspirin N=2791 n (%/year)	Hazard Ratio (95% CI)	P-value
Stroke or systemic embolism	51 (1.62)	113 (3.63)	0.45 (0.32, 0.62)	<0.0001
Stroke				
Ischemic or undetermined	43 (1.37)	97 (3.11)	0.44 (0.31, 0.63)	-
Hemorrhagic	6 (0.19)	9 (0.28)	0.67 (0.24, 1.88)	-
Systemic embolism	2 (0.06)	13 (0.41)	0.15 (0.03, 0.68)	-
MI	24 (0.76)	28 (0.89)	0.86 (0.50, 1.48)	-
All-cause death	111 (3.51)	140 (4.42)	0.79 (0.62, 1.02)	0.068
Vascular death	84 (2.65)	96 (3.03)	0.87 (0.65, 1.17)	-

14.2 Prophylaxis of Deep Vein Thrombosis Following Hip or Knee Replacement Surgery

The clinical evidence for the effectiveness of ELIQUIS is derived from the ADVANCE-1, ADVANCE-2, and ADVANCE-3 clinical trials in adult patients undergoing elective hip (ADVANCE-3) or knee (ADVANCE-2 and ADVANCE-1) replacement surgery. A total of 11,659 patients were randomized in 3 double-blind, multi-national studies. Included in this total were 1866 patients age 75 or older, 1161 patients with low body weight (≤ 60 kg), 2528 patients with Body Mass Index ≥ 33 kg/m², and 625 patients with severe or moderate renal impairment.

In the ADVANCE-3 study, 5407 patients undergoing elective hip replacement surgery were randomized to receive either ELIQUIS 2.5 mg orally twice daily or enoxaparin 40 mg subcutaneously once daily. The first dose of ELIQUIS was given 12 to 24 hours post surgery, whereas enoxaparin was started 9 to 15 hours prior to surgery. Treatment duration was 32 to 38 days.

In patients undergoing elective knee replacement surgery, ELIQUIS 2.5 mg orally twice daily was compared to enoxaparin 40 mg subcutaneously once daily (ADVANCE-2, N=3057) or enoxaparin 30 mg subcutaneously every 12 hours (ADVANCE-1, N=3195). In the ADVANCE-2 study, the first dose of ELIQUIS was given 12 to 24 hours postsurgery, whereas enoxaparin was started 9 to 15 hours prior to surgery. In the ADVANCE-1 study, both ELIQUIS and enoxaparin were initiated 12 to 24 hours post surgery. Treatment duration in both ADVANCE-2 and ADVANCE-1 was 10 to 14 days.

In all 3 studies, the primary endpoint was a composite of adjudicated asymptomatic and symptomatic DVT, nonfatal PE, and all-cause death at the end of the double-blind intended treatment period. In ADVANCE-3 and ADVANCE-2, the primary endpoint was tested for noninferiority, then superiority, of ELIQUIS to enoxaparin. In ADVANCE-1, the primary endpoint was tested for noninferiority of ELIQUIS to enoxaparin.

The efficacy data are provided in Tables 15 and 16.

Table 15: Summary of Key Efficacy Analysis Results During the Intended Treatment Period for Patients Undergoing Elective Hip Replacement Surgery*

Events During 35-Day Treatment Period	ADVANCE-3		Relative Risk (95% CI) P-value
	ELIQUIS 2.5 mg po bid	Enoxaparin 40 mg sc qd	
Number of Patients	N=1949	N=1917	
Total VTE [†] /All-cause death	27 (1.39%) (0.95, 2.02)	74 (3.86%) (3.08, 4.83)	0.36 (0.22, 0.54) p<0.0001
Number of Patients	N=2708	N=2699	
All-cause death	3 (0.11%) (0.02, 0.35)	1 (0.04%) (0.00, 0.24)	
PE	3 (0.11%) (0.02, 0.35)	5 (0.19%) (0.07, 0.45)	
Symptomatic DVT	1 (0.04%) (0.00, 0.24)	5 (0.19%) (0.07, 0.45)	
Number of Patients	N=2196	N=2190	
Proximal DVT [‡]	7 (0.32%) (0.14, 0.68)	20 (0.91%) (0.59, 1.42)	
Number of Patients	N=1951	N=1908	

Table 15: Summary of Key Efficacy Analysis Results During the Intended Treatment Period for Patients Undergoing Elective Hip Replacement Surgery*

	ADVANCE-3	
Distal DVT [‡]	20 (1.03%) (0.66, 1.59)	57 (2.99%) (2.31, 3.86)

* Events associated with each endpoint were counted once per subject but subjects may have contributed events to multiple endpoints.

[†] Total VTE includes symptomatic and asymptomatic DVT and PE.

[‡] Includes symptomatic and asymptomatic DVT.

Table 16: Summary of Key Efficacy Analysis Results During the Intended Treatment Period for Patients Undergoing Elective Knee Replacement Surgery*

	ADVANCE-1			ADVANCE-2		
Events during 12-day treatment period	ELIQUIS 2.5 mg po bid	Enoxaparin 30 mg sc q12h	Relative Risk (95% CI) P-value	ELIQUIS 2.5 mg po bid	Enoxaparin 40 mg sc qd	Relative Risk (95% CI) P-value
Number of Patients	N=1157	N=1130		N=976	N=997	
Total VTE [†] /All-cause death	104 (8.99%) (7.47, 10.79)	100 (8.85%) (7.33, 10.66)	1.02 (0.78, 1.32) NS	147 (15.06%) (12.95, 17.46)	243 (24.37%) (21.81, 27.14)	0.62 (0.51, 0.74) p<0.0001
Number of Patients	N=1599	N=1596		N=1528	N=1529	
All-cause death	3 (0.19%) (0.04, 0.59)	3 (0.19%) (0.04, 0.59)		2 (0.13%) (0.01, 0.52)	0 (0%) (0.00, 0.31)	
PE	16 (1.0%) (0.61, 1.64)	7 (0.44%) (0.20, 0.93)		4 (0.26%) (0.08, 0.70)	0 (0%) (0.00, 0.31)	
Symptomatic DVT	3 (0.19%) (0.04, 0.59)	7 (0.44%) (0.20, 0.93)		3 (0.20%) (0.04, 0.61)	7 (0.46%) (0.20, 0.97)	
Number of Patients	N=1254	N=1207		N=1192	N=1199	
Proximal DVT [‡]	9 (0.72%) (0.36, 1.39)	11 (0.91%) (0.49, 1.65)		9 (0.76%) (0.38, 1.46)	26 (2.17%) (1.47, 3.18)	
Number of Patients	N=1146	N=1133		N=978	N=1000	
Distal DVT [‡]	83 (7.24%) (5.88, 8.91)	91 (8.03%) (6.58, 9.78)		142 (14.52%) (12.45, 16.88)	239 (23.9%) (21.36, 26.65)	

* Events associated with each endpoint were counted once per subject but subjects may have contributed events to multiple endpoints.

[†] Total VTE includes symptomatic and asymptomatic DVT and PE.

[‡] Includes symptomatic and asymptomatic DVT.

The efficacy profile of ELIQUIS was generally consistent across subgroups of interest for this indication (e.g., age, gender, race, body weight, renal impairment).

14.3 Treatment of DVT and PE and Reduction in the Risk of Recurrence of DVT and PE

Efficacy and safety of ELIQUIS for the treatment of DVT and PE, and for the reduction in the risk of recurrent DVT and PE following 6 to 12 months of anticoagulant treatment was derived from the AMPLIFY and AMPLIFY-EXT studies. Both studies were randomized, parallel-group, double-blind trials in patients with symptomatic proximal DVT and/or symptomatic PE. All key safety and efficacy endpoints were adjudicated in a blinded manner by an independent committee.

AMPLIFY

The primary objective of AMPLIFY was to determine whether ELIQUIS was noninferior to enoxaparin/warfarin for the incidence of recurrent VTE (venous thromboembolism) or VTE-related death. Patients with an objectively confirmed symptomatic DVT and/or PE were randomized to treatment with ELIQUIS 10 mg twice daily orally for 7 days followed by ELIQUIS 5 mg twice daily orally for 6 months, or enoxaparin 1 mg/kg twice daily subcutaneously for at least 5 days (until INR ≥ 2) followed by warfarin (target INR range 2.0-3.0) orally for 6 months. Patients who required thrombectomy, insertion of a caval filter, or use of a fibrinolytic agent, and patients with creatinine clearance < 25 mL/min, significant liver disease, an existing heart valve or atrial fibrillation, or active bleeding were excluded from the AMPLIFY study. Patients were allowed to enter the study with or without prior parenteral anticoagulation (up to 48 hours).

A total of 5244 patients were evaluable for efficacy and were followed for a mean of 154 days in the ELIQUIS group and 152 days in the enoxaparin/warfarin group. The mean age was 57 years. The AMPLIFY study population was 59% male, 83% Caucasian, 8% Asian, and 4% Black. For patients randomized to warfarin, the mean percentage of time in therapeutic range (INR 2.0-3.0) was 60.9%.

Approximately 90% of patients enrolled in AMPLIFY had an unprovoked DVT or PE at baseline. The remaining 10% of patients with a provoked DVT or PE were required to have an additional ongoing risk factor in order to be randomized, which included previous episode of DVT or PE, immobilization, history of cancer, active cancer, and known prothrombotic genotype.

ELIQUIS was shown to be noninferior to enoxaparin/warfarin in the AMPLIFY study for the primary endpoint of recurrent symptomatic VTE (nonfatal DVT or nonfatal PE) or VTE-related death over 6 months of therapy (Table 17).

Table 17: Efficacy Results in the AMPLIFY Study

	ELIQUIS N=2609 n	Enoxaparin/Warfarin N=2635 n	Relative Risk (95% CI)
VTE or VTE-related death*	59 (2.3%)	71 (2.7%)	0.84 (0.60, 1.18)
DVT†	22 (0.8%)	35 (1.3%)	

Table 17: Efficacy Results in the AMPLIFY Study

	ELIQUIS N=2609 n	Enoxaparin/Warfarin N=2635 n	Relative Risk (95% CI)
PE [†]	27 (1.0%)	25 (0.9%)	
VTE-related death [†]	12 (0.4%)	16 (0.6%)	
VTE or all-cause death	84 (3.2%)	104 (4.0%)	0.82 (0.61, 1.08)
VTE or CV-related death	61 (2.3%)	77 (2.9%)	0.80 (0.57, 1.11)

* Noninferior compared to enoxaparin/warfarin (P-value <0.0001).

[†] Events associated with each endpoint were counted once per subject, but subjects may have contributed events to multiple endpoints.

In the AMPLIFY study, patients were stratified according to their index event of PE (with or without DVT) or DVT (without PE). Efficacy in the initial treatment of VTE was consistent between the two subgroups.

AMPLIFY-EXT

Patients who had been treated for DVT and/or PE for 6 to 12 months with anticoagulant therapy without having a recurrent event were randomized to treatment with ELIQUIS 2.5 mg orally twice daily, ELIQUIS 5 mg orally twice daily, or placebo for 12 months. Approximately one-third of patients participated in the AMPLIFY study prior to enrollment in the AMPLIFY-EXT study.

A total of 2482 patients were randomized to study treatment and were followed for a mean of approximately 330 days in the ELIQUIS group and 312 days in the placebo group. The mean age in the AMPLIFY-EXT study was 57 years. The study population was 57% male, 85% Caucasian, 5% Asian, and 3% Black.

The AMPLIFY-EXT study enrolled patients with either an unprovoked DVT or PE at baseline (approximately 92%) or patients with a provoked baseline event and one additional risk factor for recurrence (approximately 8%). However, patients who had experienced multiple episodes of unprovoked DVT or PE were excluded from the AMPLIFY-EXT study. In the AMPLIFY-EXT study, both doses of ELIQUIS were superior to placebo in the primary endpoint of symptomatic, recurrent VTE (nonfatal DVT or nonfatal PE), or all-cause death (Table 18).

Table 18: Efficacy Results in the AMPLIFY-EXT Study

				Relative Risk (95% CI)	
	ELIQUIS 2.5 mg bid N=840	ELIQUIS 5 mg bid N=813	Placebo N=829	ELIQUIS 2.5 mg bid vs Placebo	ELIQUIS 5 mg bid vs Placebo
	n (%)				
Recurrent VTE or all-cause death	32 (3.8)	34 (4.2)	96 (11.6)	0.33 (0.22, 0.48) p<0.0001	0.36 (0.25, 0.53) p<0.0001
DVT*	19 (2.3)	28 (3.4)	72 (8.7)		

Table 18: Efficacy Results in the AMPLIFY-EXT Study

	ELIQUIS 2.5 mg bid N=840	ELIQUIS 5 mg bid N=813	Placebo N=829	Relative Risk (95% CI)	
				ELIQUIS 2.5 mg bid vs Placebo	ELIQUIS 5 mg bid vs Placebo
PE*	23 (2.7)	25 (3.1)	37 (4.5)		
All-cause death	22 (2.6)	25 (3.1)	33 (4.0)		

* Patients with more than one event are counted in multiple rows.

14.4 Treatment of VTE and Prevention of Recurrent VTE in Pediatric Patients from birth and older

Study CV185325

ELIQUIS for the treatment of venous thromboembolism (VTE) and reduction in the risk of recurrent VTE was evaluated in Study CV185325, a multicenter, randomized, active-controlled, open-label, multi-center study in 229 pediatric patients from birth to less than 18 years with confirmed VTE. This was a descriptive study and no formal inferences were performed. There were 137 patients aged 12 to < 18 years, 44 patients aged 2 to < 12 years, 32 patients aged 28 days to less than 2 years and 16 patients from birth to less than 27 days. Overall, the median age was 14.2 years with a range of 0.04 to 18.0 years. Neonates and infants were excluded from enrollment if they were < 34 weeks' gestation (until age of > 6 months) or had a body weight of < 2.6 kg. For pre-term infants born between 34 and <37 weeks gestation, neonates who reached 37 weeks starting from actual date of birth (postnatal age), from 27 day neonatal period starting from actual date of birth (postnatal age), or from when the postmenstrual age (gestational age defined as time elapsed between first day of last normal menstrual period and the day of delivery plus postnatal age) and enrolled the neonate no more than 27 days thereafter. There were 101 (44.1%) males, and 128 (55.9%) females in the study. One hundred and seventy-five (76.4%) patients were White, 31 (13.5%) were Black, 9 (3.9%) were Asian, 4 (1.7%) were Other, 2 (0.9%) were Multiracial and 1 (0.4%) was American Indian or Alaska Native, and 7 (3.1%) were missing this information. Twenty-five (10.9%) were Hispanic or Latino and 204 (89.1%) were not Hispanic or Latino.

Index VTE was classified as deep venous thrombosis (DVT), pulmonary embolism (PE), device-related thrombosis (neonatal population only), and other VTE (i.e. cerebral vein and sinus thrombosis, renal vein thrombosis, intracardiac thrombus). Prior to randomization, patients could be treated with SOC anticoagulation for up to 14 days; overall mean (SD) duration of treatment with SOC anticoagulation prior to randomization was 4.9 (2.6) days, and for 92.9% of patients the duration was between 0 and 7 days. Patients were randomized according to a 2:1 ratio to receive either an age-appropriate formulation and body weight-adjusted doses of ELIQUIS or SOC. For patients 2 to less than 18 years, SOC was comprised of low molecular weight heparins (LMWH), unfractionated heparins (UFH) or vitamin K antagonists (VKA). For patients 28 days to less than 2 years of age, SOC was limited to heparins (UFH or LMWH). The main treatment phase lasted 6 to 12 weeks for patients aged birth to less than 2 years, and 12 weeks for patients aged greater than

2 years. Patients aged 28 days to less than 18 years who were randomized to receive apixaban had the option to continue apixaban treatment for 6 to 12 additional weeks in the extension phase.

A diagnostic imaging test was obtained at baseline, at week 6, and end of treatment for patients ≥ 2 years of age and at baseline and end of treatment for < 2 years of age.

Table 19: Primary efficacy results from Study CV185325

	ELIQUIS N=155	Standard of care ** N=74
Symptomatic and asymptomatic recurrent VTE* and VTE* related mortality***		
Number (%) Subjects with Event	4 (2.6)	2 (2.7)
95% Confidence Interval (1)	(0.7, 6.5)	(0.3, 9.4)

* Recurrent VTE, defined as either contiguous progression or non-contiguous new thrombus and including, but not limited to DVT, PE and paradoxical embolism.

(1) 95% Confidence Interval calculated using the Clopper-Pearson exact method

** UFH/LMWH for patients less than 2 years of age and UFH/LMWH/VKA for those equal to or greater than 2 years of age.

*** no VTE related mortality was observed in either treatment arms during the study.

16 HOW SUPPLIED/STORAGE AND HANDLING

How Supplied

ELIQUIS (apixaban) tablets for oral use, ELIQUIS (apixaban) tablets for oral suspension, and ELIQUIS SPRINKLE (apixaban) for oral suspension are available as listed in the table below.

Strength	Dosage form/Description	Markings	Package Size	NDC Code
0.15 mg	Powder In a yellow, opaque capsule	Printed with “898”	Bottles of 28	0003-0898-28
0.5 mg	Film-coated Tablet for oral suspension, Pink, round	N/A	Carton of 28 packets 28 count tablet carton (1 tablet per packet) 84 count tablet carton (3 tablets per packet) 112 count tablet carton (4 tablets per packet)	0003-1028-28 0003-3084-28 0003-4112-28
2.5 mg	Film-coated Tablet Yellow, round, biconvex	Debossed with “893” on one side and “2½” on the other side	Bottles of 60 Hospital Unit-Dose Blister Package of 100	0003-0893-21 0003-0893-31
5 mg	Film-coated Tablet Pink, oval, biconvex	Debossed with “894” on one side and “5” on the other side	Bottles of 60 Bottles of 74 Hospital Unit-Dose Blister Package of 100	0003-0894-21 0003-0894-70 0003-0894-31

Strength	Dosage form/Description	Markings	Package Size	NDC Code
0.15 mg	Powder In a yellow, opaque capsule	Printed with “898”	Bottles of 28	0003-0898-28
0.5 mg	Film-coated Tablet for oral suspension, Pink, round	N/A	Carton of 28 packets 28 count tablet carton (1 tablet per packet) 84 count tablet carton (3 tablets per packet) 112 count tablet carton (4 tablets per packet)	0003-1028-28 0003-3084-28 0003-4112-28
			30-Day Starter Pack for Treatment of DVT and PE Containing 74 Tablets (1 blister pack of 42 tablets and 1 blister pack of 32 tablets)	0003-3764-74

Storage and Handling

Store ELIQUIS and ELIQUIS SPRINKLE at 20°C to 25°C (68°F to 77°F); excursions permitted between 15°C to 30°C (59°F to 86°F) [see USP Controlled Room Temperature].

17 PATIENT COUNSELING INFORMATION

Advise patients to read the FDA-approved patient labeling (Medication Guide and Instructions for Use).

Advise patients of the following:

- Not to discontinue ELIQUIS without talking to their physician first.
- That it might take longer than usual for bleeding to stop, and they may bruise or bleed more easily when treated with ELIQUIS. Advise patients about how to recognize bleeding or symptoms of hypovolemia and of the urgent need to report any unusual bleeding to their physician.
- To tell their physicians and dentists they are taking ELIQUIS, and/or any other product known to affect bleeding (including nonprescription products, such as aspirin or NSAIDs), before any surgery or medical or dental procedure is scheduled and before any new drug is taken.
- If the patient is having neuraxial anesthesia or spinal puncture, inform the patient to watch for signs and symptoms of spinal or epidural hematomas [see *Warnings and Precautions (5.3)*]. If any of these symptoms occur, advise the patient to seek emergent medical attention.
- To tell their physicians if they are pregnant or plan to become pregnant or are breastfeeding or intend to breastfeed during treatment with ELIQUIS [see *Use in Specific Populations (8.1, 8.2)*].
- How to take ELIQUIS if they cannot swallow or require a nasogastric tube [see *Dosage and Administration (2.7)*].
- What to do if a dose is missed [see *Dosage and Administration (2.2 and 2.3)*].

Pediatric Patients

Advise the caregiver or the patient of the following:

- To always give this medicine exactly as the child's physician or pharmacist has instructed them.
- The importance of keeping scheduled physician's visits. ELIQUIS dose is based on body weight and the dose may need to be adjusted as the child's weight changes. This ensures that the child receives the correct dose of ELIQUIS. The physician may adjust the child's dose when needed. The caregiver should be advised not to adjust the dose themselves.
- What to do if the child vomits or spits up. If a child vomits or spits up within 30 minutes after taking ELIQUIS, repeat the dose. If a child vomits or spits up more than 30 minutes after taking ELIQUIS, do not repeat the dose. Continue to give the next ELIQUIS dose at the next scheduled time. The caregiver should contact the physician if the child repeatedly vomits or spits up after taking ELIQUIS.

Marketed by:

Bristol-Myers Squibb Company
Princeton, NJ 08543 USA

and

Pfizer Inc
New York, NY 10001 USA

Rotachrom® is a registered trademark of Diagnostica Stago.

[PRINT CODES]

MEDICATION GUIDE

ELIQUIS® (ELL eh kwiss)
(apixaban)
tablets

ELIQUIS® (ELL eh kwiss) **SPRINKLE** (SPRINK el)
(apixaban)
for oral suspension

What is the most important information I should know about ELIQUIS?

ELIQUIS may cause serious side effects, including:

- **Increased risk of blood clots if you stop taking ELIQUIS.**

ELIQUIS lowers your chance of having a stroke by helping to prevent clots from forming. If you stop taking ELIQUIS, you may have increased risk of forming a clot in your blood.

Do not stop taking ELIQUIS without talking to the healthcare provider who prescribes it for you. Stopping ELIQUIS increases your risk of having a stroke.

ELIQUIS may need to be stopped, if possible, prior to surgery or a medical or dental procedure. Ask the healthcare provider who prescribed ELIQUIS for you when you should stop taking it. Your healthcare provider will tell you when you may start taking ELIQUIS again after your surgery or procedure. If you have to stop taking ELIQUIS, your healthcare provider may prescribe another medicine to help prevent a blood clot from forming.

- **Increased risk of bleeding.** ELIQUIS can cause bleeding which can be serious and may lead to death. This is because ELIQUIS is a blood thinner medicine that reduces blood clotting.

You may have a higher risk of bleeding if you take ELIQUIS and take other medicines that increase your risk of bleeding, including:

- aspirin or aspirin-containing products
- long-term (chronic) use of nonsteroidal anti-inflammatory drugs (NSAIDs)
- warfarin sodium
- any medicine that contains heparin
- clopidogrel
- selective serotonin reuptake inhibitors (SSRIs) or serotonin norepinephrine reuptake inhibitors (SNRIs)
- other medicines to help prevent or treat blood clots

Tell your healthcare provider if you take any of these medicines. Ask your healthcare provider or pharmacist if you are not sure if your medicine is one listed above.

During treatment with ELIQUIS:

- you may bruise more easily
- it may take longer than usual for any bleeding to stop

Call your healthcare provider or get medical help right away if you or your child develop any of these signs or symptoms of bleeding during treatment with ELIQUIS:

- unexpected bleeding or bruising, or bleeding that lasts a long time, such as:
 - unusual bleeding from the gums
 - nosebleeds that happen often
 - menstrual bleeding or vaginal bleeding that is heavier than normal
- bleeding that is severe or you cannot control
- red, pink, or brown urine
- red or black stools (looks like tar)
- cough up blood or blood clots
- vomit blood or your vomit looks like “coffee grounds”
- unexpected pain, swelling, or joint pain
- headaches, feeling dizzy or weak

- **Spinal or epidural blood clots (hematoma).** People who take a blood thinner medicine (anticoagulant) like ELIQUIS, and have medicine injected into their spinal and epidural area, or have a spinal puncture have a risk of forming a blood clot that can cause long-term or permanent loss of the ability to move (paralysis). Your risk of developing a spinal or epidural blood clot is higher if:

- a thin tube called an epidural catheter is placed in your back to give you certain medicine
- you take NSAIDs or a medicine to prevent blood from clotting
- you have a history of difficult or repeated epidural or spinal punctures
- you have a history of problems with your spine or have had surgery on your spine

If you take ELIQUIS and receive spinal anesthesia or have a spinal puncture, your healthcare provider should watch you closely for symptoms of spinal or epidural blood clots or bleeding. Tell your healthcare provider or get medical help right away if you have back pain, tingling, numbness, or muscle weakness, especially in your legs and feet, or loss of control of the bowels or bladder (incontinence).

- ELIQUIS is not for use in people with artificial heart valves.

- ELIQUIS is not for use in people with antiphospholipid syndrome (APS), especially with positive triple antibody testing.

What is ELIQUIS?

ELIQUIS is a prescription medicine used in adults to:

- reduce the risk of stroke and blood clots in people who have atrial fibrillation (a type of irregular heartbeat) that is not caused by a heart valve problem.
- help prevent a blood clot in the veins of your legs (deep vein thrombosis or DVT) and lungs (pulmonary embolism or PE) of people who have just had hip or knee replacement surgery.
- treat deep vein thrombosis (DVT) or pulmonary embolism (PE)
- reduce the risk of DVT or PE from happening again after receiving treatment for blood clots.

ELIQUIS is used in children from birth and older to treat blood clots in the veins of your legs and lungs (venous thromboembolism) after at least 5 days of initial anticoagulant treatment, and to reduce the risk of them happening again.

ELIQUIS was not studied and is not recommended in children who weigh less than 5.7 pounds (2.6 kg).

Do not take ELIQUIS if you or your child:

- currently have certain types of abnormal bleeding.
- have had a severe allergic reaction to apixaban or any of the ingredients in ELIQUIS. Ask your healthcare provider if you are not sure. See the end of this Medication Guide for a complete list of ingredients in ELIQUIS.

Before taking ELIQUIS, tell your healthcare provider about all of your medical conditions, including if you or your child:

- have or ever had bleeding problems
- have kidney or liver problems
- have antiphospholipid syndrome (APS)
- are pregnant or plan to become pregnant. It is not known if ELIQUIS will harm your unborn baby.
 - **Tell your healthcare provider** right away if you become pregnant during treatment with ELIQUIS. Taking ELIQUIS during pregnancy may increase the risk of bleeding in you or in your unborn baby.
 - **Females who are able to become pregnant:** Talk with your healthcare provider about pregnancy planning during treatment with ELIQUIS. Talk with your healthcare provider about your risk for severe uterine bleeding if you are treated with ELIQUIS.
 - If you take ELIQUIS during pregnancy, tell your healthcare provider right away if you develop any signs or symptoms of bleeding or blood loss. See **“What is the most important information I should know about ELIQUIS?” for signs and symptoms of bleeding.**
- are breastfeeding or plan to breastfeed. It is not known if ELIQUIS passes into your breast milk. Do not breastfeed during treatment with ELIQUIS. Talk to your healthcare provider about the best way to feed your baby during treatment with ELIQUIS.

Tell all of your healthcare providers and dentists that you or your child are taking ELIQUIS. They should talk to the healthcare provider who prescribed ELIQUIS for you, before you have **any** surgery, medical or dental procedure.

Tell your healthcare provider about all the medicines you or your child take, including prescription and over-the-counter medicines, vitamins, and herbal supplements.

Some of your other medicines may affect the way ELIQUIS works, causing side effects. Certain medicines may increase your risk of bleeding or stroke when taken with ELIQUIS. See **“What is the most important information I should know about ELIQUIS?”**

Know the medicines you take. Keep a list of them to show your healthcare provider and pharmacist when you get a new medicine.

How should I take ELIQUIS?

- **Take ELIQUIS exactly as prescribed by your healthcare provider.**
- Take ELIQUIS 2 times every day.
- Do not change your dose or stop taking ELIQUIS unless your healthcare provider tells you to.
- If you or your child misses a dose of ELIQUIS, take it as soon as you remember on the same day. Do not take 2 doses of ELIQUIS at the same time to make up for a missed dose. Return to your usual dosing schedule the next day.
- For adults and children weighing at least 77 pounds (35 kg), if you have trouble swallowing the tablet whole, talk to your healthcare provider about other ways to take ELIQUIS tablets.
- Your healthcare provider will decide how long you should take ELIQUIS. **Do not stop taking it without first talking with your healthcare provider.**
- **Do not run out of ELIQUIS. Refill your prescription before you run out.** When leaving the hospital following hip or knee replacement, be sure that you will have ELIQUIS available to avoid missing any doses.
- If you take too much ELIQUIS, call your healthcare provider or go to the nearest hospital emergency room right away.

- Call your healthcare provider or healthcare provider right away if you fall or injure yourself, especially if you hit your head. Your healthcare provider or healthcare provider may need to check you.

For children who take ELIQUIS:

- **See the detailed Instructions for Use that comes with ELIQUIS SPRINKLE for oral suspension or ELIQUIS tablets for oral suspension for information on how to prepare and give a dose of ELIQUIS** to children who weigh less than 77 pounds (35 kg).
- Always give ELIQUIS exactly as your child's healthcare provider or pharmacist has told you.
- The dose of ELIQUIS is based on your child's body weight. Your child's healthcare provider may need to change your child's dose as their weight changes. Do not change your child's dose without talking with the healthcare provider.
- If a child vomits or spits up within 30 minutes after taking ELIQUIS, repeat the dose. If a child vomits or spits up more than 30 minutes after taking ELIQUIS, do not repeat the dose. Continue to give the next ELIQUIS dose at the next scheduled time.
- Contact the healthcare provider if your child repeatedly vomits or spits up after taking ELIQUIS.

What are the possible side effects of ELIQUIS?

- See **"What is the most important information I should know about ELIQUIS?"**

The most common side effect of ELIQUIS in adults was bleeding.

The most common side effect of ELIQUIS in children include:

- headache
- vomiting
- heavy menstrual bleeding

These are not all of the possible side effects of ELIQUIS.

Call your doctor for medical advice about side effects. You may report side effects to FDA at 1-800-FDA-1088.

How should I store ELIQUIS?

Store ELIQUIS at room temperature between 68°F to 77°F (20°C to 25°C).

Keep ELIQUIS and all medicines out of the reach of children.

General Information about the safe and effective use of ELIQUIS.

Medicines are sometimes prescribed for purposes other than those listed in a Medication Guide. Do not use ELIQUIS for a condition for which it was not prescribed. Do not give ELIQUIS to other people, even if they have the same symptoms that you have. It may harm them. You can ask your pharmacist or healthcare provider for information about ELIQUIS that is written for health professionals.

What are the ingredients in ELIQUIS?

Active ingredient: apixaban

Inactive ingredients:

ELIQUIS tablets 2.5 mg and 5 mg: anhydrous lactose, croscarmellose sodium, magnesium stearate, microcrystalline cellulose, and sodium lauryl sulfate. The film coating contains hypromellose, lactose monohydrate, titanium dioxide, triacetin, and yellow iron oxide (2.5 mg tablets) or red iron oxide (5 mg tablets).

ELIQUIS 0.5 mg film coated tablets for oral suspension: anhydrous lactose, croscarmellose sodium, magnesium stearate, microcrystalline cellulose, sodium lauryl sulfate. The film coating contains hypromellose, lactose monohydrate, red iron oxide, titanium dioxide, and triacetin.

ELIQUIS SPRINKLE 0.15 mg for oral suspension: contains hypromellose and sugar spheres.

Marketed by:
Bristol-Myers Squibb Company
Princeton, NJ 08543 USA
and
Pfizer Inc
New York, NY 10001 USA

All other trademarks are property of their respective companies.

For more information, call 1-855-354-7847 (1-855-ELIQUIS) or go to www.ELIQUIS.com.

This Medication Guide has been approved by the U.S. Food and Drug Administration.

Revised 04/2025

INSTRUCTIONS FOR USE
ELIQUIS® (ELL EH KWISS)
(APIXABAN)
TABLETS
FOR ORAL SUSPENSION

Important information you need to know before giving a dose of ELIQUIS tablets for oral suspension (ELIQUIS tablets):

- Read this Instructions for Use carefully before you prepare and give a dose of ELIQUIS tablets for the first time and each time you get a refill. There may be new information.
- This Instructions for Use does not take the place of talking with your healthcare provider about your child's medical condition and treatment.
- Your healthcare provider or pharmacist should show you how to prepare and give a dose of ELIQUIS tablets. Always give this medicine exactly as your child's healthcare provider or pharmacist has told you.
- If you have any questions about how to prepare or give a dose of ELIQUIS tablets, talk to the healthcare provider or pharmacist.
- Mix ELIQUIS tablets with food or liquid to give medicine. **Do not** swallow tablets.
- If given with liquid, give the medicine right away or within 2 hours of preparation.
- If given with food, give the medicine right away after preparation.
- If your child vomits or spits up within 30 minutes after taking ELIQUIS, repeat the dose. If your child vomits or spits up more than 30 minutes after taking ELIQUIS, do not repeat the dose.
- Contact the doctor if your child repeatedly vomits or spits up after taking ELIQUIS.
- For children who have difficulty swallowing, the liquid mixture can be delivered through a gastrostomy tube (G tube) or nasogastric tube (NG tube).
- **For more information about ELIQUIS or if you have any questions, see the Medication Guide and talk with your healthcare provider.**

Preparing the prescribed dose of ELIQUIS tablets

There are 2 ways you can mix and give ELIQUIS tablets:

- **With liquid** method, using an oral dosing syringe, **or**
- **With food** method, using a small bowl and spoon.

You will need a medicine cup and oral dosing syringe (liquid mixing method) **or** a cup and small spoon (food mixing method) to give this medicine.

Liquid Mixing Method

❑ **Step 1: Prepare Supplies**

- **Wash and dry your hands.**
- **Clean and prepare a flat work surface.**
- **Gather your supplies:**
 - **Packet(s)** (check prescription label for the number of packet(s) needed for the prescribed dose).
 - Oral dosing syringe (to give medicine to your child)
 - Medicine cup (to mix medicine)
 - Small spoon (to mix medicine)
 - Small scissors (to open packet)
 - **Mixing liquid** (use infant formula, water or apple juice).

You can ask your pharmacist for the oral dosing syringe and medicine cup.

Packet(s)
Small spoon
(not included)



Medicine cup
(not included)



Oral dosing syringe
(not included)

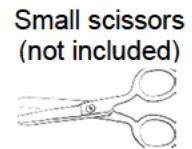

Mixing liquid (use infant formula, water or apple juice)
(not included)

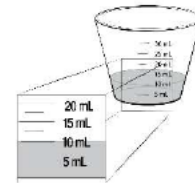

❑ **Step 2: Check prescription label for prescribed dose**





- Check the prescription label for the number of packet(s) needed for the prescribed dose.
- Repeat Step 3 and Step 4, if needed, to get the full prescribed dose.

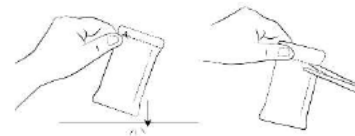

❑ **Step 3: Tap and open packet**

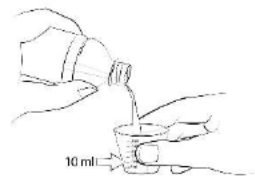
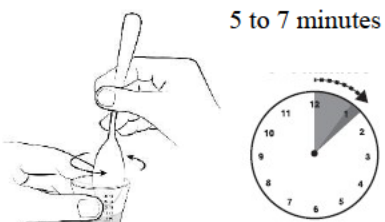
- **Tap** packet to move the tablet(s) inside to the bottom.
- **Cut** the dotted line on the packet to open it.



<p>❑ Step 4: Empty the packet</p> <ul style="list-style-type: none"> • Empty the tablet(s) inside the packet into the medicine cup. • Run your finger over the packet to remove all the tablet(s). 		
<p>❑ Step 5: Add liquid to the medicine cup</p> <ul style="list-style-type: none"> • You will need 10 mL (2 teaspoons) of liquid total, regardless of the number of packets(s) prescribed. • For children with fluid restrictions, your healthcare provider will tell you if you can use 2.5 mL of liquid. <p>Use water, infant formula, or apple juice only as the liquid. Do not use any other type of liquid.</p> <p>Important: To make sure your child gets the full dose, do not put the medicine in a baby bottle.</p>		
<p>❑ Step 6: Mix medicine and liquid</p> <ul style="list-style-type: none"> • Hold the medicine cup with one hand. • Use a small spoon crush the tablet(s) and stir the medicine in the liquid. • Continue to stir until tablet(s) are no longer visible throughout the liquid. This should take about 5 to 7 minutes. 		
<p>❑ Step 7: Give oral suspension This is a 2-part process to make sure all the medicine is given. Follow Part 1 and Part 2.</p> <p>Part 1: Pull up all liquid mixture with the oral dosing syringe and give all medicine in syringe.</p>		
<p>Push plunger all the way down.</p> 	<p>Place the syringe tip into the cup and pull up all the liquid mixture.</p> 	<p>With the child seated upright or slightly inclined (tilted back), place the oral syringe into the mouth with the tip along either cheek.</p> <p>Slowly push the plunger all the way down to give all medicine in the syringe.</p> 
<p>Part 2: Repeat Steps 5 through 7 to give any remaining medicine in the cup:</p>		

Add about 5 mL (1 teaspoon) liquid to medicine cup.

For children with fluid restrictions, your healthcare provider will tell you if you can use 2.5 mL (½ teaspoon) of liquid.

Gently stir liquid with small spoon.

Push plunger all the way down.

Place the syringe tip into cup and pull up all the liquid mixture.

With the child seated upright or slightly inclined (tilted back), place the oral syringe into the mouth with the tip along either cheek.

Slowly push the plunger all the way down to give all medicine in the syringe.



Step 8: Washing parts

- Throw away the empty packet(s) into the household trash.
- Remove the syringe plunger from the syringe barrel.
- Use only clean water to rinse the syringe parts, the medicine cup and small spoon.
- Put the syringe plunger back into the syringe barrel when dry.



Food Mixing Method

Step 1: Prepare Supplies



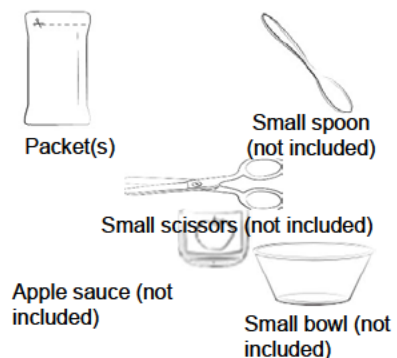

- Wash and dry your hands.
- Clean and prepare flat work surface.
- Gather your supplies:
 - Packet(s) (check the prescription for the number of packet(s) needed for the prescribed dose).
 - Small bowl (to mix medicine)
 - Small spoon (to mix medicine)
 - Small scissors (to open packet)
 - Apple sauce

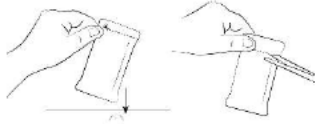

Step 2: Check prescription label for prescribed dose

- Check the prescription label for the number of packet(s) needed for the prescribed dose.
- Repeat Step 3 and Step 4, if needed, to get the full prescribed dose



<p>❑ Step 3: Prepare for mixing</p> <ul style="list-style-type: none"> • Add approximately 15 mL (1 tablespoon) of applesauce to bowl. 	
<p>❑ Step 4: Tap and open packet</p> <ul style="list-style-type: none"> • Tap packet to move the tablet(s) inside to the bottom. • Cut the dotted line on the packet to open it. 	
<p>❑ Step 5: Empty the packet</p> <ul style="list-style-type: none"> • Empty the tablet(s) inside the packet into the bowl. • Run your finger over the packet to remove all tablet(s). 	
<p>❑ Step 6: Mix medicine and food</p> <ul style="list-style-type: none"> • Hold the small bowl with one hand and use a small spoon to stir the tablet(s) into the apple sauce. <p>The tablet(s) do not need to disperse (evenly mix) in the food.</p>	
<p>❑ Step 7: Give medicine</p> <ul style="list-style-type: none"> • With the child seated upright or slightly inclined (tilted back), give food and medicine mixture by small spoon into the mouth • Ensure all medicine and food have been given so no medicine is left in the bowl. 	

❑ **Step 8: Washing parts**

- **Throw** away the empty packet(s) into the household trash.
- **Wash** cup, small bowl and small spoon with soap and clean water. Let all items dry before next use.

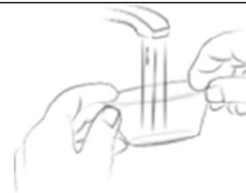

Giving ELIQUIS tablets prepared as a suspension through a nasogastric tube (NG tube) or gastrostomy tube (G tube):

Follow steps 1 through 6 to prepare the dose to be given. Follow the manufacturer instructions for how to place the syringe tip into the tube and give the medicine to your child. After the medicine has been placed into the tube, using the syringe flush the tube with additional water or infant formula. The flush volume is shown in the table below.

Tube Size (French)	Volume (mL)
5	10
6.5	15
12	25

Talk to your healthcare provider if you have any questions.

How should I store ELIQUIS tablets?

Store ELIQUIS at room temperature between 68°F to 77°F (20°C to 25°C).

Keep ELIQUIS and all medicines out of the reach of children.

Marketed by:
Bristol-Myers Squibb Company Princeton, NJ 08543 USA
and
Pfizer Inc New York, NY 10001 USA
All other trademarks are property of their respective companies.

For more information, call 1-855-354-7847 (1-855-ELIQUIS) or go to www.ELIQUIS.com.

This Instructions for Use has been approved by the U.S. Food and Drug Administration.

Issued: 04/2025

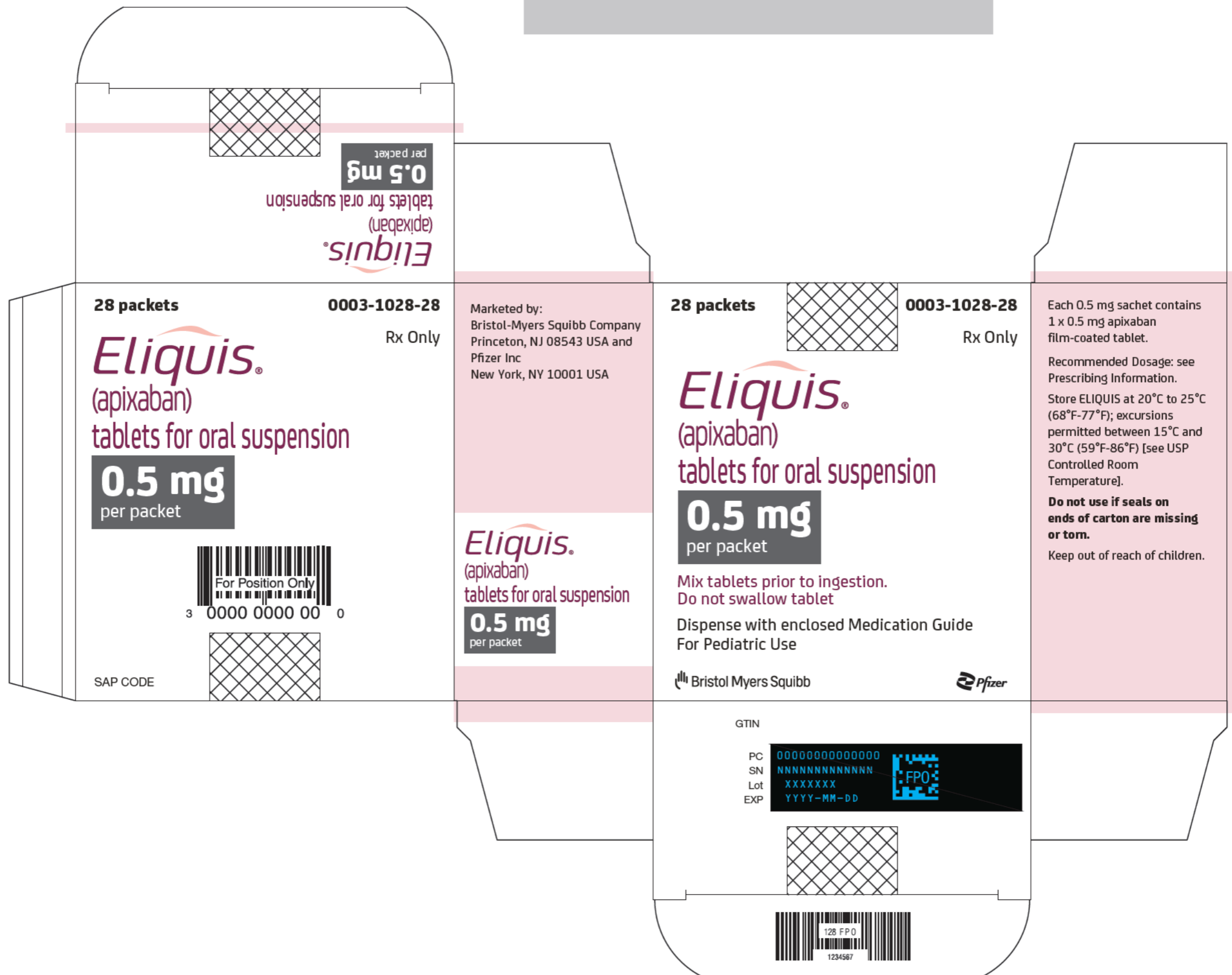

Eliquis.
(apixaban)
tablets for oral suspension
0.5 mg
per packet

28 packets

0003-1028-28

Rx Only

Eliquis.
(apixaban)
tablets for oral suspension

0.5 mg
per packet



SAP CODE

Marketed by:
Bristol-Myers Squibb Company
Princeton, NJ 08543 USA and
Pfizer Inc
New York, NY 10001 USA

Eliquis.
(apixaban)
tablets for oral suspension
0.5 mg
per packet

28 packets

0003-1028-28

Rx Only

Eliquis.
(apixaban)
tablets for oral suspension

0.5 mg
per packet

Mix tablets prior to ingestion.
Do not swallow tablet

Dispense with enclosed Medication Guide
For Pediatric Use

Bristol Myers Squibb

Pfizer

Each 0.5 mg sachet contains
1 x 0.5 mg apixaban
film-coated tablet.

Recommended Dosage: see
Prescribing Information.

Store ELIQUIS at 20°C to 25°C
(68°F-77°F); excursions
permitted between 15°C and
30°C (59°F-86°F) [see USP
Controlled Room
Temperature].

**Do not use if seals on
ends of carton are missing
or torn.**

Keep out of reach of children.

GTIN

PC 00000000000000
SN NNNNNNNNNNNN
Lot XXXXXX
EXP YYYY-MM-DD



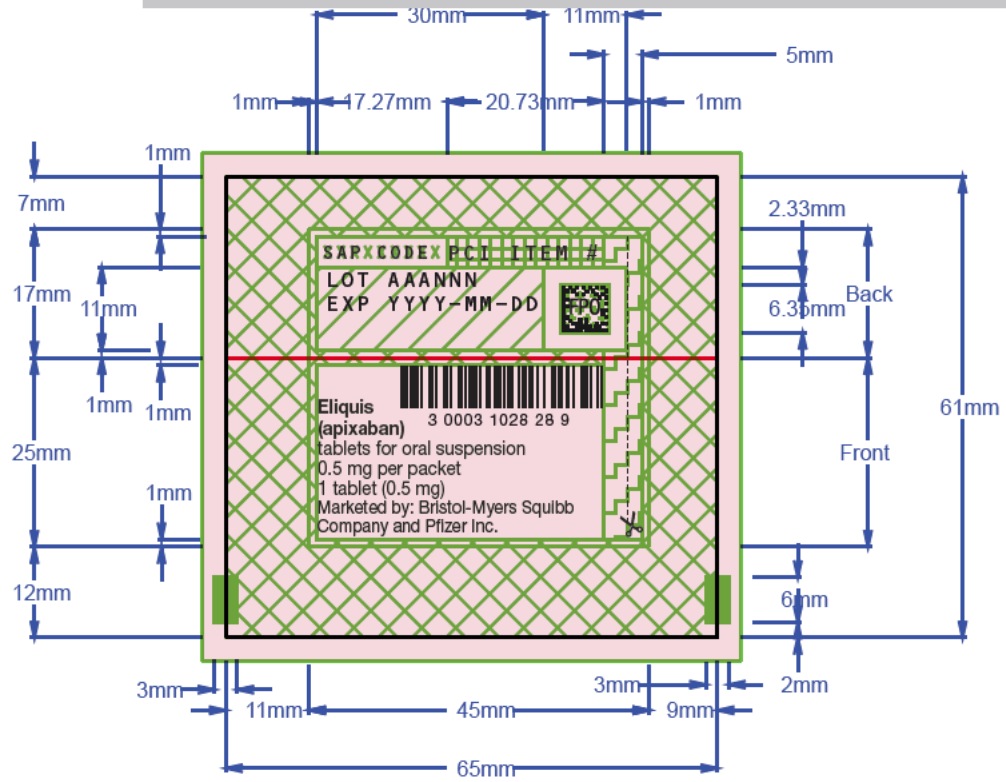

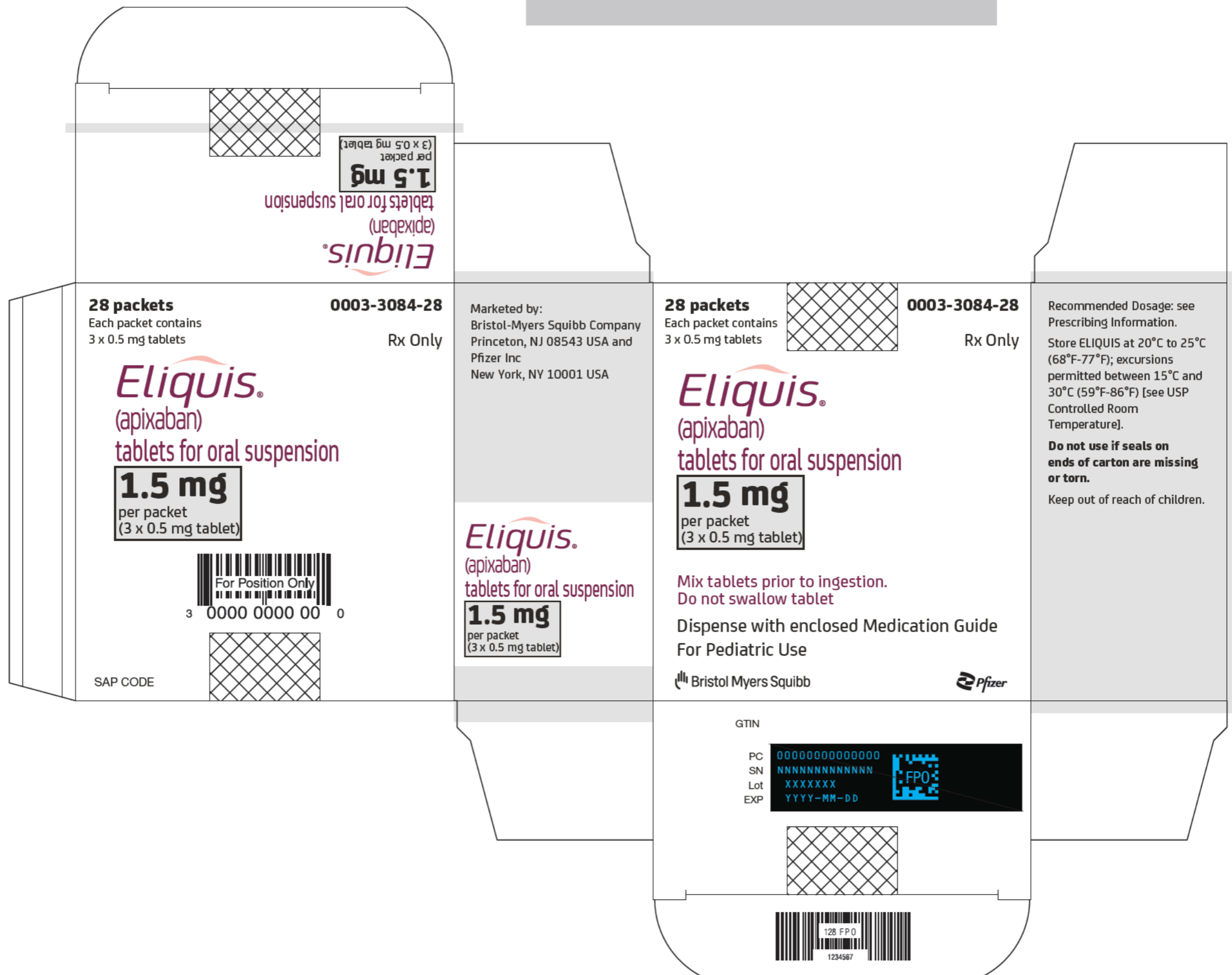

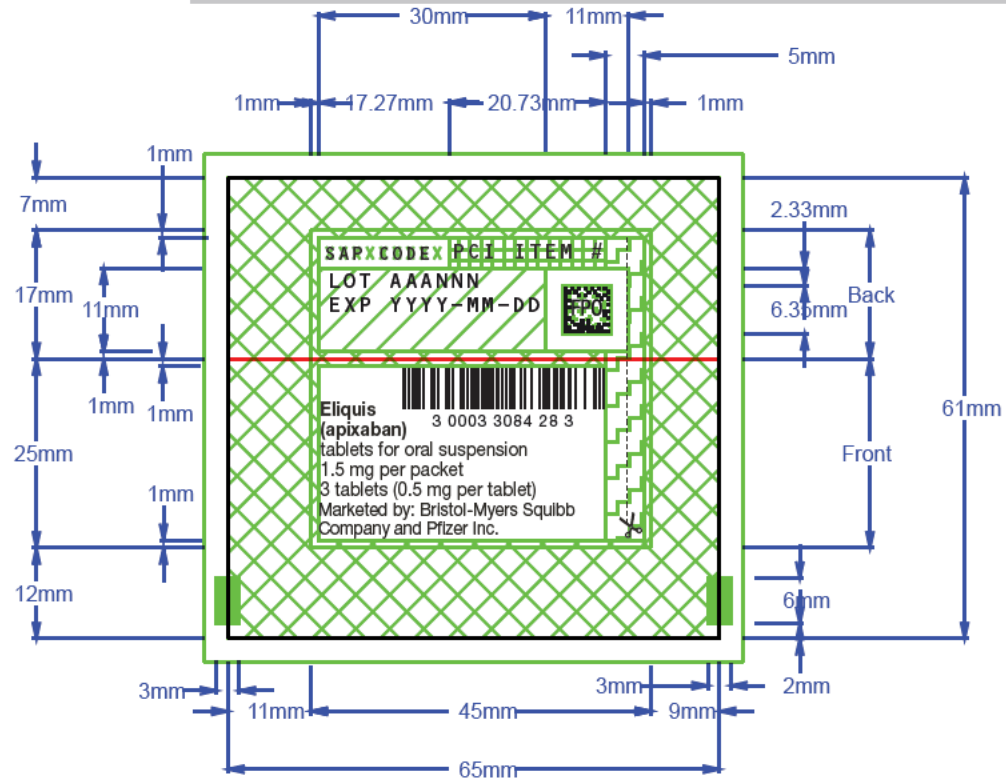

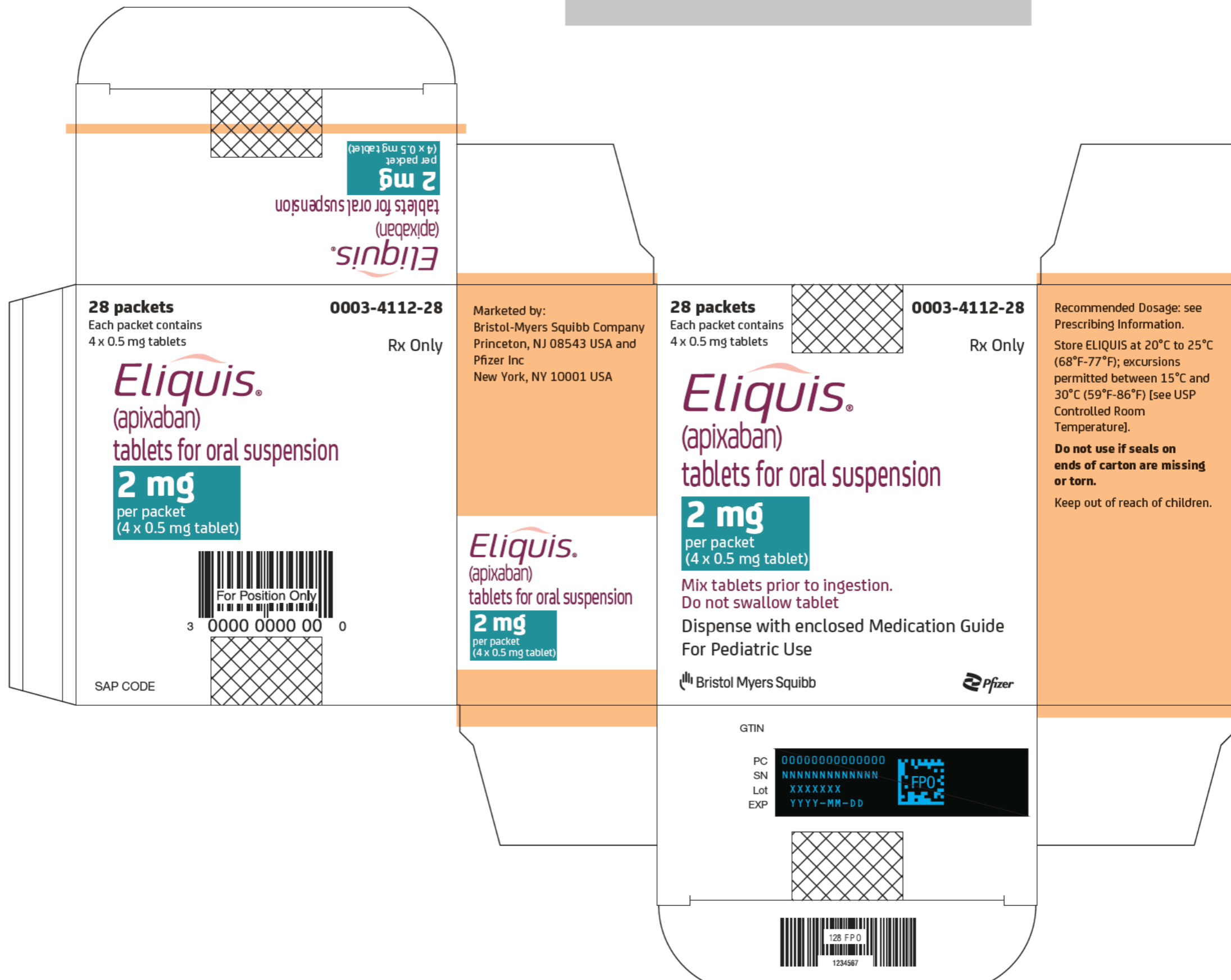

28 packets

Each packet contains
4 x 0.5 mg tablets

0003-4112-28

Rx Only

Eliquis.
(apixaban)
tablets for oral suspension

2 mg
per packet
(4 x 0.5 mg tablet)



SAP CODE

Marketed by:
Bristol-Myers Squibb Company
Princeton, NJ 08543 USA and
Pfizer Inc
New York, NY 10001 USA

28 packets

Each packet contains
4 x 0.5 mg tablets

0003-4112-28

Rx Only

Eliquis.
(apixaban)
tablets for oral suspension

2 mg
per packet
(4 x 0.5 mg tablet)

Mix tablets prior to ingestion.
Do not swallow tablet

Dispense with enclosed Medication Guide
For Pediatric Use

Bristol Myers Squibb

Pfizer

Recommended Dosage: see
Prescribing Information.
Store ELIQUIS at 20°C to 25°C
(68°F-77°F); excursions
permitted between 15°C and
30°C (59°F-86°F) [see USP
Controlled Room
Temperature].
**Do not use if seals on
ends of carton are missing
or torn.**
Keep out of reach of children.

GTIN

PC 00000000000000
SN NNNNNNNNNNNN
Lot XXXXXX
EXP YYYY-MM-DD



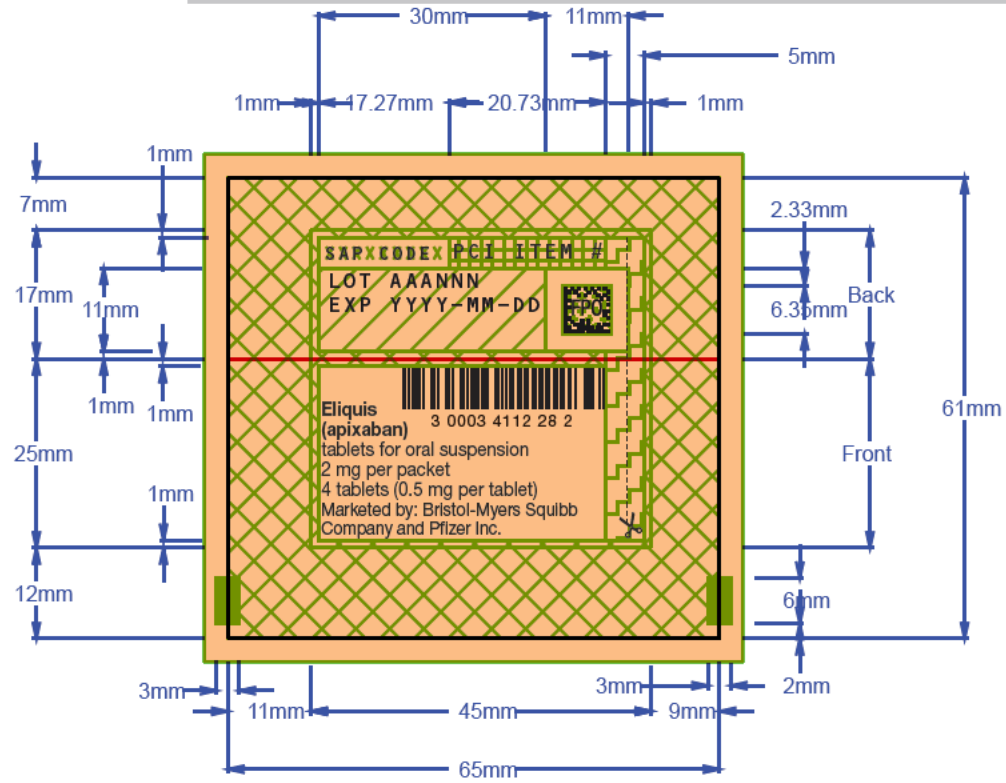

This is a representation of an electronic record that was signed electronically. Following this are manifestations of any and all electronic signatures for this electronic record.

/s/

TANYA M WROBLEWSKI
04/17/2025 04:18:01 PM